

VRLA HANDBOOK

ENGLISH

INDUSTRIAL BATTERIES



PANASONIC BATTERIES



PANASONIC INDUSTRIAL EUROPE

Panasonic Corporation, founded in Osaka 1918, is one of the world's largest manufacturers of quality electronic and electrical equipment. Its subsidiary, Panasonic Industrial Europe GmbH (PIE) deals with a wide diversified range of industrial products for all European countries. This company was formed in 1998 to strengthen Panasonic's Pan-European industry operation, and today is active in such different business fields as Automotive, Audio/Video & Communication, Appliance and Industry & Devices to satisfy its customer's needs.



Panasonic quality - certified by authorised companies.

We are able to offer you a wide range of individual power solutions for portable and stationary applications. Our product range includes high reliability batteries such as Lithium-Ion, Lithium, Nickel-Metal-Hydride, Valve-Regulated-Lead-Acid (VRLA), Alkaline and Zinc-Carbon. Based on this battery range we can power your business in virtually all applications.

Panasonic Energy Company (PEC) started its battery production in 1931. Today PEC is the most diversified global battery manufacturer with a network of 20 manufacturing companies in 14 countries. More than 16,000 employees are dedicated to the research & development and in the production of new batteries for a new world.

When it comes to production our facilities employ leading edge manufacturing processes meeting the highest quality standards. Our factories are certified to ISO standards. This means that each factory has its own quality and environmental management. The ISO 9000 and ISO 14000 series are the minimum benchmarks that ensure our excellent product reliability.

Furthermore the majority of our factories is also certified to OHSAS 18001 (Occupational Health and Safety Assessment Series), an international standard for assessing a management system for occupational safety. This confirms that our factories have been proactive in putting the occupational health and safety of its staff at the centre of the company's dealings. In addition our VRLA batteries are for example approved to German VdS standard and U.S. UL standard.

PIE Organisation Divisions

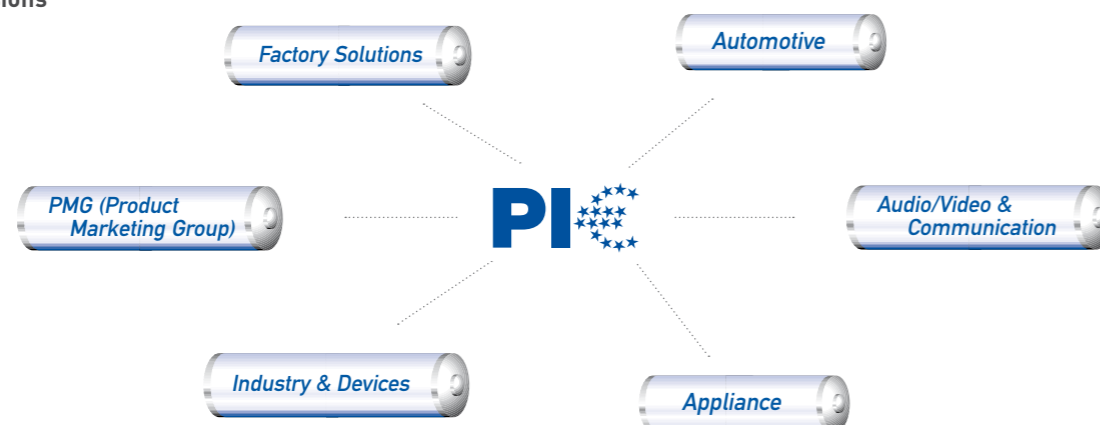



PANASONIC LEADS THE WAY ... WITH 'ECO IDEAS'

Pursuing coexistence with the global environment in its business vision, Panasonic places reduction of the environmental impact in all its business activities as one of the important themes in its mid-term management plan. In its 'eco ideas' Strategy, which focuses in particular on rapid implementation of measures to prevent global warming and global promotion of environmental sustainability management, Panasonic is advancing three key initiatives: 'eco ideas' for Manufacturing, 'eco ideas' for Products, and 'eco ideas' for Everybody, Everywhere.

i

Our **energy** will Drive **eco** Innovation.

THE PANASONIC 'ECO IDEAS' HOUSE

We are approaching a global turning corner and it would not be an exaggeration to call it the 'Environmental Industrial Revolution'. Based on this recognition, Panasonic has built an 'eco ideas' House on the premise of our showroom, Panasonic Center Tokyo in April 2009 in order to help create a carbon-free society and reduce CO₂ emissions from a household sector.

The concept of this 'eco ideas' House can be described as follows:

1. Virtually zero CO₂ emissions in an entire house envisaged in three to five years into the future
 2. Synergy of technology and nature
- Aforementioned concepts shows that Panasonic is not only aware of it's environmental responsibility moreover this Panasonic takes action.

'ECO IDEAS' FOR MANUFACTURING

Our Plans

We will reduce CO₂ emissions across all our manufacturing sites.

Our Goals

In each of our factories a CO₂ emissions of 10% reduction till 2010.

Our Measures

Our factories are evaluated with regard to CO₂ emission, waste disposal, recycling measures as well as chemical and water consumption within the scope of the 'Clean Factory' program and they are set performance targets according to these indicators.

Example

The Wakayama Plant of the Energy Company is strengthening its management structure to cut CO₂ emissions from the main production bases for Lithium-Ion batteries, which are a core component of Panasonic's energy business. As a result, it has succeeded in roughly halving CO₂ emissions per production unit, as well as sharply curbing an increase in CO₂ emissions even as production has expanded.

'ECO IDEAS' FOR PRODUCTS

Our Plans

We will produce energy-efficient products.

Our Goals

In March 2010 at least 20 products with the 'Superior Green Products' classification should be available.

Our Measures

The developers at Panasonic carry out an environmental impact assessment for all our products. Products that meet the highest environmental requirements in the branch with regard to conservation of energy and energy efficiency are classified as a 'Superior Green Product' and awarded the Panasonic logo 'eco ideas'.

Example

We have dispensed with the use of highly toxic Lithium Thionyl Chloride in the production of our Lithium batteries. This is quite rightly classified as highly toxic and should never under any circumstances be released into the environment.

'ECO IDEAS' FOR EVERYBODY, EVERYWHERE

Our Plans

We will encourage the spread of environmental activities throughout the world.

Our Goals

Intensive commitment on the part of the company owners, international cooperations and involvement of the employees.

Our Measures

Not only do we sponsor the work of the WWF for the Arctic, Panasonic has also launched a couple of other environmental initiatives such as the ECO RELAY initiative in which hundreds of colleagues the world over take part voluntarily for several days in environmental campaigns.

Example

With the support of the GRS Batterien (German Battery Recycling Association) Panasonic arranged a battery collection day with the aim of collecting as many of these spent energy sources as possible and giving out information about the recycling loop of batteries from which valuable raw materials such as Zinc, Manganese and Iron can be recovered.

Index

1 Precautions for Handling	page	7 – 12
2 General Information	page	13 – 15
3 Characteristics	page	16 – 18
4 Charging Methods	page	19 – 23
5 Terminal Data	page	23
6 Safety	page	24
7 Safety Design	page	24 – 25
8 Model Numbers	page	26 – 27
9 Battery Selection Chart	page	28 – 29
10 Battery Selection Guide	page	30
11 Battery Index	page	31 – 32
12 Standards	page	33 – 34
13 Individual Data Sheets	page	35 – 135
14 Glossary	page	136 – 137

1 | Precautions for Handling VRLA-Batteries

This document should be read in its entirety and its contents fully understood before handling or using Panasonic rechargeable sealed Lead-Acid batteries. If there are any questions, please contact Panasonic. Please keep this document available for reference. Due to the potential energy stored in the batteries, improper handling or use of the batteries without understanding this document may result in injury caused by electrolyte leakage, heat generation, or explosion.

* All descriptions are subject to change without notice.

Degree of danger

1. DANGER

When the batteries are handled or used improperly, death or severe injury may occur.

2. WARNING

When the batteries are handled or used improperly, death or severe injury may occur, and sight injury or loss of products often occur.

3. CAUTION

When the batteries are handled or used improperly, slight injury may occur and damage to the batteries and equipment may occur.

4. REQUEST

When the batteries are handled or used improperly, damage to quality or performance may occur.

Note (1):

Improper handling and use of the batteries may cause dangerous conditions to arise. All precautions should be taken to prevent any harmful effects from the use of the batteries.

Note (2):

“Severe injury” as a result of improper handling or use of the batteries may include but are not limited to loss of eyesight, injury/burn/electric shock/fracture of a bone/poisoning with after effect, or injury that requires long-term medical treatment. “Slight injury” covers such conditions as burns or electric shock that do not require long-term medical treatment. Damage to products is defined as extensive damage to a house, a house hold effects, a livestock, or pets.

Note (3):

“Requests” are meant to prevent a decrease in the quality or the performance of the batteries.

1 | Precautions for Handling VRLA-Batteries

1. Environment and Condition

DANGER

(1) Do not put the batteries into airtight containers or bags. The batteries tend to generate inflammable gas upon excess charge which may cause an explosion if enclosed in an airtight container.

WARNING

(1) The batteries must be charged using the specified charger or by maintaining the charging conditions indicated by Panasonic. If the batteries are charged under conditions other than those specified by Panasonic, they may leak, generate excessive heat, or explode.

(2) When using the batteries in medical equipment, incorporate a back-up system other than the main battery in the event of power failure.

(3) Insert insulation that is resistant to heat and sulfuric acid between the batteries and any metallic housing. Failure to do so may cause the batteries to smoke or burn in case of electrolyte leakage.

(4) Do not place the batteries near a device that may generate sparks (such as a switch or fuse) and do not place the batteries close to fire. The batteries may generate an inflammable gas when charged excessively that may ignite upon contact with a spark or they may burn or explode due to sparks or fire.

CAUTION

(1) Use or store the batteries in the temperature range: Discharge (operating in application): -15°C ~ 50°C.

Charge: 0°C to 40°C. Storage: -15°C to 40°C.

Temperatures above or below those recommended could result in damage or deformity of the batteries.

(2) Avoid placing batteries near a heat-generating device (such as a transformer) which may cause the batteries to generate excessive heat, leak or explode.

(3) Do not allow the batteries to be exposed to rain or sea water. If the battery terminals should get wet, they may corrode.

(4) Do not use or store the batteries in a car under the blazing sun, in direct sunlight. To do so may cause the batteries to leak, generate excessive heat, or explode.

(5) Do not use or store the batteries in a dusty place as dust may cause them to short between their terminals. When using the batteries in a dusty place, check them periodically.

(6) In applications requiring more than one battery, first connect the batteries together and then connect the batteries to the charger or the load. Be careful to connect the (+)pole of the batteries to the (+)terminal of either the charger or the load. Improperly connecting the batteries, charger, or load may cause an explosion or fire to occur. In some cases, bodily injury may occur.

(7) When handling the batteries, wear steel-tipped shoes to prevent possible injury to the feet if the batteries are accidentally dropped.

REQUEST

(1) Dropping a battery may cause a strong physical shock that may damage the performance of the battery.

(2) Confirm the life of the batteries using the real load and charger. Differences in the charging and the discharging conditions may cause a big difference in the life of the batteries.

2. Installation

DANGER

(1) Tools such as wrenches used to install the batteries should be insulated. Bare metal tools may cause an abnormal short circuit accident to occur resulting in bodily injury, damage to the batteries, explosion or fire.

(2) Do not install the batteries in a room without ventilation. The batteries tend to generate an inflammable gas upon excess charge resulting in an explosion or fire if the room is closed.

WARNING

(1) **Do not contact any plastic or resin (*) which contains a migrating plasticizer with the batteries. Furthermore, avoid using organic solvents such as thinner, gasoline, lamp oil, benzene and liquid detergent to clean the batteries.** The use of any of above materials may cause the containers and/or the covers (ABS resin) of the batteries to crack and leak. This may cause a fire in the worst scenario. Need to make sure the use of material will not cause the containers and/ or the covers (ABS resin) of the batteries to crack due to the migration of plasticizer within the material by asking the manufacturer of the material if necessary.

* Examples for plastic or resin which should be avoided using:

Vinyl chloride, Oily rubber.

* Examples for plastic or resin which is proper for the use:

Polyolefin resin such as polypropylene, polyethylene.

1 | Precautions for Handling VRLA-Batteries

(2) Always use such as rubber gloves when handling batteries with the voltages higher than 45 volts in order to prevent severe bodily injury from occurring.

(3) Do not install the batteries in areas where they may come in contact with water. If the batteries come in contact with water, an electric shock may occur.

CAUTION

(1) During unpacking, handle the batteries carefully and check for cracks, breakage, or electrolyte leakage. Failure to handle carefully may result in damage due to physical shock.

(2) When the batteries are being mounted in the equipment, consider the best position for easy checking, maintenance and replacement. In addition, the batteries should be located in the lowest part of the equipment as possible. The Rechargeable Sealed Lead-Acid batteries, mentioned in this document, are designed for use in any position, but charging the batteries in the upside-down position should be avoided. When these batteries are charged excessively in the upside-down position, leakage of electrolyte from the rubber vents may occur. The upside-down is shown on the left side of the next drawings. In this upside-down position, the mark "Panasonic" on the battery are turned upside down. The drawings are only for explanation of the battery's position; therefore these are not equal to the real appearance of the battery that the specifications describe.

Can be used in the vertical position and the sidedown position (maximum angle of 90 degrees from the normal position).

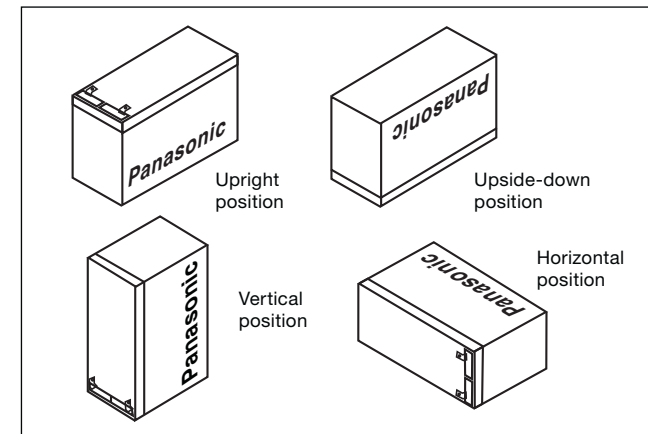

(3) Do not carry the batteries by picking up them by their terminals or lead wires. To do so may damage the batteries.

(4) Be careful not to jolt the batteries as it may result in damage to them.

(5) Be aware the batteries are relatively heavy compared to their volume. Please be careful to carry these batteries in order to avoid injury and/or lumbago.

(6) Do not cover the batteries with plastic sheet as it may cause a fire or an explosion by conducting static electricity.

(7) Fasten the bolts and the nuts with the torque as shown below: Not to do so may cause the battery terminals to break.

Bolt (nut) size (mm)			Fastening torque Nm
Diameter	Pitch	Length	
M5 (5)	0.8	15 ± 1	2.0 – 3.1
M6 (6)	1.0	20 ± 1	4.1 – 5.6
M8 (8)	1.25	20 ± 1	8.2 – 10.2
M10 (10)	1.5	25 ± 1	14.7 – 19.7

(8) Place the necessary insulating covers over the terminals, the connecting bars, and bolts and nuts to prevent a dangerous electric shock.

(9) Please consult Panasonic prior to using the batteries in applications such as a motor bicycle, an engine driven lawn mower, etc. which may generate severe vibration.

(10) Fasten the batteries firmly to the equipment to avoid the influence of vibration and/or physical shock.

REQUEST

(1) The batteries should be installed by a certified technician.

3. Preparation Prior to Operation

DANGER

(1) Be sure to provide enough insulation around the lead wires and/or plates used between the batteries and the application. Insufficient insulation may cause an electric shock heat generating from a short circuit (or excess current) may result in an injury, burn, smoke or fire.

CAUTION

(1) Do not plug the batteries directly into the outlet or the cigarette receptacle of a car without inserting a charger between the batteries and the outlet or the receptacle. To do so may cause electrolyte leakage, heat generation, or explosion of the battery.

(2) Turn off the circuit switch when the connections between the batteries and the charger/load are made.

1 | Precautions for Handling VRLA-Batteries

(3) When using the batteries for the first time, check for rust, heat generation, or any other abnormalities. If found, do not use as it may cause electrolyte leakage, heat generation, or explosion.

REQUEST

(1) Since the batteries tend to lose a part of their capacity due to self-discharge during shipment and storage, recharge the batteries before you use them after purchase or long-term storage in order to restore their full capacity. Check for the following conditions before to recharge:

Charging method	Charging condition (at 20°C)
Constant voltage	<ul style="list-style-type: none"> Regulation range of the controlled voltage: 7.25V to 7.45V / 6V battery, 14.5V to 14.9V / 12V battery; Initial current: 0.1CA to 0.4CA; Maximum charging time: 24 hours. Short-time charge is possible when several batteries of the same model, under the same storage conditions can be charged in series. Otherwise they can be charged separately.
Constant current	<ul style="list-style-type: none"> Charging current: 0.1CA Charging time (hours) = [Amount of self-discharge (Ah)/0.1CA] x 120% Rough estimation of amount of self-discharge is as follows (for an example): When the storage ambient temperature is lower than 20°C, and storage time is known, assume the following amount of self-discharge: [5%/month] x storage months Multiply this by the rated capacity (at 20 hour rate) of the battery. Regardless of the above calculation, the charge time for a refresh charge must be less than 12 hours. When the storage ambient temperature is higher than 20°C, please consult Panasonic.

4. Unspecified Use

CAUTION

(1) Do not place the batteries in an unspecified use or they may leak, generate heat, or explode.

5. Method of Handling and Operation

DANGER

(1) Do not directly connect the positive and negative terminals with a conductive material such as a wire. Be careful

while using a metal tool such as a wrench and/or carrying the batteries with metallic necklaces and hairpins not to make a short circuit. A short of the battery's terminals may cause heat generation, an explosion or a fire.

WARNING

- (1) Never dispose of the batteries in a fire as it may cause them to explode or generate a toxic gas.
- (2) Do not attempt to disassemble the batteries as it could cause leakage of sulfuric acid that could cause injury.

CAUTION

- (1) To prevent accidents from happening, change any battery that is found to have an abnormality such as a crack, a deformity, or leakage. The batteries must be kept clean and free from dust to prevent loss of capacity or accident.
- (2) If any abnormality of the charge voltage or the discharge voltage is detected replace the batteries with new ones.
- (3) Charging the batteries with an inverse polarity connection between the batteries and the charger could cause electrolyte leakage, heat generation, or a fire.
- (4) Do not solder directly on the batteries' terminal tabs. Soldering directly on the batteries' terminals may cause a leak of electrolyte. Consult Panasonic when soldering is necessary.
- (5) Avoid the use of the batteries differing in capacity, type, history of use (charge/discharge operation). These differences could cause electrolyte leakage or heat generation.
- (6) Do not remove or scratch the outer tube of the battery or it may cause an electrolyte leakage or electrical leakage.
- (7) Do not allow the batteries to be subjected to any strong physical shocks or jolts while moving them. Treating the batteries roughly could cause leaks, heat generation, or explosions.
- (8) Do not charge the batteries beyond the amount of the time indicated in the specifications, or do not charge after the charge indication lamp indicates a full charge. Take the batteries off the charger if the charge is not finished after the specified charge time. Over-charging can cause leakage, heat generation, or explosions.
- (9) Children should be taught how to handle and use the batteries correctly.
- (10) Keep the batteries out of the reach of small children at all times.

1 | Precautions for Handling VRLA-Batteries

REQUEST

(1) The cut-off voltage during discharge should vary depending on the discharge current. Do not discharge the batteries lower than the recommended cut-off voltage shown in Panasonic specifications or Panasonic technical handbooks. Recharging a battery which was once discharged below the recommended cut-off voltage may generate heat, resulting in the deformation of the battery or in condensation around the battery cover caused when moisture within the battery evaporates. In addition, the efficiency of the battery would eventually decrease.

Overdischarging a battery may result in reduced performance. Always recharge the batteries immediately after discharge even if the batteries were not discharged to the recommended cut-off voltage. If the batteries are not charged soon after discharge, the batteries performance may be reduced due to the so-called "sulfation phenomena".

Note: The cut-off device to prevent overdischarge should cut off all discharge current including any weak current.

(2) Thoroughly study the charge methods and the conditions of the batteries before adopting other charge methods which are not shown in the Panasonic specifications or the Panasonic technical handbook, for safety reasons.

(3) When the batteries are used in a cyclic application, it is important to charge the batteries for the proper amount of time. A timer should be incorporated into the charging circuit that will disconnect the charging current to prevent overcharging. Also, it is important to allow the battery to completely charge before removing the battery from the charger.

(4) Avoid parallel charging of the batteries in cycle use. This may shorten the life of the batteries by causing an imbalance in the charge/discharge operation of the batteries.

(5) Measure the total voltage of the batteries during trickle charge (or float charge), using a voltage meter. If the total voltage of the batteries provide an indication deviating from the specified voltage range, be sure to investigate the cause. If the total voltage is lower than that specified, the batteries may lose their capacity because of a lack of sufficient charge. However, if the total voltage is higher than that specified, the batteries may lose their capacity by damage due to overcharge and may suffer from "thermal runaway" and other accidents.

(6) Switch off the equipment after use to prevent loss of performance or shortened life of the batteries due to damage overdischarge.

(7) When storing the batteries, be sure to remove them from the equipment or disconnect them from the charger and the load to prevent overdischarge and loss of capacity. Before storing batteries, charge the batteries fully. Do not store batteries in a highly humid place to prevent rust from forming on the terminals.

6. Maintenance

WARNING

(1) When cleaning the batteries, use a soft damp cloth. A dry cloth may cause static electricity which could result in a fire or explosion.

(2) Replace batteries with the new ones before the end of their useful life as determined in the specifications. When the batteries near the end of their life (50% state of their initial discharge duration time) the remaining life will shorten remarkably. Finally the batteries will lose their available capacity by either drying out their electrolyte (causing increase in their internal resistance) or an internal short-circuit. In such case, if the batteries go on charging, thermal runaway and/or leakage of electrolyte may occur. The batteries should be replaced before reaching these conditions.

The expected life of the batteries (in trickle or float use) will decrease to half (50%) with each 10°C rise in temperature above 20°C. In particular, the life of the batteries will be shortened remarkably at approximately 40°C. Accordingly, precautions are required to prevent the use of batteries at high temperatures.

CAUTION

(1) Avoid using organic solvents such as thinner, gasoline, lamp oil or benzene and liquid detergent to clean the batteries. These substances may cause the battery containers to crack or leak.

REQUEST

(1) Keep the battery terminals clean in order to avoid interruption in the discharge and/or to maintain the charge.

1 | Precautions for Handling VRLA-Batteries

7. Treatment at Emergency

WARNING

(1) The batteries have toxic liquid - dilute sulfuric acid solution in them. If the acid comes into contact with skin or clothes, wash skin or cloth with lots of clean water to prevent scalding from occurring. If the acid should come into contact with the eyes, wash the eyes with lots of clean water and consult a physician immediately to prevent possible loss of sight.

CAUTION

(1) Check the batteries visually for any sign of irregularities in appearance. If any damage exists such as cracks, deformation, leakage of electrolyte, or corrosion, the batteries must be replaced with the new ones. Irregularities in the batteries could result in bodily injury, electrolyte leakage, excessive heat generation or explosion, if used. Furthermore, make sure the batteries are clean and free from dirt and dust.

8. Storage

CAUTION

(1) Store the batteries in a fixed position separate from metal or other conductive materials.

(2) Keep the batteries from rain water that could cause corrosion on the terminals of the batteries.

(3) Keep the batteries right-side-up during transportation and do not give any abnormally strong shock and jolt to the batteries. Transporting the batteries in an abnormal position or handling them roughly could destroy the batteries or cause their characteristics to deteriorate.

(4) When storing the batteries, be sure to remove them from the equipment or disconnect them from the charger and the load, then store them at room temperature or lower temperature. Do not store the batteries at direct sunlight, higher temperature or high humidity. To do so cause the batteries short life, performance deterioration or corrosion on terminals.

REQUEST

(1) Charge the batteries at least once every twelve months if they are stored at 20°C. Use the charge method specified in "3. Preparation Prior to Use". The interval of this charge should be reduced to 50% by each 10°C rise in temperature above 20°C. The self-discharge rate doubles for each 10°C in temperature. If they are stored for a long time in a discharged state, their capacity may not recover even after charge. If the batteries are stored for more than a year at room temperature, the life of the batteries may be shortened.

(2) Store the batteries starting from the fully charged state to prevent the life of the batteries being shortened.

(3) Use the batteries as quickly as possible after receiving them as they gradually deteriorate even under proper storage conditions.

9. Disposal and Recycling

CAUTION

(1) Please write the information about battery recycling on the equipment, the package, the carton, the instruction manual etc. in countries where legal or voluntary regulations on battery recycling are applicable.

(2) Design the equipment such that exchange and disposal of the batteries can be undertaken easily.

(3) Used batteries should be recycled. When returning used batteries, insulate their terminals using adhesive tape, etc. Even used batteries still have electrical charge and an explosion or a fire may occur, if proper insulation is not given on the terminals of the used batteries.

2 | General Information

1. Battery Construction

Positive plates

Positive plates are plate electrodes of which a grid frame of lead-tin-calcium alloy holds porous lead dioxide as the active material. The magnification of a positive active material is shown on following figure (1).

Fig. 1 Magnification of positive active material

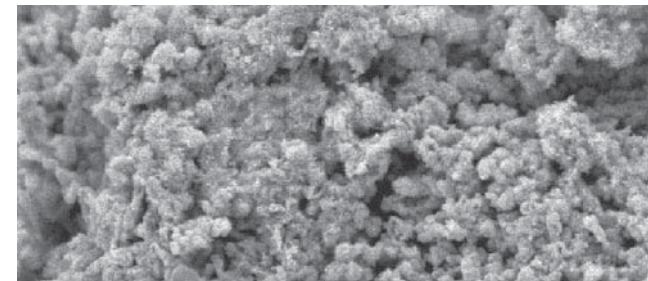

Negative plates

Negative plates are plate electrodes of which a grid frame of lead-tin-calcium alloy holds spongy lead as the active material. The magnification of a negative active material is shown on following figure (2).

Fig. 2 Magnification of negative active material

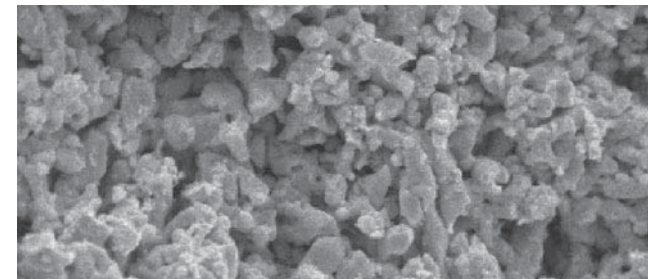

Electrolyte

Diluted sulfuric acid is used as the medium for conducting ions in the electrochemical reaction in the battery. Some additives are included to keep good recovery performance after deep discharge.

Separators

Separators, which retain electrolyte and prevent shorting between positive and negative plates, adopt a non-woven fabric of fine glass fibers which is chemically stable in the diluted sulfuric acid electrolyte. Being highly porous, separators retain electrolyte for the reaction of active materials

in the plates. Typical magnification of separator is shown in following figure (3).

Fig. 3 Typical magnification of separator

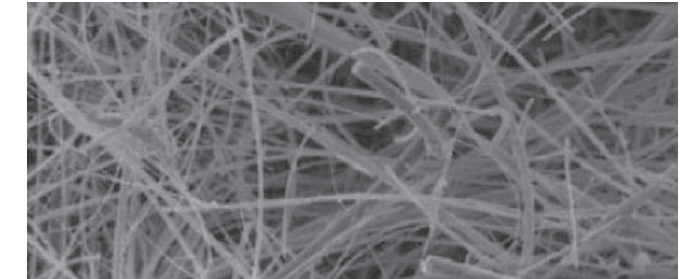

Vent (One way valve)

The valve is comprised of a one-way valve made of material such as neoprene. When gas is generated in the battery under extreme overcharge condition due to erroneous charging, charger malfunctions or other abnormalities, the vent valve opens to release excessive pressure in the battery and maintain the gas pressure within specific range (7.1 to 43.6 kPa). During ordinary use of the battery, the vent valve is closed to shut out outside air and prevent oxygen in the air from reacting with the active material in the negative electrodes.

Positive and negative electrode terminals

Positive and negative electrode terminals may be faston tab type, bolt fastening type or threaded post type, depending on the type of the battery. Sealing of the terminal is achieved by a structure which secures long adhesive-embedded paths and by the adoption of strong epoxy adhesives. For specific dimensions and shapes of terminals, see page 23.

Battery case materials and the design

Materials of the body and cover of the battery case are ABS resins, unless otherwise specified. Since the inside of VRLA battery is pressurized and depressurized, stress occurs at the container and cover. The design according to the stress is designed to accommodate the fluctuations in stress in the event the battery becomes deformed. The thickness of container, form, material and stress analysis are determined by utilization of computer aided engineering (CAE). This depicts the container design & strength. Destructive examinations using the molded container are also carried out. In other cases in which water in electrolysis liquid may penetrate through container in service life, the container design is put through

2 | General Information

water penetration tests.

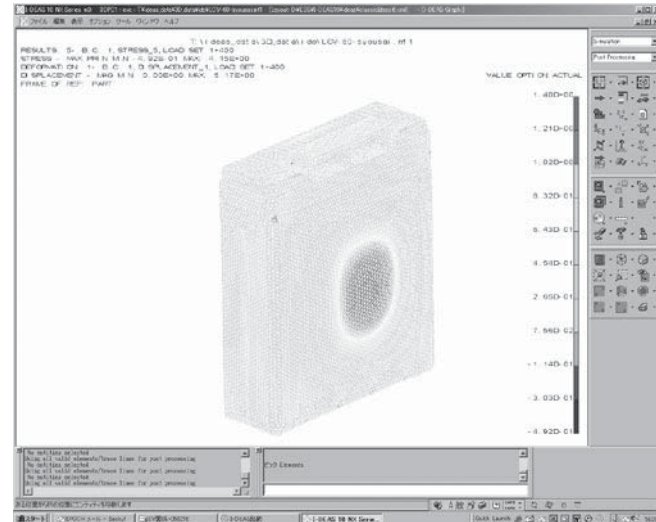

Battery case materials (example LC-R Series)

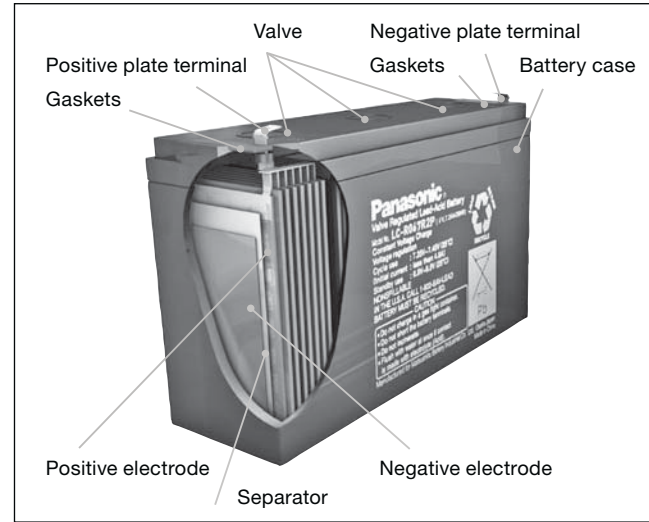

2. Electrochemical Reactions on Electrodes

The electrochemical reaction processes of the sealed lead-acid battery (negative electrode recombination type) are described below. Where “charge” is the operation of supplying the rechargeable battery with direct current from an external power source to change the active material in the negative

plates chemically, and hence to store in the battery electric energy in the form of chemical energy. “Discharge” is the operation of drawing out electric energy from the battery to operate external equipment.

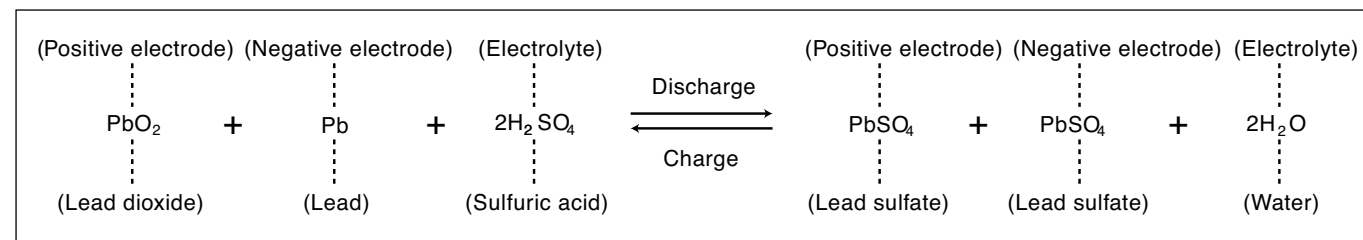

In the final stage of charging, an oxygen-generating reaction occurs at the positive plates. This oxygen transfers inside the battery, then is absorbed into the surface of the negative

plates and consumed. These electrochemical reaction processes are expressed as follows.

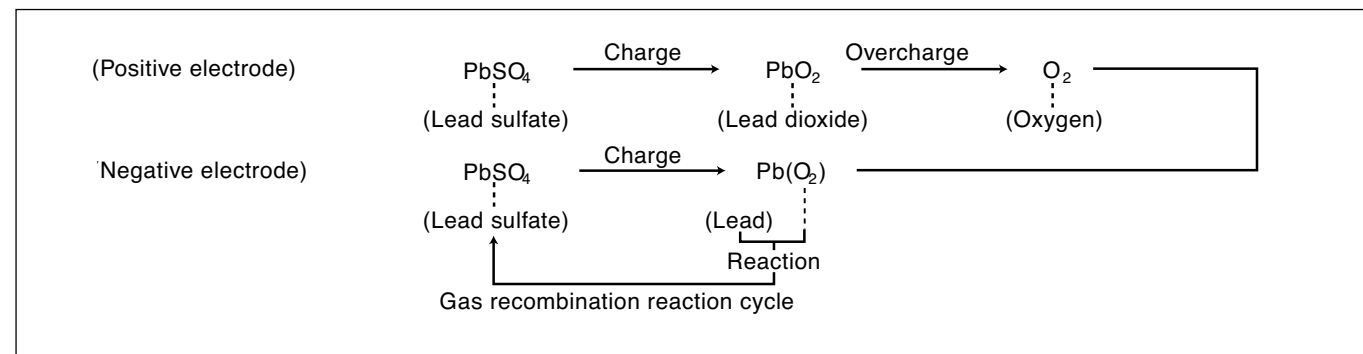

2 | General Information

3. Applications

Stand-by/Back-up power applications

- Communication equipment: base station, PBX, CATV, WLL, ONU, STB, etc.
- Back-up for power failure: UPS, ECR, computer system back-up, sequencers, etc.
- Energy saving: solar and/or wind powered lanterns, wind powered advertising displays etc.
- Emergency equipment: lights, fire and burglar alarms, radios, fire shutters, stop-position controls (for machines and elevators), etc.

Main power applications

- Electrically operated vehicles: picking carts, automated transports, electric wheelchairs, cleaning robots, electric automobiles, electric lawnmowers, etc.
- Tools and engine starters: grass shears, hedge trimmers, scouters, jet-skis, electric saws, etc.
- Industrial equipment/instruments and non life-critical medical equipment*: measuring equipment, non life-critical medical equipment (electrocardio-graph), etc.
- Photography: camera strobes, VTR/VCR, movie lights, etc.
- Toys and hobby: radio-controllers, motor drives, lights, etc.
- Miscellaneous uses: integrated VTR/VCR, tape recorders, other portable equipment, etc.

* (Note) When any medical equipment incorporating a Panasonic VRLA battery is planned, please contact Panasonic.

4. Features

Leak-resistant structure

A required-minimum quantity of electrolyte is impregnated into, and retained by, the positive and negative plates and the separators; therefore electrolyte does not flow freely. Also, the terminal has a sealed structure secured by long adhesive-embedded paths and by the adoption of strong epoxy adhesives which makes the battery leak-resistant. (Note) In stand-by/back-up uses, if the battery continues to be used beyond the point where discharge duration has decreased to 50% of the initial (i.e. life judgment criteria), cracking of the battery case may occur, resulting in leakage of the electrolyte.

Long service life

Service life of our long-life series (LC-P, LC-X series) is approximately double that of the conventional (LC-R and LC-L series) batteries (Temperature 20°C, discharge rate 0.25 CA/1.75V/cell, discharge frequency every 6 months, 2.30V/cell charge).

Easy maintenance

Unlike conventional batteries in which electrolyte can flow freely, VRLA batteries do not need the specific-gravity check of the electrolyte or the water top up maintenance, this allows the battery to function fully with the minimum of maintenance.

No sulfuric acid mist or gases

Unlike conventional batteries in which electrolyte can flow freely, VRLA batteries generate no Sulphuric acid mist or gases under Panasonic recommended use conditions. If used under conditions other than recommended then gas generation may occur, therefore do not design the battery housing in a closed structure.

Exceptional deep discharge recovery

Our VRLA batteries show exceptional rechargeability even after deep discharge, which is often caused by failure to turn off the equipment switch, followed by standing (approx. 1 month at room temperature is assumed).

3 | Characteristics

1. Charging

Charge characteristics (constant voltage-constant current charging) of VRLA batteries are exemplified below.

Example of constant-voltage charge characteristics by current

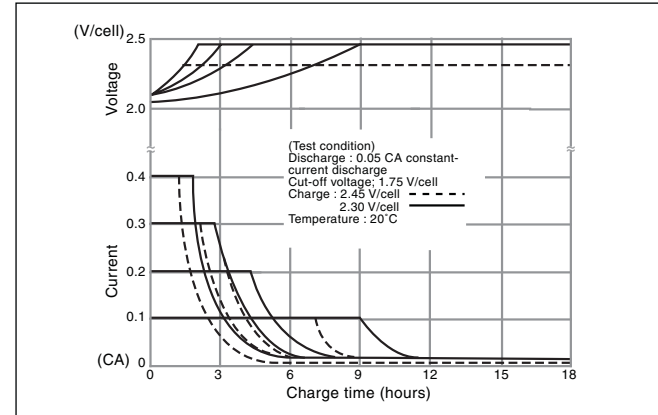

In order to fully utilize the characteristics of VRLA batteries, constant-voltage charging is recommended. For details of charging see pages 19 – 23.

2. Discharging

a) Discharge current and discharge cut-off voltage

Recommended cut-off voltages for 6V and 12V batteries consistent with discharge rates are given in the figure below. With smaller discharge currents, the active materials in the battery work effectively, therefore discharge cut-off voltages are set to the higher side for controlling overdischarge. For larger discharge currents, on the contrary, cut-off voltages are set to the lower side. (Note) Discharge cut-off voltages given are recommended values.

Discharge current vs. Cut-off voltage

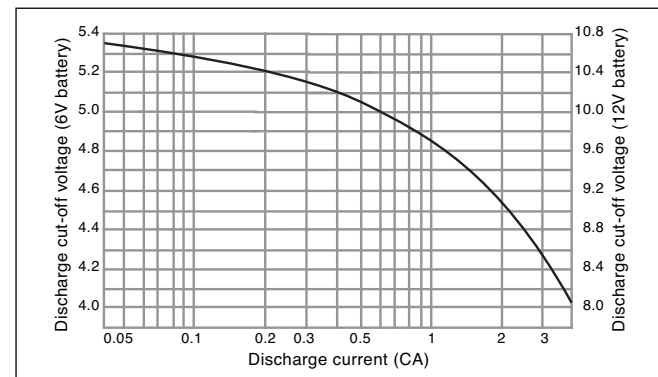

b) Discharge temperature

(1) Control the ambient temperature during discharge within the range from -15°C to 50°C for the reason described below.
 (2) Batteries operate on electrochemical reaction which converts chemical energy to electric energy. The electrochemical reaction is reduced as the temperature lowers, thus, available discharge capacity is greatly reduced at temperatures as low as -15°C. For the high temperature side, on the other hand, the discharge temperature should not exceed 50°C in order to prevent deformation of resin materials which house the battery or deterioration of service life.

c) Effect of temperature on discharge characteristics

Available discharge capacity of the battery varies with ambient temperature and discharge current as shown in the figure below.

Discharge capacity by temperature and by discharge current

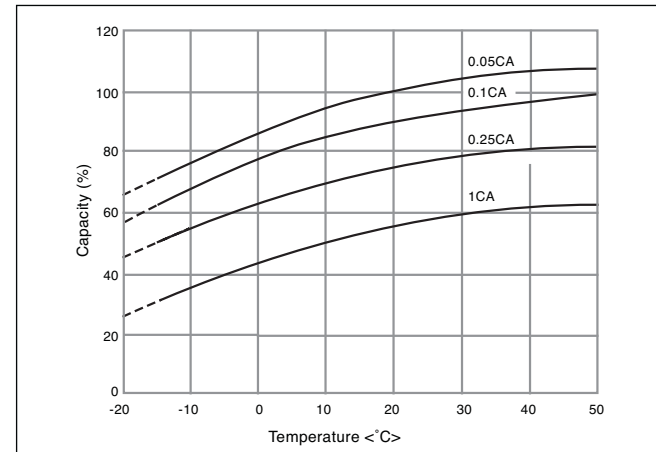

d) Discharge current

Discharge capability of batteries is expressed by the 20 hour rate (rated capacity). Select the battery for specific equipment so that the discharge current during use of the equipment falls within the range between 1/20 of the 20 hour rate value and 3 times that (1/20 CA to 3 CA): discharging beyond this range may result in a marked decrease of discharge capacity or reduction in the number of times of repeatable discharge. When discharging the battery beyond said range, please consult Panasonic in advance.

e) Depth of discharge

Depth of discharge is the state of discharge expressed by the ratio of amount of capacity discharged to the rated capacity.

3 | Characteristics

3. Storage

a) Storage condition

Observe the following condition when the battery needs to be stored.

- (1) Ambient temperature: -15°C to 40°C (preferably below 30°C)
- (2) Relative humidity: 25 to 85%
- (3) Storage place free from vibration, dust, direct sunlight, and moisture.

b) Self discharge and refresh charge

During storage, batteries gradually lose their capacity due to self discharge, therefore the capacity after storage is lower than the initial capacity. For the recovery of capacity, repeat charge/discharge several times for the battery in cycle use; for the battery in trickle use, continue charging the battery as loaded in the equipment for 48 to 72 hours.

c) Refresh charge (Auxiliary charge)

When it is unavoidable to store the battery for 3 months or longer, periodically recharge the battery at the intervals recommended in the table below depending on ambient temperature. Avoid storing the battery for more than 12 months.

Storage temperature	Interval of auxiliary charge (refresh charge)
Below 20°C	12 months
20°C to 30°C	9 months
20°C to 40°C	6 months

d) Residual capacity after storage

The result of testing the residual capacity of the battery which, after fully charged, has been left standing in the open-circuit state for a specific period at a specific ambient temperature is shown in the figure below. The self discharge rate is very much dependent on the ambient temperature of storage. The higher the ambient temperature, the less the residual capacity after storage for a specific period. Self discharge rate almost doubles by each 10°C rise of storage temperature (Figure 1).

e) Open circuit voltage vs. residual capacity

Residual capacity of the battery can be roughly estimated by measuring the open circuit voltage as shown in the figure (2).

Fig. 1 Residual capacity test result

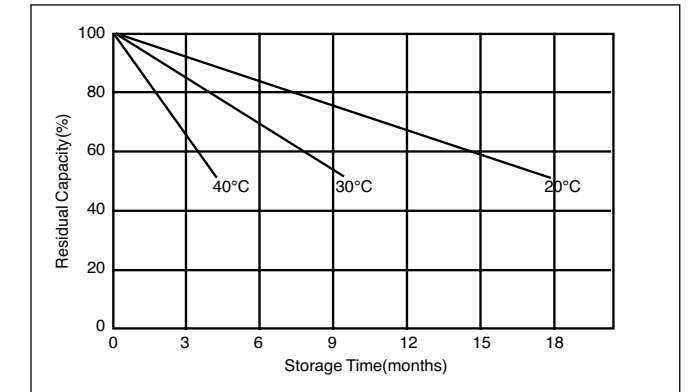
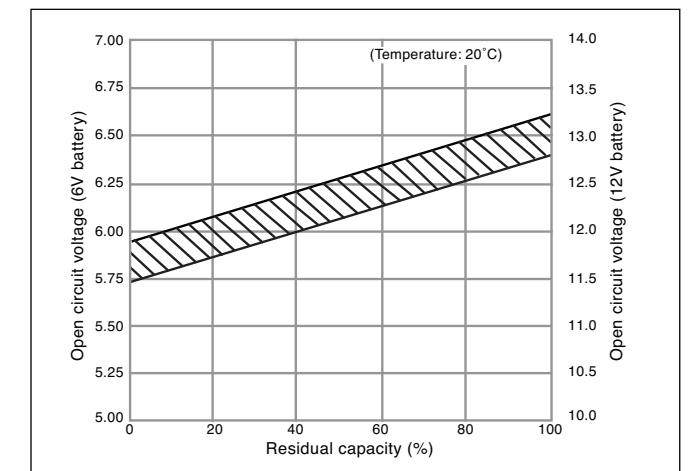
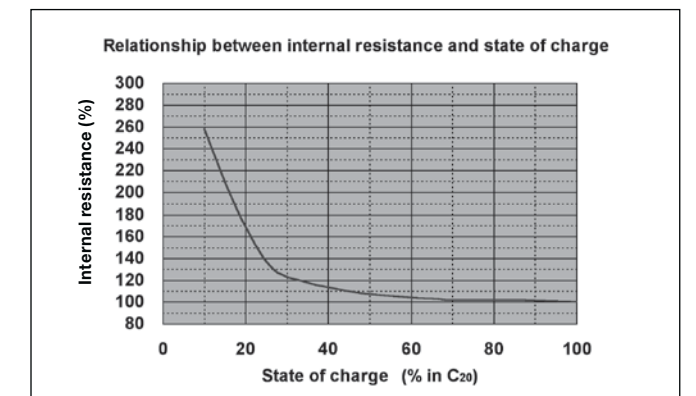

Fig. 2 Open circuit voltage vs. Residual capacity 20°C



4. Internal Resistance

The internal resistance is an important parameter of batteries. Internal resistance varies with the state of charge of the battery and temperature as shown on the chart below.



3 | Characteristics

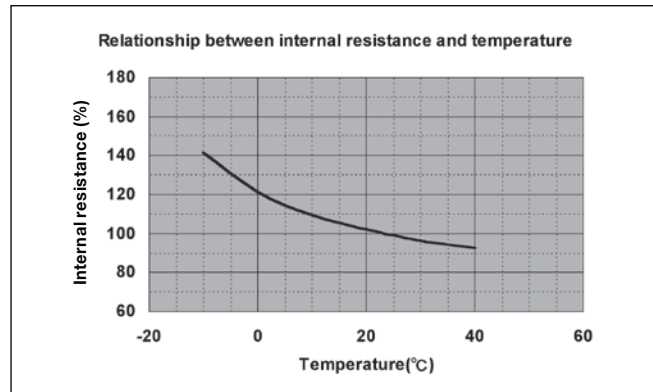

5. Temperature conditions

Recommended temperature ranges for charging, discharging and storing the battery are tabulated below.

Charge	0°C ~ 40°C
Discharge	-15°C ~ 50°C
Storage	-15°C ~ 40°C

6. Battery life

a) Cycle life

Cycle life (number of cycles) of the battery is dependent on the depth of discharge in each cycle. The deeper the discharge is, the shorter the cycle life (smaller number of cycles), providing the same discharge current. The cycle life (number of cycles) of the battery is also related to such factors as the type of the battery, charge method, ambient temperature, and rest period between charge and discharge. Typical cycle-life characteristics of the battery by different charge/discharge conditions are shown by the below figures. This data is typical and tested at a well-equipped laboratory. Cycle times are different for each battery model. Cycle times are also different from this data when using batteries under real conditions.

b) Trickle (Float) life

Trickle life of the battery is largely dependent on the temperature condition of the equipment in which the battery is used, and also related to the type of the battery, charge voltage and discharge current. The respective Figures show the influence of temperature on trickle life of the battery, an example of trickle (float) life characteristics of the battery, and the test result of the battery life in an emergency lamp.

Cycle life vs. Depth of discharge

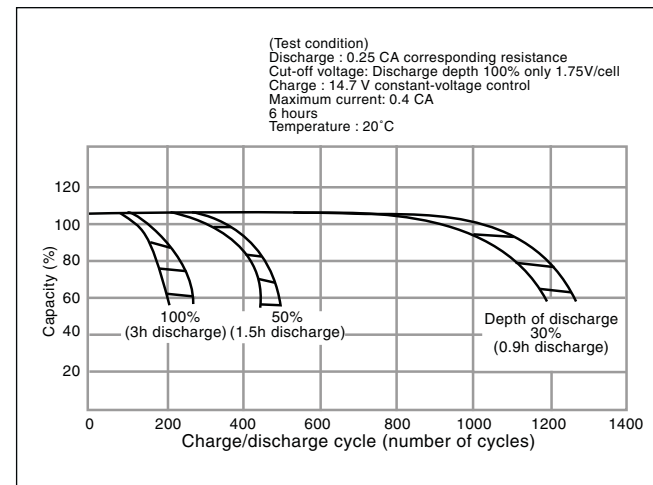

Influence of Temperature on Trickle life

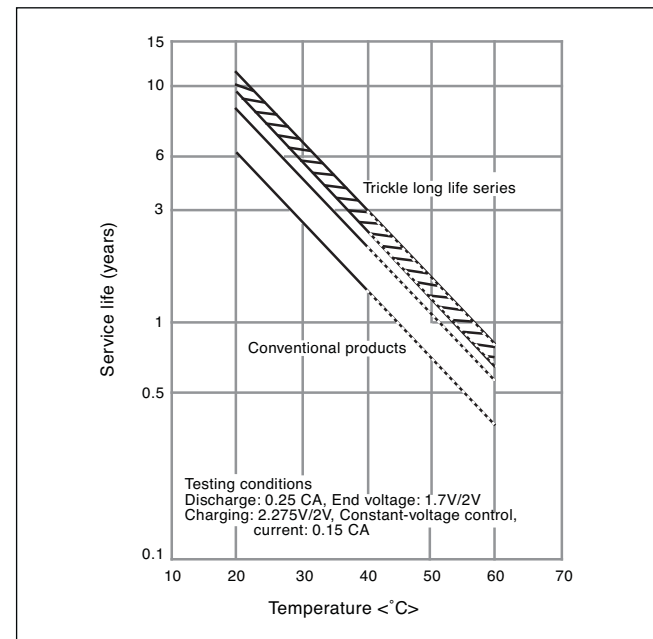

Trickle life characteristics at 50°C

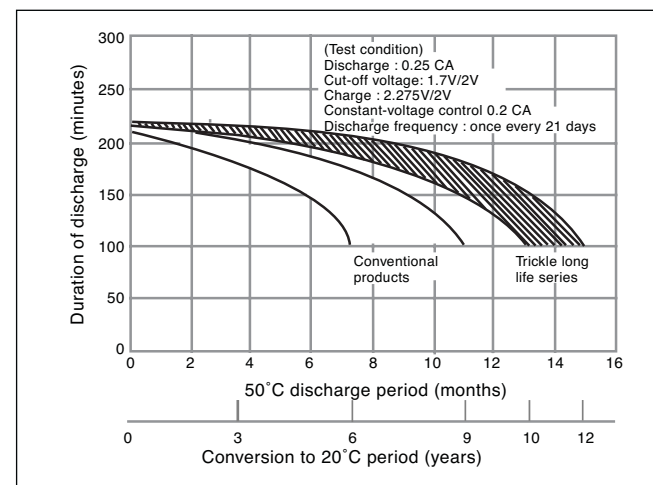

4 | Charging Methods

Methods of Charging the Valve Regulated Lead-Acid Battery

For charging the valve regulated lead-acid battery, a wellmatched charger should be used because the capacity and life of the battery is influenced by ambient temperature, charge voltage and other parameters. Charging methods are dependent on battery applications and are roughly classified into main power applications and stand-by/back-up power applications.

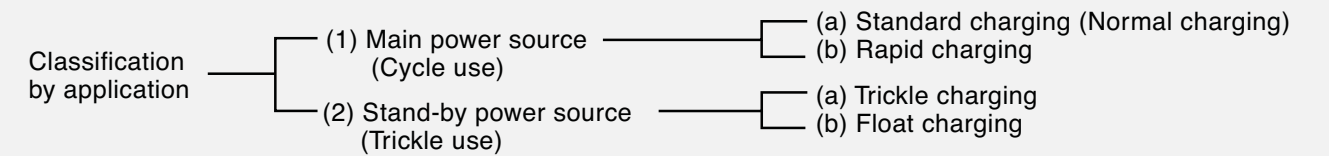

(1) Main Power cycle use

Cycle use is to use the battery by repeated charging and discharging.

(a) Standard charging (Normal charging)

For common applications of the battery, the constant voltage charge method is advantageous as it allows the battery to exert full performance.

• Constant voltage charging method

This method is to charge the battery by applying a constant voltage between the terminals. When the battery is charged by applying a voltage of 2.45 V per cell (unit battery) at a room temperature of 20°C to 25°C, charging is complete when the charge current continues to be stable for three hours. Valve regulated lead-acid batteries can be overcharged without constant voltage control. When the battery is overcharged, the water in the electrolyte is decomposed by electrolysis to generate more oxygen gas than what can be absorbed by the negative electrode. The electrolyte is changed to oxygen gas and hydrogen gas, and lost from the battery system. As the quantity of electrolyte is reduced, the chemical reactions of charge and discharge become inefficient and hence the battery performance is severely deteriorated. Therefore, exact voltage control and proper charging time in constant voltage charging are essential for securing the expected life of the battery.

• Constant voltage and constant-current charging method

This method is to charge the battery by controlling the current at 0.4 CA and controlling the voltage at 2.45 V / per cell at a room temperature of 20°C to 25°C. Proper charging time is 6 to 12 hours depending on depth of discharge.

Constant voltage constant-current charge characteristics

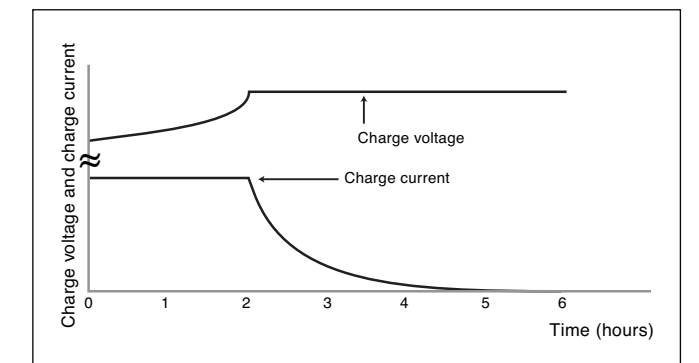

(b) Rapid charging

When rapidly charging the battery, a large charge current is required in a short time for replenishing the energy which has been discharged. Therefore, some adequate measures such as the control of charge current is required to prevent overcharging when the rapid charging is complete. Basic requirements for rapid charging are as follows:

- Sufficient charging should be made in a short time for fully replenishing the amount discharged.
 - Charge current should be automatically controlled to avoid overcharge even on prolonged charging.
 - The battery should be charged adequately in the ambient temperature range of 0°C to 40°C.
 - Reasonable cycle life of charge/discharge should be secured.
- Typical methods to control charging so as to satisfy the above requirements follow.

• Two-step constant voltage charge control method

Two-step constant voltage charge control method uses two constant-voltage devices. At the initial stage, the battery is charged by the first constantvoltage device SW(1) of high setup voltage (setup for cycle charge voltage). When the

4 | Charging Methods

charge current has reduced to the preset value, the device is switched over to the second SW(2) of low set-up voltage (setup for trickle charge voltage). This method has the advantage that the battery in trickle use can be charged in a comparatively short time for the next discharge.

Charging characteristics of the two-step constant voltage control charger

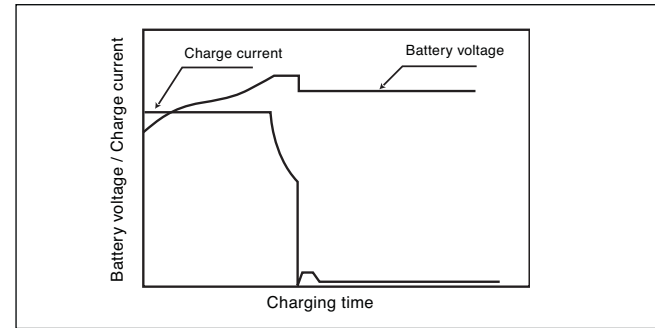

Block diagram of the two-step constant voltage control charger

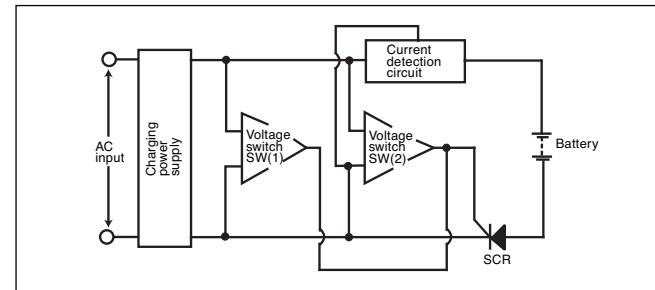

(2) Stand-by/Back-up use (Trickle use)

The application load is supplied with power from AC sources in normal state. Stand-by/back-up use is to maintain the battery system at all times so that it can supply power to the load in case the AC input is disrupted (such as a power failure). There are two methods of charging for this use.

(a) Trickle charge (Compensating charge)

Trickle charge

In this charge system, the battery is disconnected from the load and kept charged with a small current only for compensating self discharge while AC power is alive. In case of power failure, the battery is automatically connected to the load and battery power is supplied. This system is applied mainly as a spare power source for emergency equipment. In this use, if rapid recovery of the battery after discharge is required, it is necessary to consider the recovery charge with a comparatively large current followed by trickle charge, or alternative measures. While the type and capacity of the battery is de-

termined by the back-up time and the load (current consumption) during power failure, some reserve power should be taken into account considering such factors as ambient temperature, capability of the charger and depth of discharge.

Trickle charge system model

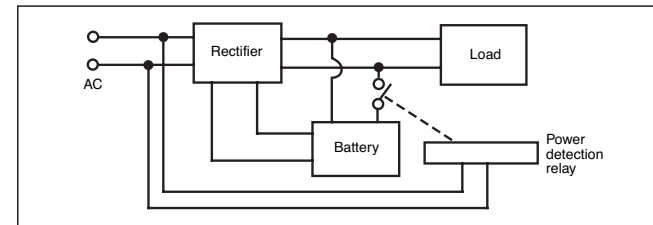

(b) Float charge

Float system is the system in which the battery and the load are connected in parallel to the rectifier, which should supply a constant power.

Float charge system model

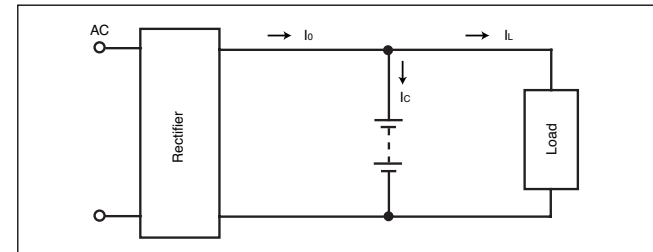

In the above-illustrated model, output current of the rectifier is expressed as: $I_o = I_c + I_L$ where I_c is charge current and I_L is load current. Consideration should be given to secure adequate charging because, in fact, load current is not constant but irregular in most cases.

In the float system, capacity of the constant-voltage power source should be more than sufficient against the load. Usually, the rectifier capacity is set at the sum of the normal load current plus the current needed in order to charge the battery.

(Precautions on charging)

- As the battery continues to be charged over a long period, a small difference in charging voltage may result in a significant difference in the battery life. Therefore, charge voltage should be controlled within a narrow range and with little variation for a long period.
- As charge characteristics of the battery are dependent on temperature, compensation for temperature variation is required when the battery is used over a broad temperature range, and the system should be designed so that the battery and the charger are kept at the same temperature.

4 | Charging Methods

Charging Methods and Applications of VRLA-Batteries

Application/Charging Method	Normal charging in 6 or more hours; Constant voltage control	Two-step constant voltage control	Constant Current Control
Cycle Use	Control voltage: 7.25 to 7.45V / 6V battery 14.5 to 14.9V / 12V battery Initial current: 0.4 CA or smaller		
Trickle Use	Control voltage: 6.8 to 6.9 / 6V battery 13.6 to 13.8V / 12V battery	Initial charging with current of approx. 0.15 CA, followed by switching voltage to trickle charge	
Float Use	Control voltage: 6.8 to 6.9/6V battery; 13.6 to 13.8V / 12V battery. Float charging compensates for load fluctuations.		
Refresh charge (Auxiliary charge)*	When charging two or more batteries at a time, select only those which have been left under the same condition.		Charging with current of approx. 0.1 CA
Application example	General uses, Cellular phones (bag phones), UPS, Lanterns, Electric tools	Medical equipment, Personal radios	

Note * Refresh (auxiliary) charge amount should be 120 to 130% of self-discharge amount. For details, please contact us.

(Precautions on charging)

- (a) in constant voltage charging (cycle use): Initial current should be 0.4 CA or smaller (C: rated capacity)
(b) in constant voltage charging (trickle use): Initial current should be 0.15 CA or smaller (C: rated capacity)
- Relation between standard voltage value in constant voltage charging and temperature is given in the Table.

Relation between standard voltage value in constant voltage charging and temperature

		0°C	20°C	40°C
Cycle use	6V	7.7	7.4	7.1
	12V	15.4	14.7	14.2
Trickle use	6V	7.1	6.8	6.7
	12V	14.1	13.7	13.4

a) Temperature compensation of charge voltage

Charge voltage should be compensated to the ambient temperature near the battery, as shown by the figure below. Main reasons for the temperature compensation of charge voltage are to prevent the thermal runaway of the battery when it is used in high temperature conditions and to secure sufficient charging of the battery when it is used in low temperature conditions. Prolongation of service life of the battery by the above-described temperature compensation is expected as follows

- At 30°C: prolonged by approx. 5%
- At 35°C: prolonged by approx. 10%
- At 40°C: prolonged by approx. 15%

In low temperature zones below 20°C, no substantial prolongation of the battery life can be expected by the temperature compensation of charge voltage.

Compensated voltage value

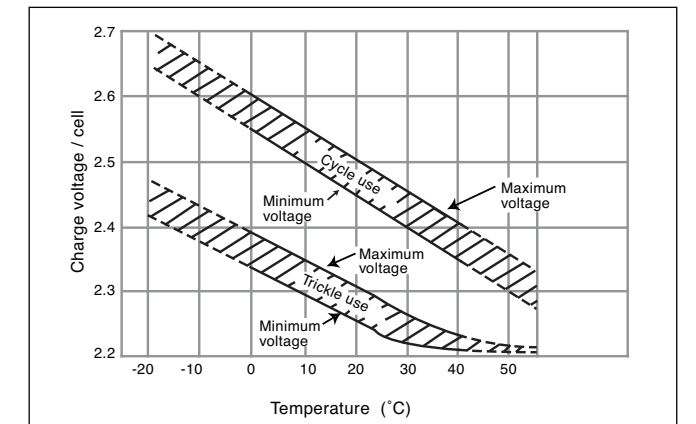

b) Charging time

Time required to complete charging depends on factors such as depth of discharge of the battery, characteristics of the charger and ambient temperature. For cycle charge, charging time can be estimated as follows:

- when charge current is 0.25 CA or greater:

$$T_{ch} = C_{dis} / I + (3h \text{ to } 5h)$$

- when charge current is below 0.25 CA:

$$T_{ch} = C_{dis} / I + (6h \text{ to } 10h), \text{ where}$$

T_{ch} : Charging time required (hours),

C_{dis} : Amount of discharge before this charging (Ah)

I : Initial charge current (A)

Time required for trickle charge ranges from 24 to 48 hours.

4 | Charging Methods

c) Charging temperature

- (1) Charge the battery at an ambient temperature in the range from 0°C to 40°C.
- (2) Optimum temperature range for charging is 5°C to 35°C.
- (3) Charging at 0°C or below and 40°C or higher is not recommended: at low temperatures, the battery may not be charged adequately; at high temperatures, the battery may become deformed.
- (4) For temperature compensation values, see a).

d) Reverse charging

Never charge the battery in reverse, as it may cause leakage, heating or bursting of the battery.

e) Overcharging

Overcharge is an additional charge after the battery is fully charged. Continued overcharging shortens the battery life. Select a charge method which is specified or approved for each application.

f) Charging before use

Recharge the battery before use to compensate for capacity loss due to self-discharge during storage. (See "Refresh charge" (auxiliary charge) table on page 15.)

Characteristics of constant voltage chargers

Even with the same voltage set-up, charging time varies with output V-I characteristics.

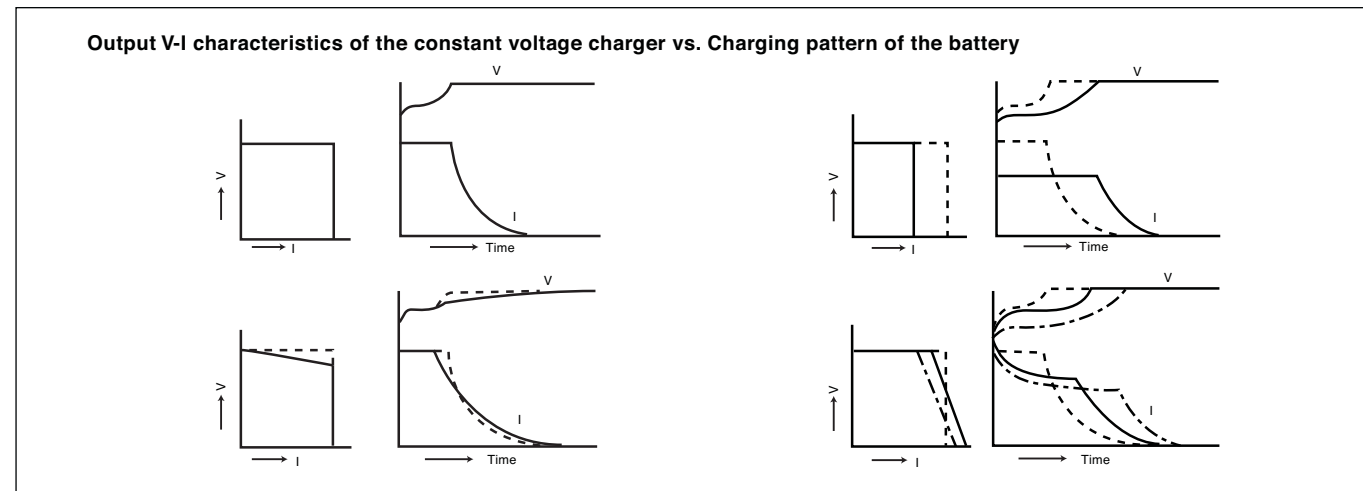

Constant voltage charger circuitry (Concept diagram)

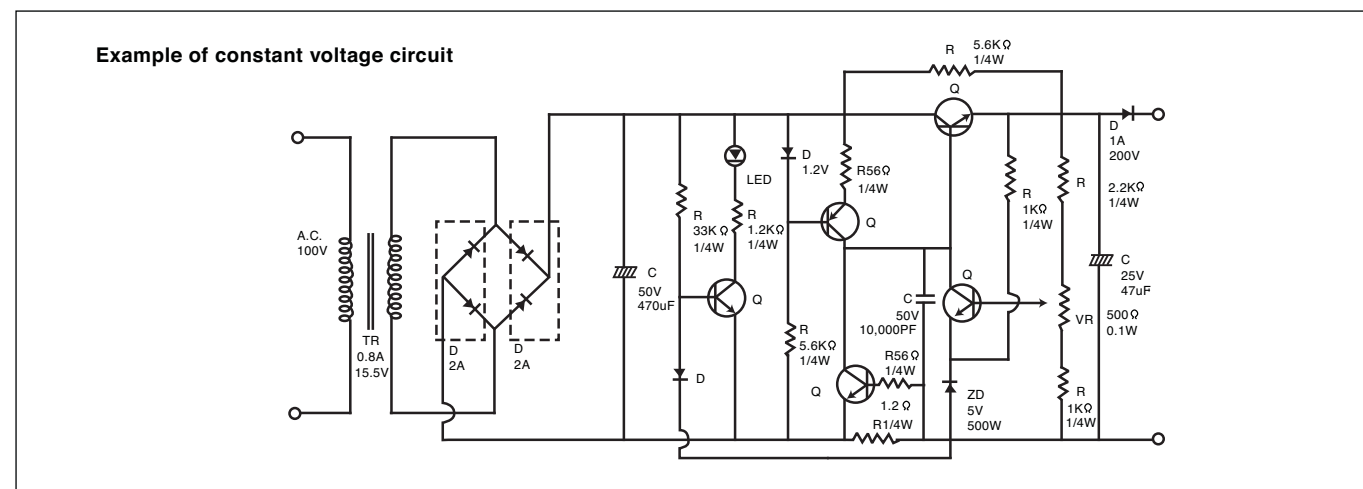

4 | Charging Methods

Precautions

- 1) When adopting charging methods and charging conditions other than those described in the specifications or the brochures, thoroughly check charging/discharging characteristics and life characteristics of the battery in advance. Selection of appropriate methods and conditions of charging is essential for safe use of the battery and for fully utilizing its discharge characteristics.
- 2) In cyclic use of the battery, use a charger equipped with a charging timer or a charger in which charging time or charge amount is controlled by other means; otherwise, it will be difficult to judge the completion of the charge. Use of a charger as described above is recommended to prevent undercharge or overcharge which may cause deterioration of the battery characteristics.

- 3) Continue charging the battery for the specified time or until the charge completion lamp, if equipped, indicates completion of charging. Interruption of charging may cause a shortening of service life.
- 4) Do not recharge the fully charged battery repeatedly, as overcharge may accelerate deterioration of the battery.
- 5) In cyclic use of the battery, do not continue charging for 24 hours or longer, as it may accelerate deterioration of the battery.
- 6) In cyclic service of the battery, avoid charging two or more batteries connected in parallel simultaneously: imbalance of charge/discharge amount among the batteries may shorten the life of batteries.

5 | Terminal Data

1. Bold and Nut type

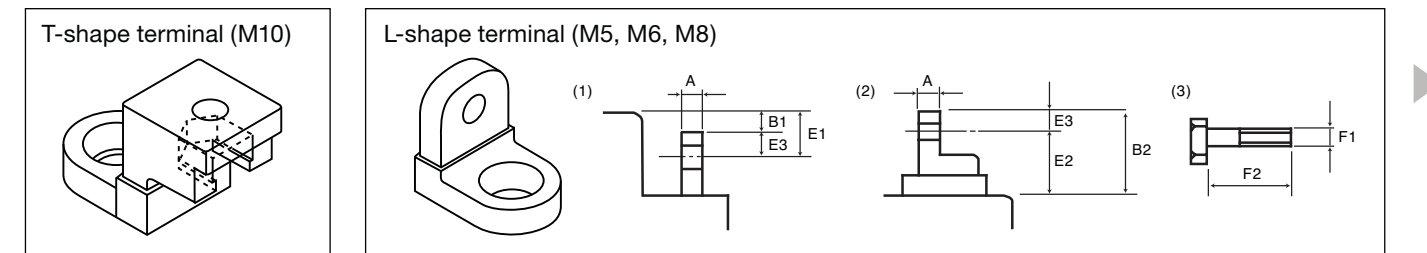

Type of Terminal	Terminal thickness A (1)	Height from battery case top		Terminal width	Hole diameter	Hole Position			Bolt		
		B1 (1)	B2 (2)			Distance from top: E1 (1)	Distance from top: E2 (2)	Distance from terminal top: E3 (2)	Diameter F1 (3)	Pitch	Length F2 (3)
M5 bolt and nut	5.0 ± 0.3	1.0	-	11 ± 0.4	5.5 ± 0.3	6.5	-	5.5 ± 0.3	M5	P = 0.8	15 ± 1.0
M6 bolt and nut	8.0 ± 0.5	5.0	16.5 ± 1.5	16 ± 0.8	6.5 ± 0.4	-	9 ± 1.0	7.5 ± 0.4	M6	P = 1.0	20 ± 1.0
M8 bolt and nut	8.0 ± 0.5	-	24 ± 1.5	-	6.5 ± 0.4	-	14 ± 1.0	10 ± 0.4	M8	P = 1.25	20 ± 1.0

2. Faston tab type

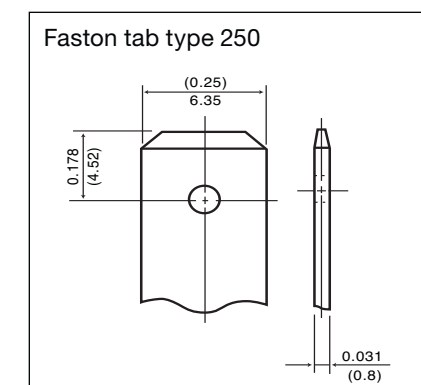
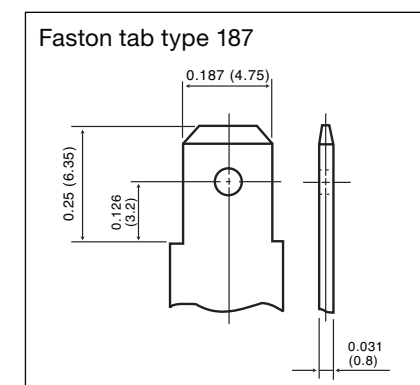

3. Threaded post type

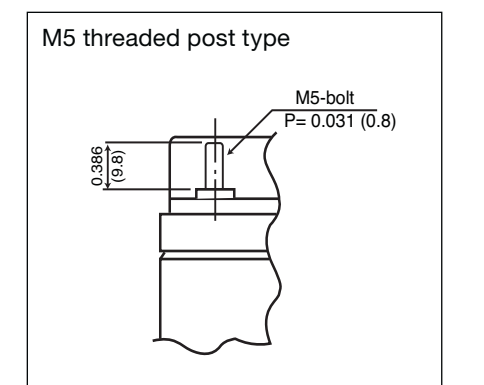

6 | Safety

VRLA battery safety test items

Item	Test method	Check point
1. Shock test (Drop test) IEC 61056-1 and JIS C 8702 (These specifications are harmonized each other)	A fully charged battery is allowed to drop in the upright position from the height of 20 cm onto a hard board having a thickness of 10 mm or more. Test is repeated three times.	The battery should be free from noticeable breakage or leaks; and its terminal voltage should be held higher than the nominal voltage.
2. Vibration test IEC 61056-1 and JIS C 8702 (These specifications are harmonized each other)	A vibration frequency 1000 times/minute and amplitude 4 mm is applied to the X-, Y- and Z-axis directions of a fully charged battery for 60 minutes respectively.	No battery part should be broken; the battery should be free from leaks; and its terminal voltage should be held higher than the nominal voltage.
3. Oven test Panasonic internal standard	A fully charged battery is left standing in an atmosphere of 70°C for 10 hours.	The battery case should not be deformed; the battery should be free from leaks.
4. Coldproof test Panasonic internal standard	A fully charged battery is connected to a resistor equivalent to 60 hour rate discharge and left for 4 days; then the battery is left standing in an atmosphere of -30°C for 24 hours.	No crack should develop in the battery case; the battery should be free from leaks.
5. Heat cycle test Panasonic internal standard	A fully charged battery is exposed to 10 cycles of 2 hours at -40°C and 2 hours at 65°C.	No crack should develop in the battery case; the battery should be free from leaks.
6. Short circuit test Panasonic internal standard	A fully charged battery connected with a small resistor of 10 ohms or less is allowed to discharge.	The battery must not burn nor bust.
7. Large current discharge test Panasonic internal standard	A fully charged battery is allowed to discharge at 3CA to 4.8V / 6V battery level. (This test is not applicable to batteries having built-in thermostat.)	The battery should not burn or bust, and it should be free from battery case deformation, leaks and any irregularity internal connections.
8. Vent valve function test UL1998	A fully charged battery is submerged in liquid paraffin in a container, then overcharged at 0.4CA. (UL1989)	Release of gas from the vent should be observed.
9. Overcharge test Panasonic internal standard	A fully charged battery is overcharged at 0.1CA for 48 hours, left standing for one hour, and allowed to discharge at 0.05CA to 5.25V / 6V.	No irregularity should be noticed in the battery appearance; the battery should retain 95% or more of the initial capacity.

(Note) The above safety notes apply only to standalone batteries, not to embedded batteries.

7 | Safety Design

Vent (One way valve)

If the internal pressure of the battery is raised to an abnormal level, the rubber one way valve opens to release excessive pressure; thus the valve protects the battery from danger of bursting. Since the rubber valve is instantly resealable, the valve can perform its function repeatedly whenever required.

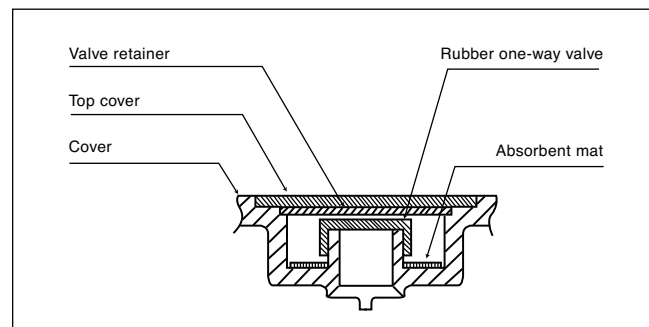

Example of Valve Construction

7 | Safety Design

VRLA batteries are inherently safe. However, there are some risks when VRLAs are used beyond a reasonable replacement time span, misapplied or abused. There are two main failure mode of VRLA battery used for trickle (float) application. In high temperatures and/or high voltage charging, dry-out is accelerated. This leads to loss of capacity and eventually the cell will fail open. Grid growth due to grid corrosion causes loss in mechanical strength and eventually leads to loss of contact with the grid. Battery should be replaced before these failures. If VRLA batteries are used after the end of life, the grid growth may cause a crack of container. Capillary action can result in a slight film of conductive electrolyte forming around the crack even though VRLA batteries contain significantly lower volumes of electrolyte and the electrolyte is immobilized. This electrolyte film will be in contact with an un-insulated metal component and this ground fault current could result in thermal runaway of a portion of the string or even a fire. And the grid growth may cause internal short between positive grid and negative strap in a cell. Continuing to charge a string of cells when one or more of the cells exhibit internal shorts, can result in thermal runaway. For example, assume a string of 12 cells is being charged at 27.3V (2.275V/cell) and the string continues in operation with two cells shorted. In this situation the average charging voltage on the remaining 10 good cells is 2.73V/cell. This will result in very high float current and cause thermal runaway.

Figure 1 is the mechanism of above phenomena.

Panasonic VRLA battery minimizes these risks by using less corrosive lead alloy and expanded positive grid. Figure 2 shows an example of cast grid and expanded grid. Expanded grid does not have enough strength to crack container case by grid growth. And an insulator between positive grid and negative strap is installed in the models as necessary.

Furthermore, Panasonic uses flame retardant battery container case for the models used for stand-by application. The cases are designed to be self-extinguishing and meet minimum flammability standards of UL94 V-0 and 28 L.O.I. (limiting oxygen index).

Figure 3 is the picture of self-extinguishing phenomenon.

Fig. 1 Mechanism of thermal runaway caused by grid growth

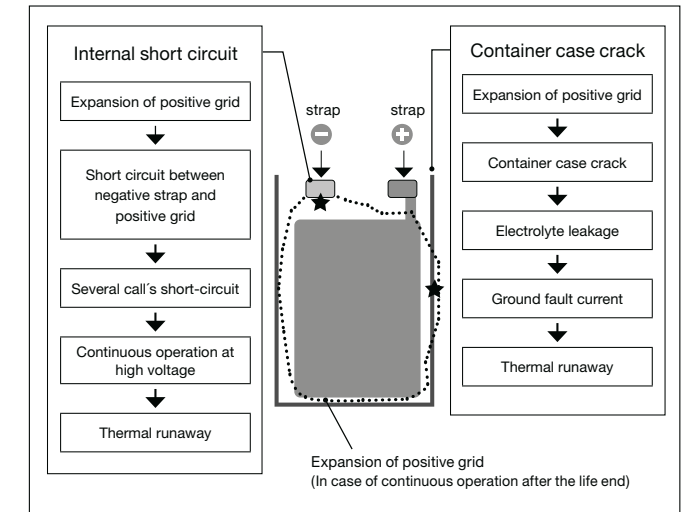

Fig. 2 Cast grid and expanded grid

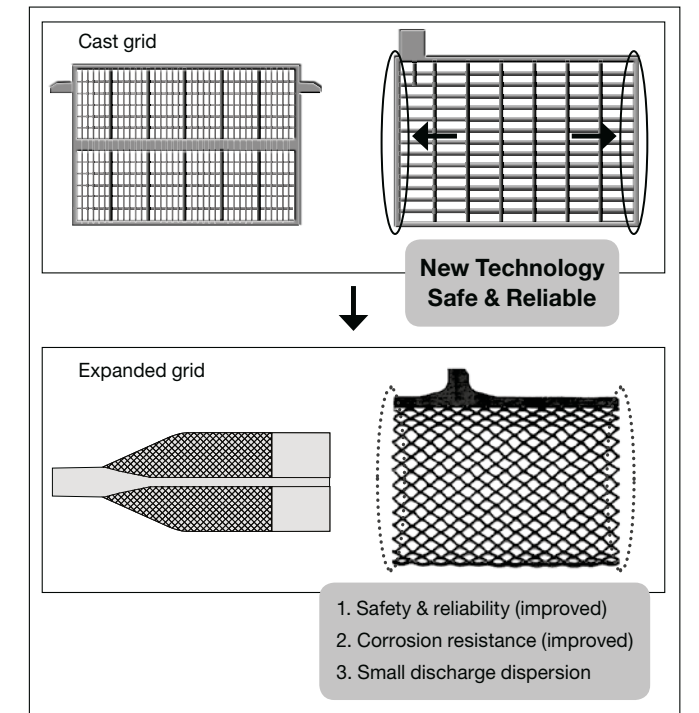
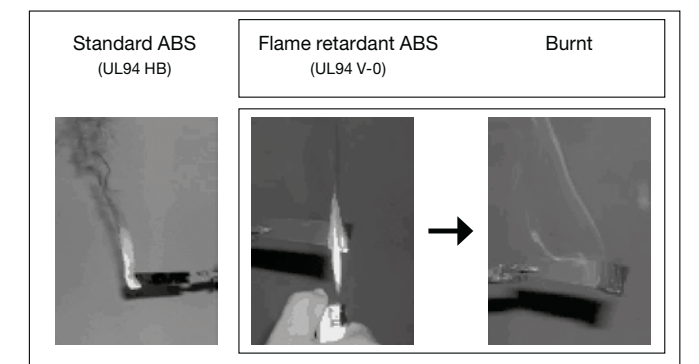

Fig. 3 Flame retardant case (Self-extinguish phenomenon)



8 | Model Numbers of VRLA-Batteries

Composition of Model Numbers

Figure No.	1	2	3	4	5	6	7	8	9	10	11	12
Model No.	L	C	-	⊗	⊗	⊗	⊗	⊗	⊗	⊗	⊗	⊗

⊗ Corresponding model number descriptions are listed below.
Please refer to the battery indexes for listings of available models.

No. 1 to 3

Product division codes (all of which are assigned by Panasonic). "LC" means Panasonic Valve Regulated Lead-Acid batteries.

No. 4

Fixed single-figure code (alphabetic letter) indicating properties, shape, etc. of the battery

- XC: Cycle long life products**
- X: Trickle long life products**
- P: Products combining trickle long life and flameretardant battery case**
- R: Small-sized common products (Under 17Ah)**
- V: Products of "R" and "L" types with flameretardant battery case (option)**

No. 5

Single code (alphabetic letter) for dividing products of the same type and the same capacity but having different shapes. (This figure may be omitted when not applicable, then the proceeding codes are advanced.)

Examples: LC-RD LC-XB

No. 5 to 7

Double-figure fixed codes indicating nominal voltage by numerical value.

Examples: 6V = 06, 12V = 12, etc.

No. 7 to 10

One- through four-figure (maximum) codes indicating capacity by numbers: decimal point is expressed by R (When some codes are not applicable, the proceeding codes are advanced.)

Examples:				
Capacity (20 hour rate)	4Ah	7.2Ah	12Ah	100Ah
	↓	↓	↓	↓
Model Number	4	7R2	12	100

No. 8 to 12

One- through five-figure (maximum) alphanumeric code for classifying products by terminal type, package form, destination code, etc.

Examples: P: English label
J: Japanese label
G: VdS certified products

(Note) 1) Country codes are subject to change.

8 | Model Numbers of VRLA-Batteries

Composition of Model Numbers

UP-RW series (High power batteries for UPS)

Figure No.	1	2	3	4	5	6	7	8	9	10	11	12
Model No.	U	P	-	*	W	□	□	◇	◇	◇	◇	◇

No. 1 to 3

Production division codes of high power batteries for UPS.

No. 4

Alphanumeric code indicates properties, shape, etc. of the battery.

R: Back-up power sources series.

No. 5

Indication of wattage.

No. 6

Single alphabetic letter for dividing products of the same type and the same capacity but having different shapes. (This figure may be omitted when not applicable, then the proceeding codes are advanced.)

Examples: UP-RW, UP-RWA

No. 6 to 8

Double-figure fixed codes indicating nominal voltage by numerical value.

Examples: 12V = 12, 24V = 24

No. 8 to 10

Indicating wattage at 2V, 10 minute rate discharge.

No. 10 to 12

One-through five-figure (maximum) alphanumeric code for classifying products by terminal type, package form, destination code, etc.

Examples: J: Japanese label
P: English label
1: Faston 250

(Note) The last numbers of model number changes depending on the country of destination. Please consult Panasonic for more details. Division codes are subject to change.

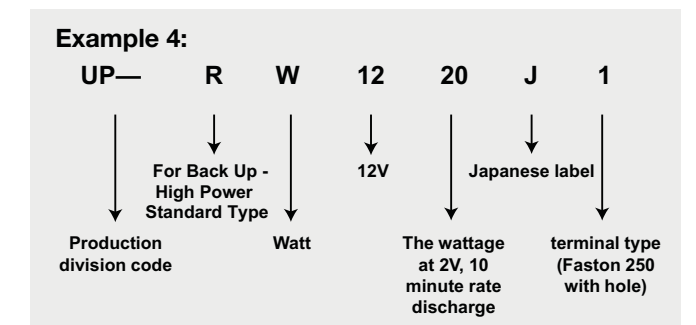
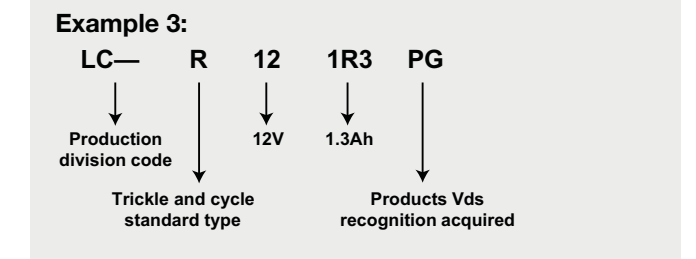
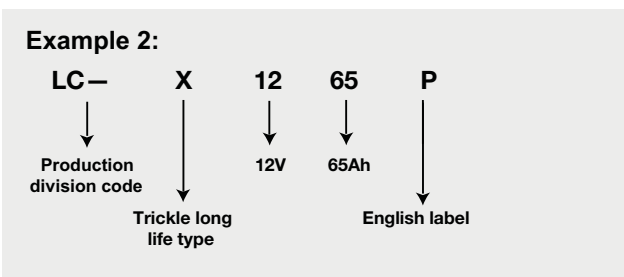
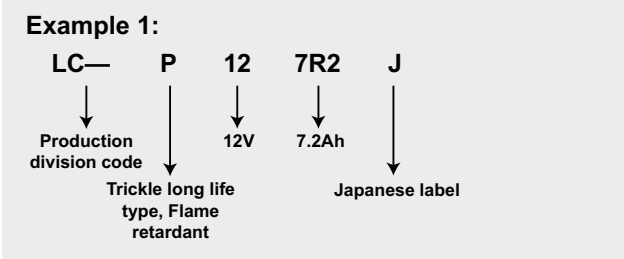

9 | Battery Selection Chart

Method of battery selection (Estimation of initial discharge time)

- (1) Determine discharge current.
- (2) Determine duration of discharge required.
- (3) Select batteries from the selection chart below. Then, select a battery which meets the specification of the equipment in which the battery is loaded such as voltage, dimensions and mass, from the "Battery Index" on page 28 to 29.

(4) Example

- Use condition: 2.9 A, 1.5 hours, 12 V; space allowable 100 mm x 160 mm x 105 mm
- 7.2 Ah is selected in the step (3).
- LC-R127R2P 94 mm x 151 mm x 100 mm is selected in the step (4).

(5) Refer to individual data sheets for detailed discharge characteristics of the battery.

(Note) Data given are the average values obtained within three cycles of charge/discharge, not the minimum values.

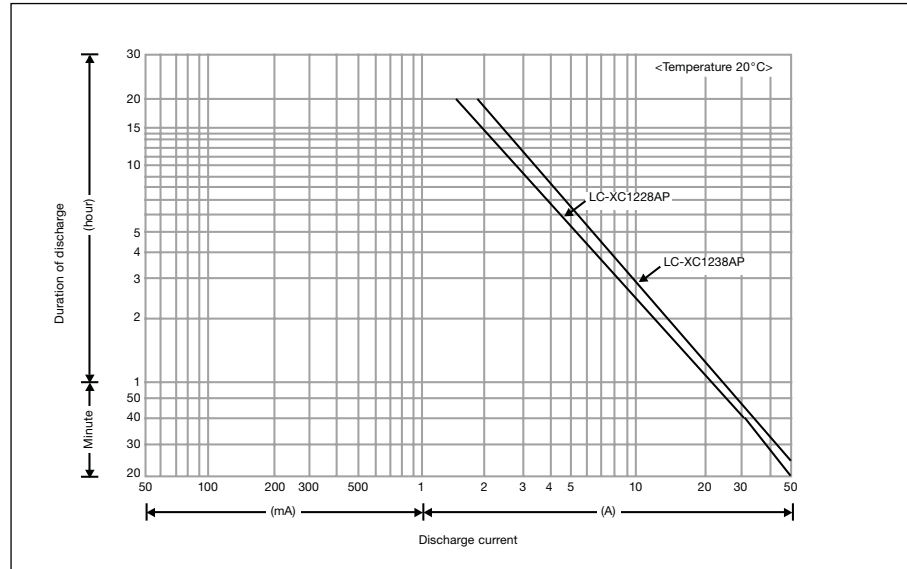

VRLA battery for main power applications

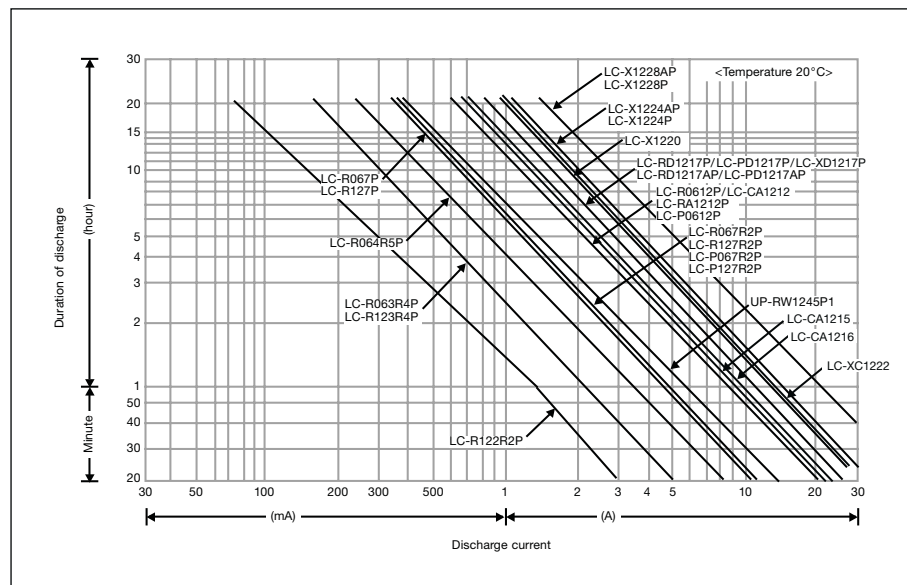

VRLA battery for standby power applications (2.2 Ah to 28 Ah)

9 | Battery Selection Chart

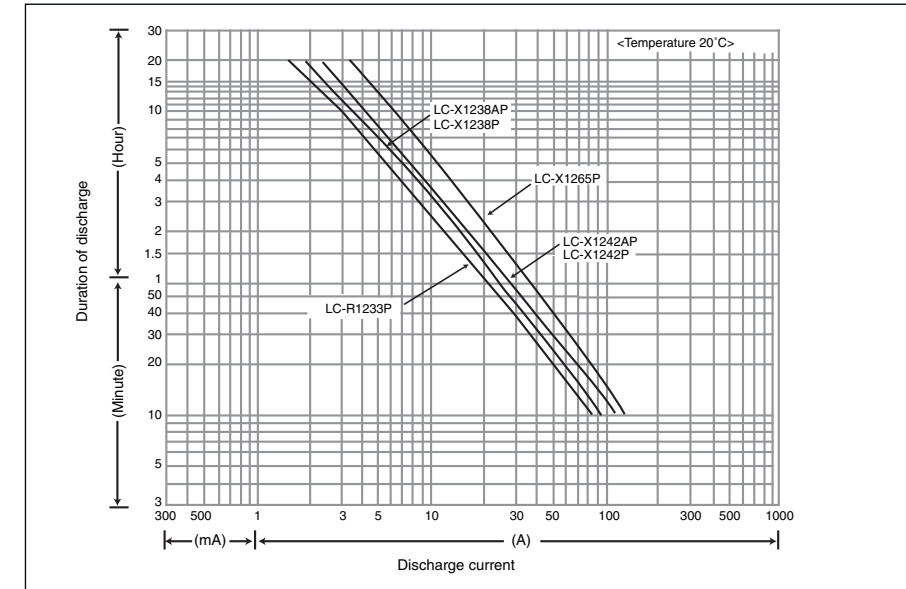

VRLA battery for standby power applications (33Ah to 65Ah)

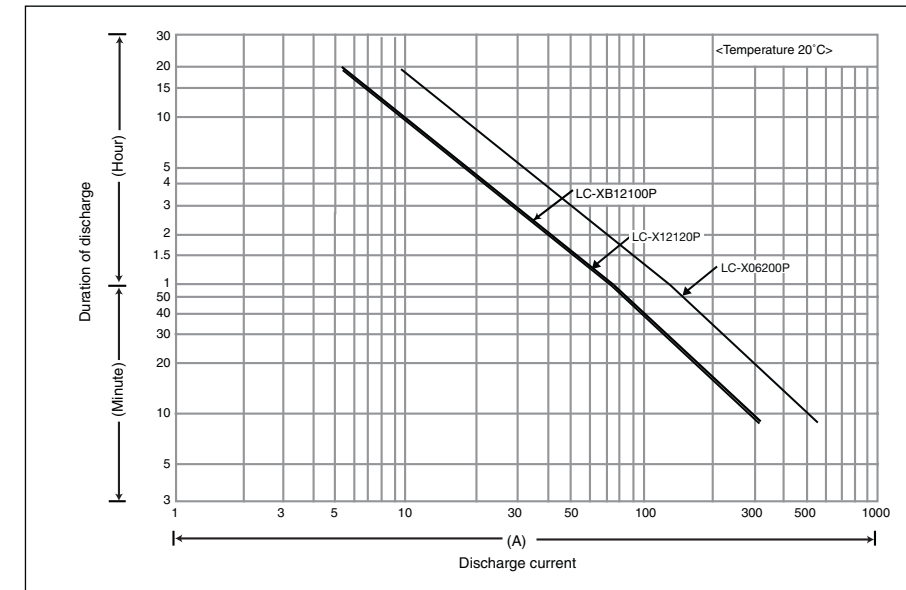

VRLA battery for standby power applications (100Ah)

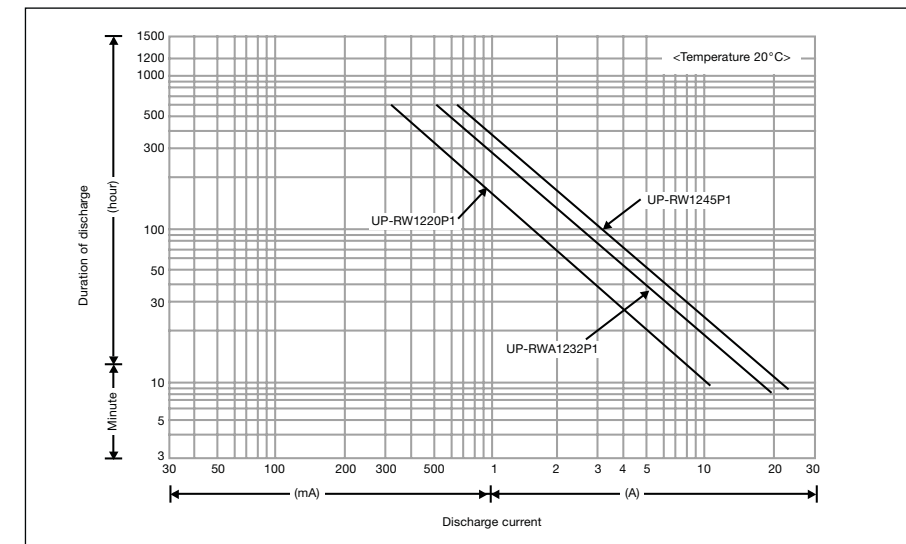

VRLA battery for standby power applications (high-power for UPS)

10 | Battery Selection Guide

Steps for selecting batteries are described below.

Study of required specifications (draft)

Study the required specifications (draft) by checking the requirements for the battery with the battery selection criteria. Technical requirements for selecting the battery are presented below.

Battery selection

First, select several candidate batteries by referring to the technical brochures and data sheets of the batteries presently available. Then from the candidates select a battery which can meet as many of the ideal requirements as possible. In fact, however, battery selection can be seldom made so smoothly. Practically, possible removal or easing of the requirements should be considered first; then depending on the result, a proper battery should be selected from those presently available. This way of proceeding

enables economic selection of the battery. Any questions at this stage should be asked to battery engineers in depth. Sometimes, new or improved batteries which are not carried in the brochures have become available, and an appropriate battery may be found among them. Usually, required specifications are finalized at this stage.

Request for improving or developing batteries

If no battery which will satisfy special requirements can be found by the above-described approach, requests for improving or developing new batteries should be made to our technical department, and these requests should be coordinated as quickly as possible to allow enough time for studying: the study takes usually 6 to 12 months or even longer depending on the request. In this section, guidelines for selecting appropriate batteries for specific equipment were mentioned. If further information regarding the battery selection is required, please contact us.

Technical requirements for battery selection

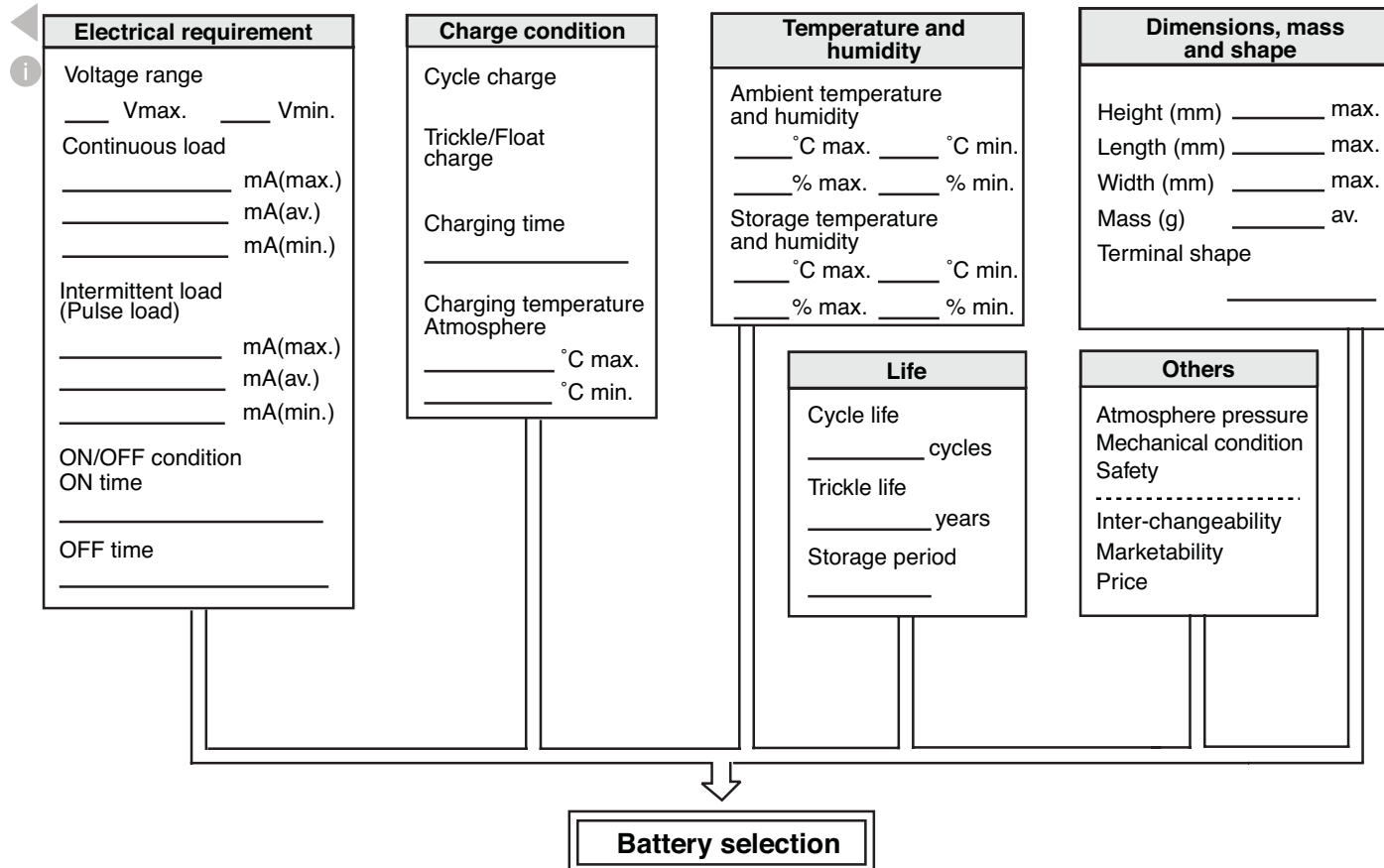

11 | Battery Index

Battery Types and Model Numbers

Application	Series	Trickle Design Life (at 20°C)	Category	Standard ABS (UL94 HB)	FR ABS = Flame Retardant ABS (UL94 V-0)
Back Up	LC-V	6 – 9 years	Trickle standard type		●
	LC-X	10 – 12 years	Trickle long life type	●	
	LC-P	10 – 12 years	Trickle long life type		●
	LC-QA	15 years	Trickle super long life type		●
	UP-RW	6 – 9 years	High power standard type	●	
	UP-PW	10 – 12 years	High power long life type		●
Back Up and Main Power	LC-R	6 – 9 years	Trickle and cycle standard type	●	
Main Power	LC-CA	-	Cycle long life type	●	
	LC-XC	-	Cycle long life type	●	

LC Series – Trickle Design Life 6 – 9 Years

Model Number	Nominal Voltage (V)	Rated Capacity (Ah) 20 hour rate	Dimensions (mm)				Mass approx. (kg)	Page	VdS VdS N°
			Length	Width	Height	Approx. Total Height			
LC-R061R3P*1	6	1.3	97	24	50	55	0.3	36	-
LC-R063R4P*1	6	3.4	134	34	60	66	0.6	38	-
LC-R064R5P*1	6	4.5	70	48	102	108	0.7	40	-
LC-R067R2P*1	6	7.2	151	34	94	100	1.3	42	-
LC-R0612P*1	6	12	151	50	94	100	2.0	44	-
LC-R0615P	6	15	151	50	94	100	2.1	46	-
LC-R121R3PG	12	1.3	97	47.5	50	55	0.6	48	G196049
LC-R122R2PG	12	2.2	177	34	60	66	0.8	50	G188151
LC-R123R4PG	12	3.4	134	67	60	66	1.2	52	G191053
LC-R124R5P	12	4.5	70	97	102	108	1.5	54	-
LC-R127R2PG*2	12	7.2	151	64.5	94	100	2.5	56	G193046
LC-RA1212PG	12	12	151	98	94	100	3.8	58	G100001
LC-RA1215P	12	15	151	98	94	100	4.2	60	-
LC-R1233P	12	33	195.6	130	155	180	12.0	62	-
LC-V1233P	12	33	195.6	130	155	180	11.1	64	-

LC Series – Trickle Design Life 10 – 12 Years

Model Number	Nominal Voltage (V)	Rated Capacity (Ah) 20 hour rate	Dimensions (mm)				Mass approx. (kg)	Page	VdS VdS N°
			Length	Width	Height	Approx. Total Height			
LC-P067R2P	6	7.2	151	34	94	100	1.30	66	-
LC-P0612P	6	12	151	50	94	100	2.00	68	-
LC-X06200P*1	6	200	407	173	210	250	41.00	70	-
LC-P122R2P	12	2.2	177	34	60	66	0.80	72	-
LC-P123R4P	12	3.4	134	67	60	66	1.20	74	-
LC-P127R2P	12	7.2	151	64.5	94	100	2.50	76	-
LC-PA1212P	12	12	151	98	94	100	3.80	78	-
LC-XD1217PG/APG	12	17	181	76	167	167	6.50	80	G104101

*1 This battery is also available with a flame retardant battery case resin (UL94 V-0).
*2 LC-R127R2P is available with flame retardant case resin (UL94 V-0) but with no VdS certification.

11 | Battery Index

LC Series – Trickle Design Life 10 – 12 Years

Model Number	Nominal Voltage (V)	Rated Capacity (Ah)	Dimensions (mm)				Mass approx. (kg)	Page	VdS VdS N°
		20 hour rate	Length	Width	Height	Approx. Total Height			
LC-X1220P/AP*1	12	20	181	76	167	167	6.6	82	-
LC-X1224PG/APG	12	24	165	125	175	179.5/175	9.0	84	G198049
LC-X1228P/AP*1	12	28	165	125	175	179.5/175	11.0	86	-
LC-X1238PG/APG	12	38	197	165	175	180/175	13.0	88	G100002
LC-X1242P/AP*1	12	42	197	165	175	180/175	16.0	90	-
LC-X1265PG	12	65	350	166	175	175	20.0	92	G199090
LC-X1275P*1	12	75	350	166	175	175	24.0	94	-
LC-XB12100P*1	12	100	407	173	210	236	37.0	96	-
LC-X12120P*1	12	120	407	173	210	236	37.0	98	-

LC Series – Cycle Long Life

Model Number	Nominal Voltage (V)	Rated Capacity (Ah)	Dimensions (mm)				Mass approx. (kg)	Page	VdS VdS N°
		20 hour rate	Length	Width	Height	Approx. Total Height			
LC-CA1212P	12	12	151	98	94	100	3.8	100	-
LC-CA1215P	12	15	151	98	94	100	4.2	102	-
LC-CA1216P	12	16	151	98	99	105	4.7	104	-
LC-XC1222P	12	22	181	76	167	167	6.6	106	-
LC-XC1228P	12	28	165	125	175	179.5	10.0	108	-
LC-XC1238P	12	38	197	165	175	179.5	15.0	110	-

UP-RW / PW Series – Trickle Design 6 – 9 and 10 – 12 Years

Model Number	Nominal Voltage (V)	Rated Power (W)	Dimensions (mm)				Mass approx. (kg)	Page	VdS VdS N°
		10 minute rate	Length	Width	Height	Approx. Total Height			
UP-RW0645P*1,2	6	135	151	34	94	100	1.3	112	-
UP-RW1220P*1,2	12	120	140	38.5	94	100	1.4	114	-
UP-RW1228P*1,2	12	200	151	64.5	94	100	1.9	116	-
UP-RWA1232P1/P2*1,2	12	192	151	51	94	100	2.0	118	-
UP-RW1236P*1,2	12	224	151	64.5	94	100	2.1	120	-
UP-RW1245P*1,2	12	270	151	64.5	94	100	2.6	122	-
UP-PW1245P*3	12	270	151	64.5	94	100	2.6	124	-

LC-QA Series – Trickle Design Life 15 Years

Model Number	Nominal Voltage (V)	Rated Capacity (Ah)	Dimensions (mm)				Mass approx. (kg)	Page	VdS VdS N°
			Length	Width	Height	Approx. Total Height			
LC-QA06210TP	6	210	407	173	210	250	36.5	126	-
LC-QA1224AP	12	24	165	125	175	175	10.0	128	-
LC-QA1242P/AP	12	42	197	165	175	180	16.0	130	-
LC-QA1270P	12	70	350	166	175	175	23.5	132	-
LC-QA12110TP	12	110	407	173	210	236	36.0	134	-

*1 This battery is also available with a flame retardant battery case resin (UL94 V-0). *2 Trickle Design Life 6 – 9 Years. *3 Trickle Design Life 10 – 12 Years.

12 | Standards

Product Standards

Alarm security market / VdS approved batteries

Model Number	Nominal Voltage (V)	Rated Capacity (Ah)	VdS VdS N°	Country of origin
LC-R121R3PG	12	1,3	G196049	China
LC-R122R2PG	12	2,2	G188151	China
LC-R123R4PG	12	3,4	G191053	China
LC-R127R2PG	12	7,2	G193046	China
LC-RA1212PG	12	12	G100001	China
LC-XD1217PG/APG	12	17	G104101	China
LC-X1224PG/APG	12	24	G198049	China
LC-X1238PG/APG	12	38	G100002	China
LC-X1265PG	12	65	G199090	China

UL Standard

All our VRLA batteries are in compliance with UL 1989 (Standby Batteries) – file number MH 13723. UL 1989 requires that the battery is free from the hazard of bursting, that is, when the battery is overcharged the vent valve opens to release internal pressure.

JIS (Japan Industrial Standard)

All our VRLA batteries are in compliance with JIS C 8702 (almost harmonized with IEC 61056).

Factory Standards

ISO 9001 / ISO 14001

Quality Management System (ISO 9001) defines what the organization does to ensure that its products or services satisfy the customer's quality requirements and comply with any regulations applicable to those products or services. ISO 14000 is primarily concerned with "environmental management". In plain language, this means what the organization does to minimize harmful effects on the environment caused by its activities.

OHSAS 18001

OHSAS 18001 is an Occupation Health and Safety Assessment Series for health and safety management systems. It is intended to help organizations to control occupational health and safety risks. It was developed in response to widespread demand for a recognized standard against which to be certified and assessed.

Other applicable Standards

Following documents are established by consensus and approved by a recognized body, that provides, for common and repeated use, rules, guidelines or characteristics for activities or their results, aimed at the achievement of the optimum degree of order in a given context.

NOTE: Standards should be based on the consolidated results of science, technology and experience, and aimed at the promotion of optimum community benefits.

IEC standards cover a vast range of technologies from power generation, transmission and distribution to home appliances and office equipment, semiconductors, fibre optics, batteries, solar energy, nanotechnology and marine energy as well as many others.

IEC standards are also being adopted as harmonized standards by other certifying bodies such as BSI (Great Britain), CSA (Canada), UL & ANSI/INCITS (USA), SABS (South Africa), SAI (Australia), SPC/GB (China), DIN (Germany) and JIS (Japan). IEC standards harmonized by other certifying bodies generally have some noted differences from the original IEC standard.

12 | Standards

IEC 61056

Specifies the general requirements, functional characteristics and methods of test for all general purpose lead acid cells and batteries of the valve regulated type for either cyclic or float charge application; in portable equipment, for instance, incorporated in tools, toys, or in static emergency, or uninterruptible power supply and general power supplies.

The cells of this kind of lead-acid battery may either have flat-plate electrodes in prismatic containers or have spirally wound pairs of electrodes in cylindrical containers. The sulfuric acid in these cells is immobilized between the electrodes either by absorption in a microporous structure or in a gelled form.

IEC 61056-1

General purpose lead acid batteries (valve-regulated types)
Part 1: General requirements, functional characteristics-
Method of test

IEC 61056-2

General purpose lead acid batteries (valve-regulated types)
Part 2: Dimensions, terminals and marking

IEC 60896-21

Stationary lead-acid batteries. Valve regulated types.
Methods of test.

This part of IEC 60896 applies to all stationary lead-acid cell and monobloc batteries of the valve regulated type for float charge applications, (i.e. permanently connected to a load and to a d.c. power supply), in a static location, (i.e. not generally intended to be moved from place to place) and incorporated into stationary equipment or installed in battery rooms for use in telecom uninterruptible power supply (UPS), utility switching, emergency power or similar applications.

Following standards are adopted as harmonized standards.

EN 50272-2 [DIN VDE 0510 Part 2]

Safety Requirements for Secondary Batteries and Battery Installations. Safety requirements for batteries and battery systems-stationary batteries. The ventilation requirements for safety rooms are specified herein. Apply the VRLA formula together with our batteries.

GOST-R (GOSSTANDART of RUSSIA)

Certifies quality of actually supplied goods and their compliance with contractual terms. A quality certificate contains a profile of goods or confirms their compliance with certain standards or specifications of a delivery order. A certificate of compliance is intended for certification of goods produced by Russian companies or shipped to Russia by an importer-company.

13 | Individual Data Sheets

LC-R061R3P*1



Contents indicated (including the recycle marking, etc.) are subject to change without notice.

For main and standby power supplies.
Expected trickle design life: 6 – 9 years at 20°C according to Eurobat.

Dimensions (mm)

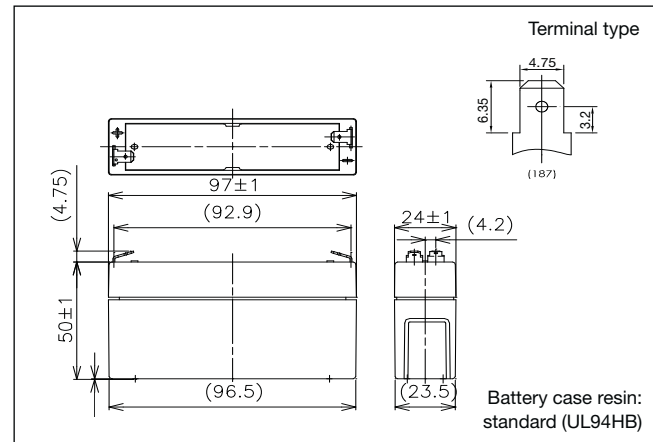

Specifications

Nominal voltage	6V	
Nominal capacity (20 hour rate)	1.3Ah	
Dimensions	Length	97mm
	Width	24mm
	Height	50mm
	Total Height	55mm
Approx. mass	0.3kg	
Terminal	Faston 187	

Duration of discharge vs Discharge current

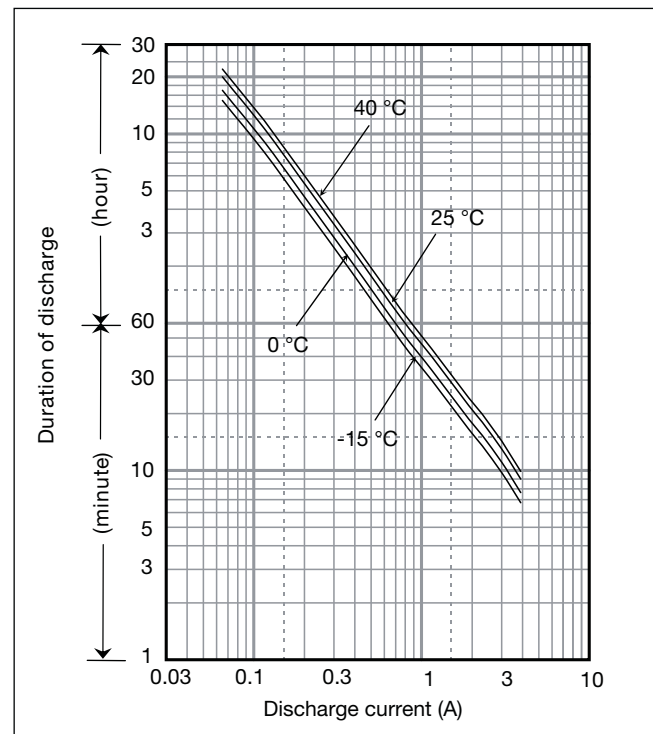

Characteristics

Capacity (25°C)	20 hour rate	1.3Ah
	10 hour rate	1.2Ah
	5 hour rate	1.05Ah
	1 hour rate	0.85Ah
Internal resistance	Fully charged battery (25°C)	50mΩ
Temperature dependency of capacity (20 hour rate)	40°C	102%
	25°C	100%
	0°C	85%
	-15°C	65%
Self discharge (25°C)	After 3 months	91%
	After 6 months	82%
	After 12 months	64%

Watt Table

Cut-off V	(Wattage/Battery)																							
	3min	5min	10min	15min	20min	30min	45min	1h	1.5h	2h	3h	4h	5h	6h	10h	20h	24h							
4.8V	39.1	30.8	20.1	15.4	12.9	9.61	6.78	5.42	3.73	2.89	2.15	1.65	1.36	1.10	0.726	0.393	0.328							
4.95V	36.2	28.9	19.7	15.3	12.7	9.51	6.74	5.42	3.66	2.86	2.14	1.64	1.35	1.09	0.723	0.392	0.327							
5.1V	33.4	27.1	19.2	15.0	12.5	9.40	6.68	5.32	3.58	2.79	2.12	1.63	1.34	1.08	0.715	0.391	0.326							
5.25V	29.7	24.3	17.8	13.9	11.8	9.19	6.57	5.21	3.51	2.69	2.08	1.62	1.33	1.07	0.712	0.390	0.325							
5.4V	25.1	21.4	15.9	13.0	11.5	8.87	6.47	5.10	3.41	2.57	2.04	1.60	1.30	1.05	0.704	0.388	0.323							

Ampere Table

Cut-off V	(Ampere/Battery)																							
	3min	5min	10min	15min	20min	30min	45min	1h	1.5h	2h	3h	4h	5h	6h	10h	20h	24h							
4.8V	7.02	5.53	3.59	2.67	2.22	1.64	1.16	0.921	0.632	0.488	0.361	0.276	0.228	0.183	0.121	0.0655	0.0547							
4.95V	6.52	5.18	3.52	2.65	2.18	1.63	1.15	0.921	0.619	0.484	0.359	0.274	0.226	0.182	0.120	0.0654	0.0545							
5.1V	6.01	4.86	3.43	2.60	2.15	1.61	1.14	0.903	0.607	0.471	0.356	0.273	0.224	0.181	0.119	0.0652	0.0543							
5.25V	5.34	4.35	3.18	2.42	2.04	1.57	1.12	0.885	0.594	0.455	0.350	0.271	0.222	0.178	0.119	0.0650	0.0542							
5.4V	4.51	3.85	2.83	2.26	1.99	1.52	1.10	0.867	0.578	0.433	0.343	0.267	0.217	0.176	0.117	0.0646	0.0538							

*1 This battery is also available with a flame retardant battery case resin (UL94 V-0).

Charging Method

Cycle use	Control voltage: 7.25 - 7.45V; Initial current: 0.52A or smaller
Trickle use	Control voltage: 6.8 - 6.9V; Initial current: 0.195A or smaller

Influence of Temperature on Trickle life

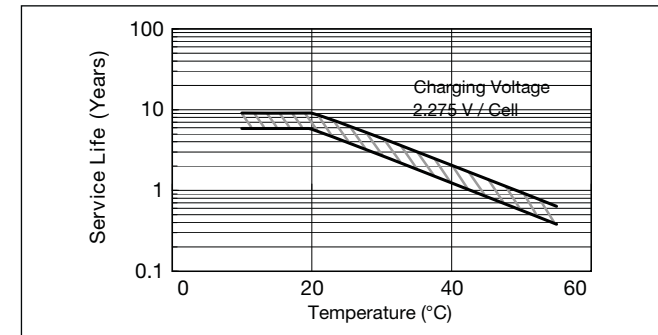

Residual capacity vs storage period

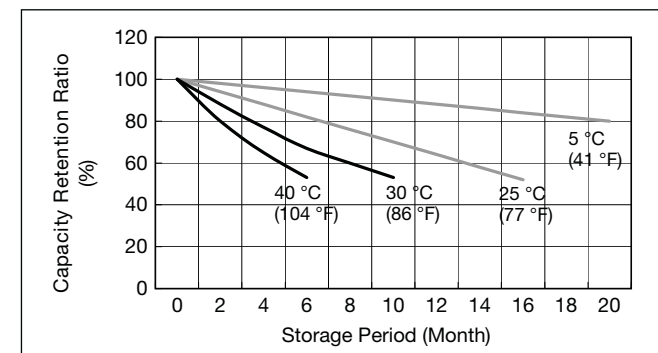

Constant-voltage and constant-current charge characteristics for Trickle use

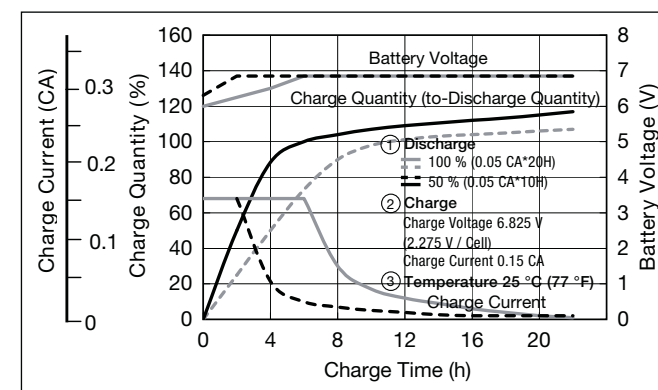

Cut off voltage

Discharge current	0.065A - 0.26A	0.26A - 0.65A	0.65A - 1.3A	1.3A - 2.6A	2.6A - 3.9A
Cut off voltage (V)	5.25	5.1	4.95	4.65	4.35

Cycle life vs Depth of discharge

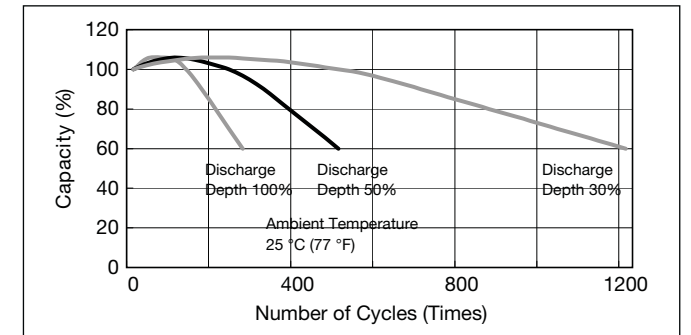

Discharge capacity by temperature and by discharge current

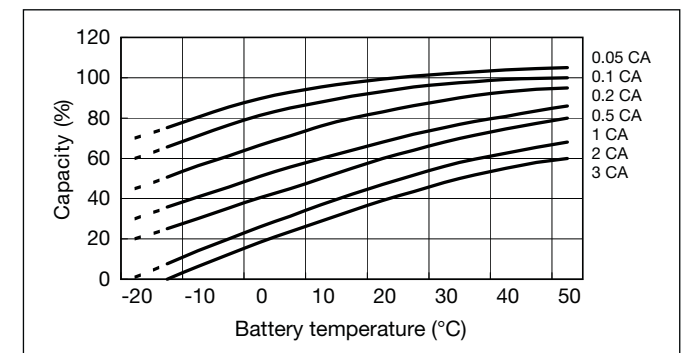

Constant-voltage and constant-current charge characteristics for Cycle use

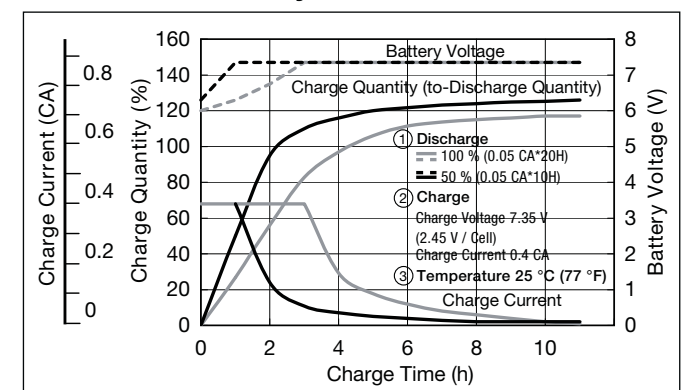

Discharge characteristics

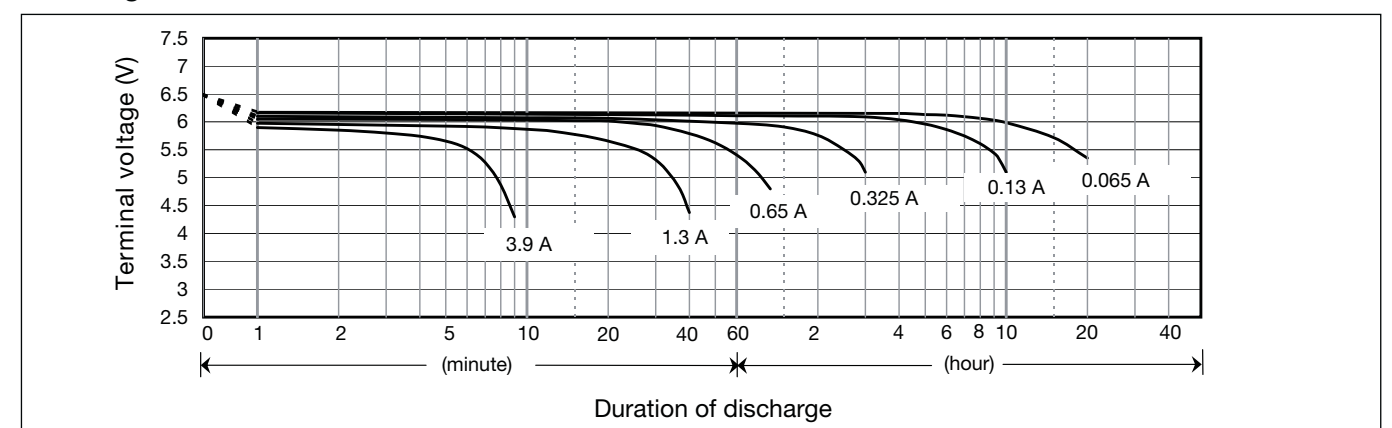

LC-R063R4P*1



For main and standby power supplies.
Expected trickle design life: 6 – 9 years at 20°C according to Eurobat.

Dimensions (mm)

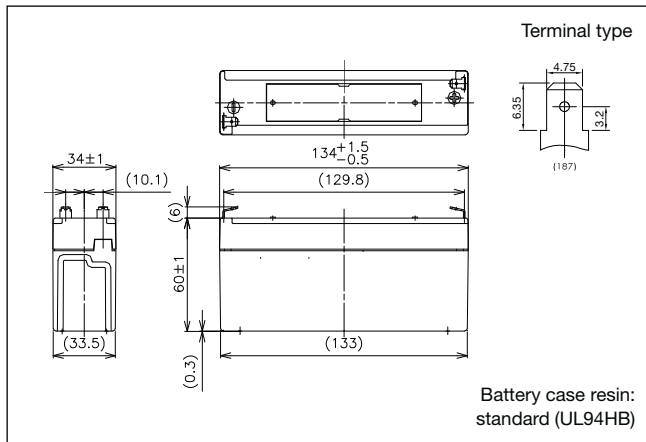

Specifications

Nominal voltage	6V	
Nominal capacity (20 hour rate)	3.4Ah	
Dimensions	Length	134mm
	Width	34mm
	Height	60mm
	Total Height	66mm
Approx. mass	0.62kg	
Terminal	Faston 187	

Duration of discharge vs Discharge current

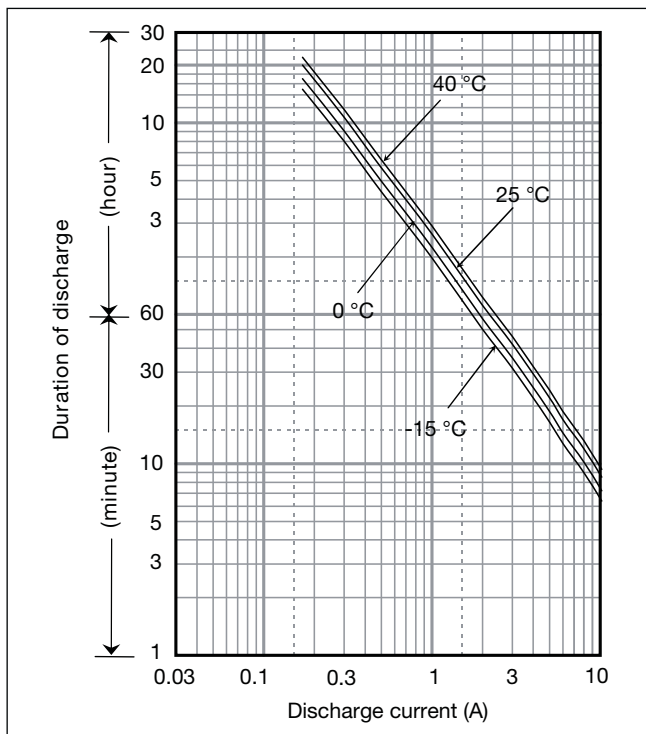

Characteristics

Capacity (25°C)	20 hour rate	3.4Ah
	10 hour rate	3.0Ah
	5 hour rate	2.7Ah
	1 hour rate	2.1Ah
Internal resistance	Fully charged battery (25°C)	30mΩ
Temperature dependency of capacity (20 hour rate)	40°C	102%
	25°C	100%
	0°C	85%
	-15°C	65%
Self discharge (25°C)	After 3 months	91%
	After 6 months	82%
	After 12 months	64%

Watt Table

Cut-off V	(Wattage/Battery)																							
	3min	5min	10min	15min	20min	30min	45min	1h	1.5h	2h	3h	4h	5h	6h	10h	20h	24h							
4.8V	102	80.6	52.6	40.2	33.7	25.1	17.7	14.2	9.76	7.55	5.62	4.32	3.56	2.86	1.90	1.03	0.858							
4.95V	94.8	75.6	51.6	39.9	33.1	24.9	17.6	14.2	9.56	7.49	5.59	4.29	3.54	2.85	1.89	1.03	0.856							
5.1V	87.4	70.8	50.2	39.1	32.6	24.6	17.5	13.9	9.37	7.30	5.54	4.26	3.51	2.83	1.87	1.02	0.853							
5.25V	77.7	63.4	46.5	36.4	30.9	24.0	17.2	13.6	9.17	7.04	5.45	4.23	3.48	2.80	1.86	1.02	0.850							
5.4V	65.6	56.1	41.5	33.9	30.1	23.2	16.9	13.4	8.92	6.71	5.34	4.18	3.39	2.75	1.84	1.01	0.844							

Ampere Table

Cut-off V	(Ampere/Battery)																							
	3min	5min	10min	15min	20min	30min	45min	1h	1.5h	2h	3h	4h	5h	6h	10h	20h	24h							
4.8V	18.4	14.4	9.40	6.99	5.81	4.30	3.02	2.41	1.65	1.27	0.944	0.722	0.595	0.478	0.316	0.171	0.143							
4.95V	17.0	13.6	9.21	6.94	5.71	4.25	3.00	2.41	1.62	1.27	0.940	0.718	0.590	0.476	0.315	0.171	0.143							
5.1V	15.7	12.7	8.97	6.80	5.62	4.20	2.97	2.36	1.59	1.23	0.930	0.713	0.586	0.472	0.312	0.170	0.142							
5.25V	14.0	11.4	8.31	6.33	5.34	4.11	2.93	2.31	1.55	1.19	0.916	0.708	0.581	0.467	0.310	0.170	0.142							
5.4V	11.8	10.1	7.41	5.90	5.19	3.97	2.88	2.27	1.51	1.13	0.897	0.699	0.567	0.459	0.307	0.169	0.141							

*1 This battery is also available with a flame retardant battery case resin (UL94 V-0).

Charging Method

Cycle use	Control voltage: 7.25 - 7.45V; Initial current: 1.36A or smaller
Trickle use	Control voltage: 6.8 - 6.9V; Initial current: 0.51A or smaller

Influence of Temperature on Trickle life

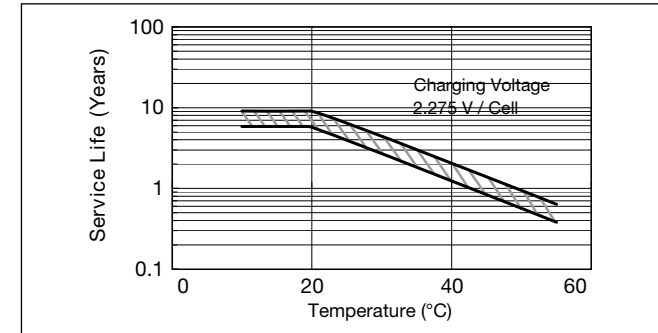

Cut off voltage

Discharge current	0.17A - 0.68A	0.68A - 1.7A	1.7A - 3.4A	3.4A - 6.8A	6.8A - 10.2A
Cut off voltage (V)	5.25	5.1	4.95	4.65	4.35

Cycle life vs Depth of discharge

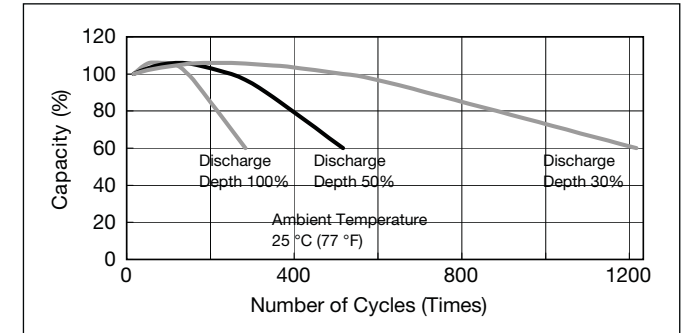

Residual capacity vs storage period

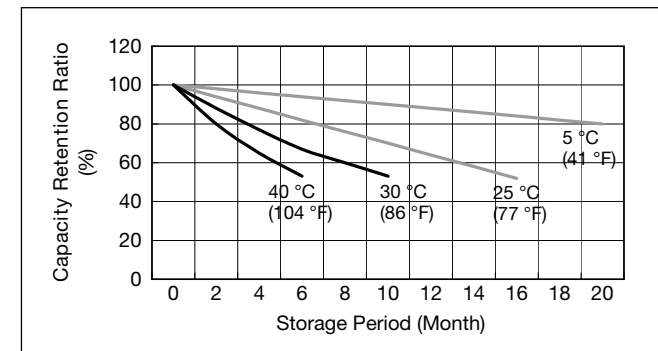

Discharge capacity by temperature and by discharge current

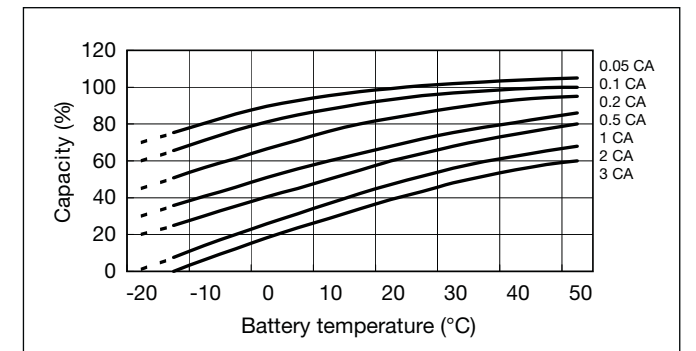

Constant-voltage and constant-current charge characteristics for Trickle use

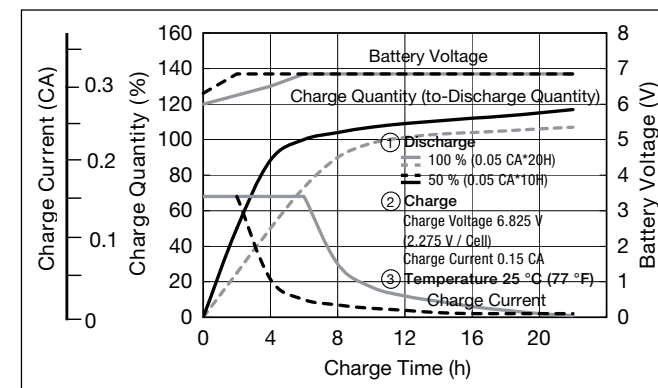

Constant-voltage and constant-current charge characteristics for Cycle use

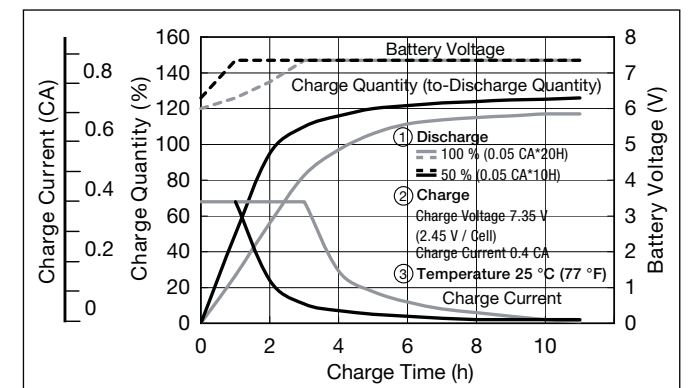

Discharge characteristics

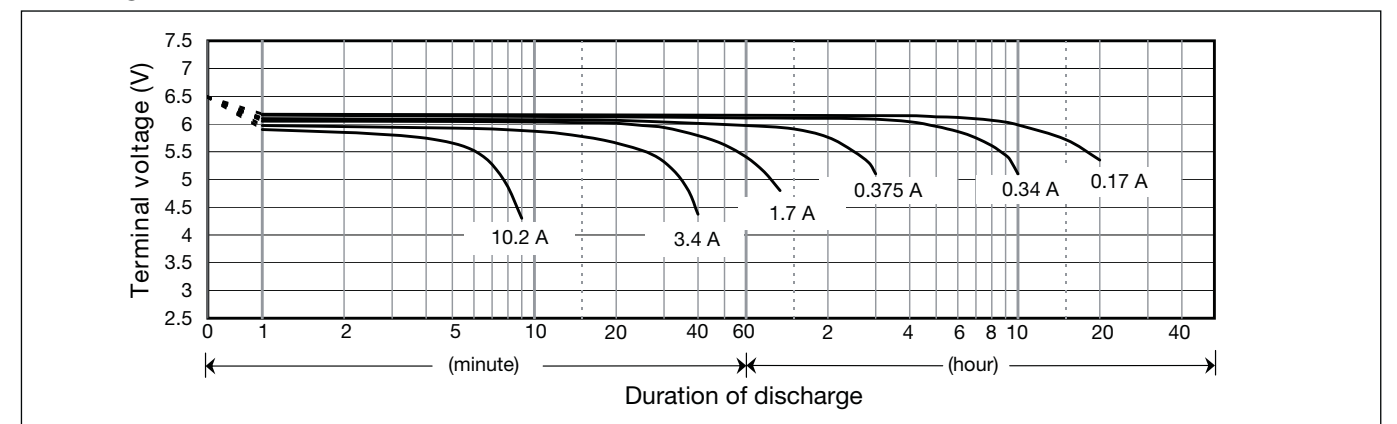

LC-R064R5P*1



Contents indicated (including the recycle marking, etc.) are subject to change without notice.

For main and standby power supplies.
Expected trickle design life: 6 – 9 years at 20°C according to Eurobat.

Dimensions (mm)

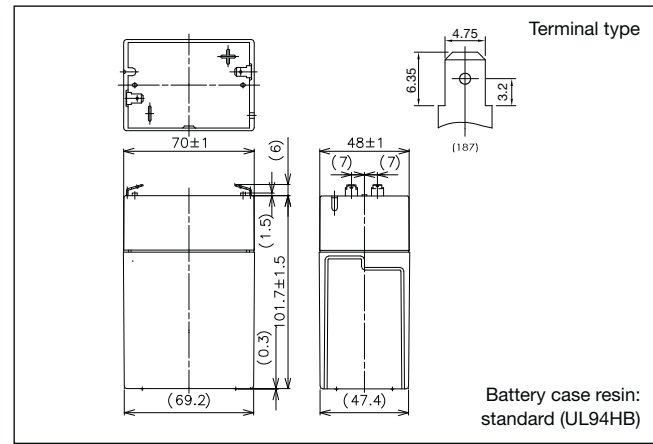

Specifications

Nominal voltage	6V	
Nominal capacity (20 hour rate)	4.5Ah	
Dimensions	Length	70mm
	Width	48mm
	Height	102mm
	Total Height	108mm
Approx. mass	0.72kg	
Terminal	Faston 187	

Duration of discharge vs Discharge current

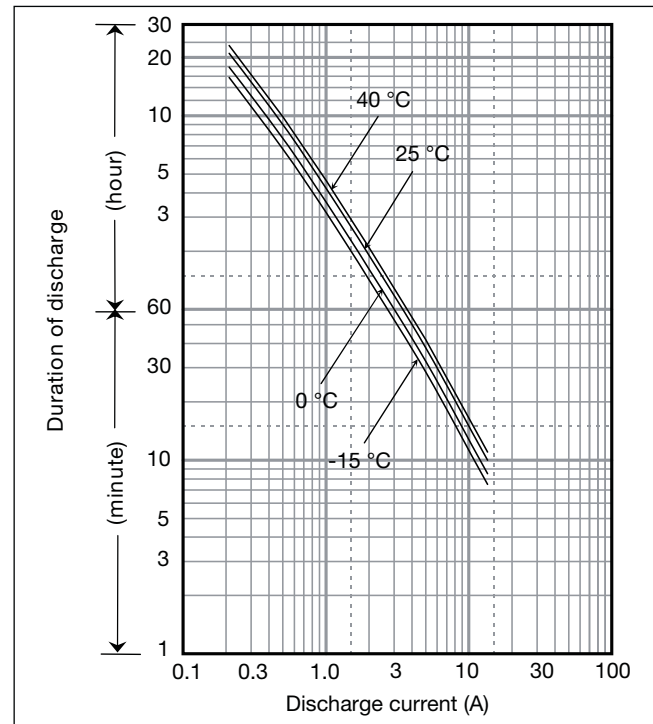

Characteristics

Capacity (25°C)	20 hour rate	4.5Ah
	10 hour rate	4.0Ah
	5 hour rate	3.6Ah
	1 hour rate	2.8Ah
Internal resistance	Fully charged battery (25°C)	20mΩ
	Temperature dependency of capacity (20 hour rate)	40°C: 102%, 25°C: 100%, 0°C: 85%, -15°C: 65%
Self discharge (25°C)	After 3 months	91%
	After 6 months	82%
	After 12 months	64%

Watt Table

Cut-off V	(Wattage/Battery)																		
	3min	5min	10min	15min	20min	30min	45min	1h	1.5h	2h	3h	4h	5h	6h	10h	20h	24h		
4.8V	135	107	69.7	53.2	44.6	33.3	23.5	18.8	12.9	9.99	7.44	5.71	4.72	3.79	2.51	1.36	1.136		
4.95V	125	100	68.3	52.8	43.9	32.9	23.3	18.8	12.7	9.92	7.40	5.68	4.68	3.78	2.50	1.36	1.133		
5.1V	116	94	66.5	51.8	43.1	32.5	23.1	18.4	12.4	9.66	7.33	5.64	4.64	3.75	2.48	1.35	1.129		
5.25V	103	84	61.6	48.2	41.0	31.8	22.7	18.0	12.1	9.32	7.21	5.60	4.60	3.70	2.46	1.35	1.125		
5.4V	87	74	55.0	44.9	39.9	30.7	22.4	17.7	11.8	8.88	7.07	5.53	4.49	3.64	2.44	1.34	1.118		

Ampere Table

Cut-off V	(Ampere/Battery)																		
	3min	5min	10min	15min	20min	30min	45min	1h	1.5h	2h	3h	4h	5h	6h	10h	20h	24h		
4.8V	24.3	19.13	12.44	9.25	7.69	5.69	4.00	3.19	2.19	1.69	1.25	0.956	0.788	0.633	0.419	0.227	0.189		
4.95V	22.6	17.94	12.19	9.19	7.56	5.63	3.98	3.19	2.14	1.68	1.24	0.950	0.781	0.630	0.417	0.226	0.189		
5.1V	20.8	16.81	11.88	9.00	7.44	5.56	3.94	3.13	2.10	1.63	1.23	0.944	0.775	0.625	0.413	0.226	0.188		
5.25V	18.5	15.06	11.00	8.38	7.06	5.44	3.88	3.06	2.06	1.58	1.21	0.938	0.769	0.618	0.411	0.225	0.188		
5.4V	15.6	13.31	9.81	7.81	6.88	5.25	3.81	3.00	2.00	1.50	1.19	0.925	0.750	0.608	0.406	0.224	0.186		

*1 This battery is also available with a flame retardant battery case resin (UL94 V-0).

Charging Method

Trickle use	Control voltage: 6.8 - 6.9V; Initial current: 0.675A or smaller
-------------	---

Influence of Temperature on Trickle life

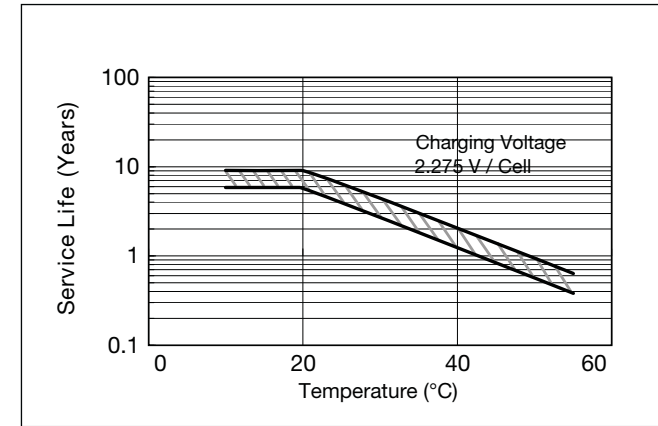

Cut off voltage

Discharge current	0.225 A - 0.9A	0.9A - 2.25A	2.25A - 4.5A	4.5A - 9A	9A - 13.5A
Cut off voltage (V)	5.25	5.1	4.95	4.65	4.35

Residual capacity vs storage period

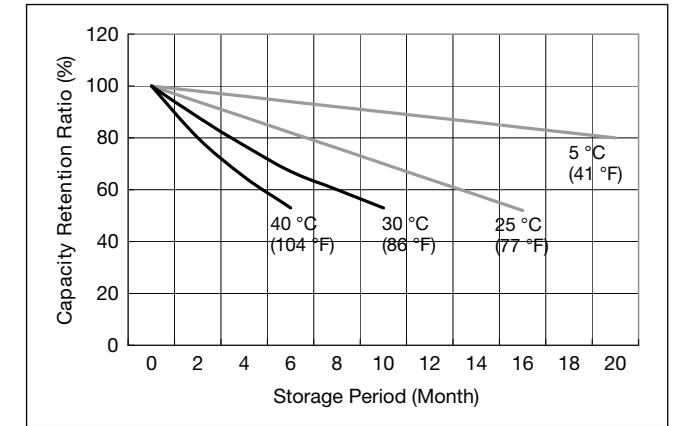

Constant-voltage and constant-current charge characteristics for Trickle use

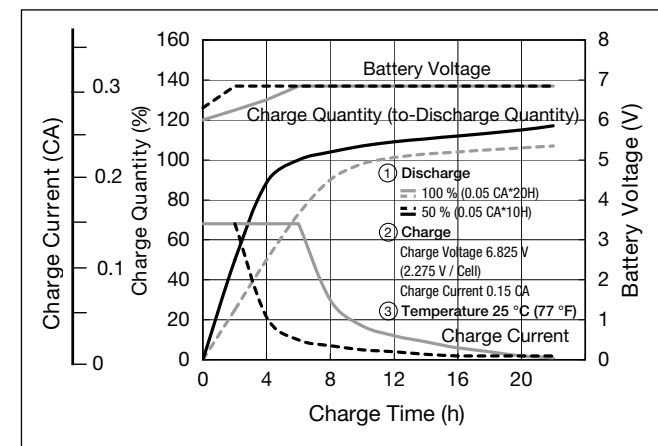

Discharge capacity by temperature and by discharge current

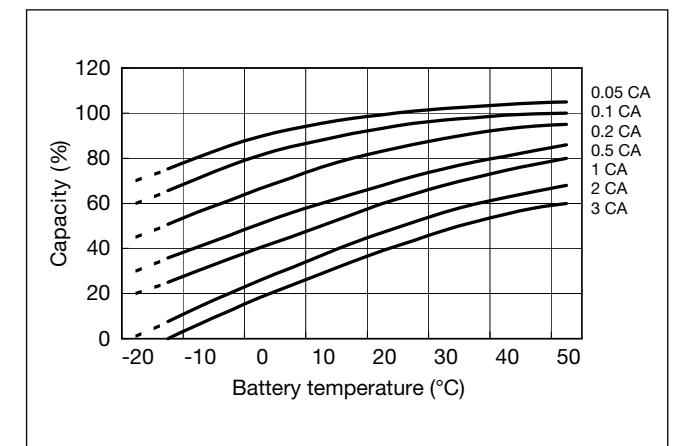

Discharge characteristics

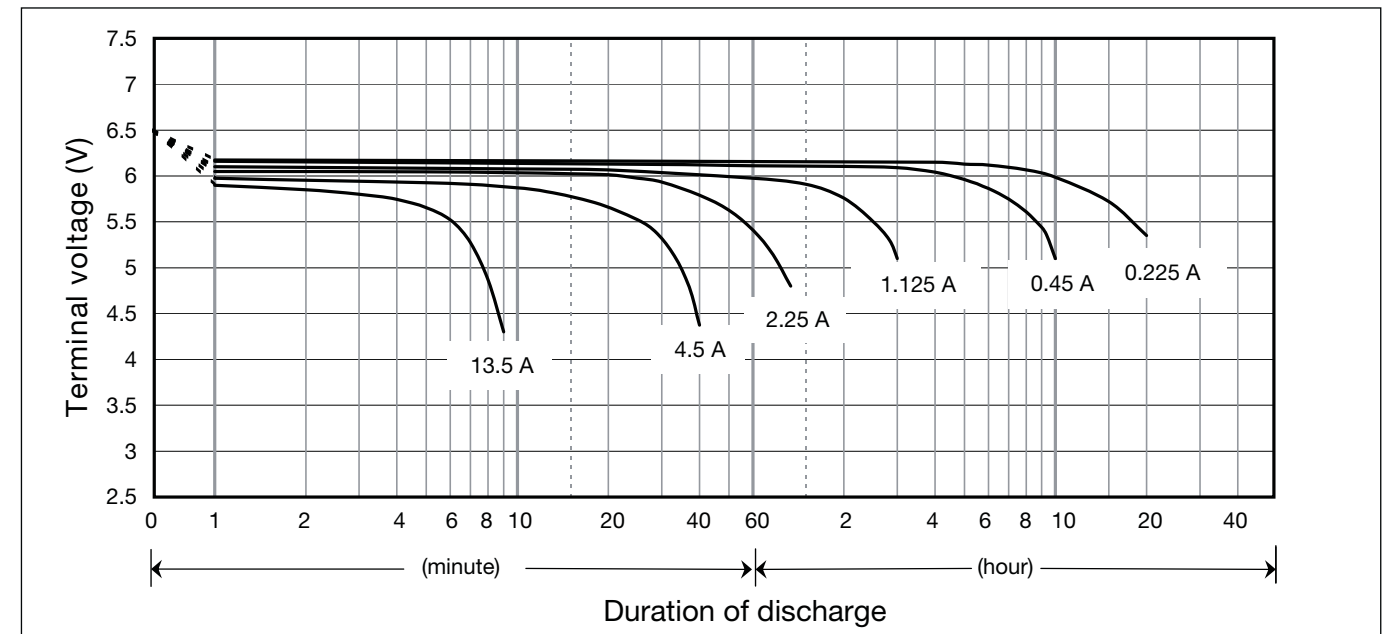

LC-R067R2P*1



Contents indicated (including the recycle marking, etc.) are subject to change without notice.

For main and standby power supplies.
Expected trickle design life: 6 – 9 years at 20°C according to Eurobat.

Dimensions (mm)

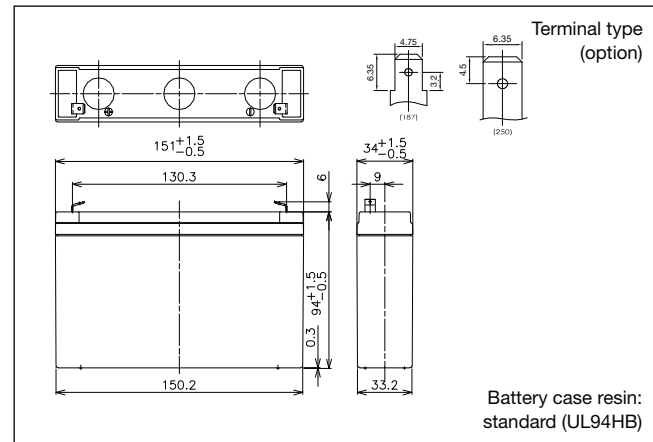

Specifications

Nominal voltage	6V	
Nominal capacity (20 hour rate)	7.2Ah	
Dimensions	Length	151mm
	Width	34mm
	Height	94mm
	Total Height	100mm
Approx. mass	1.26kg	
Terminal	Faston 187 or Faston 250 with hole	

Duration of discharge vs Discharge current

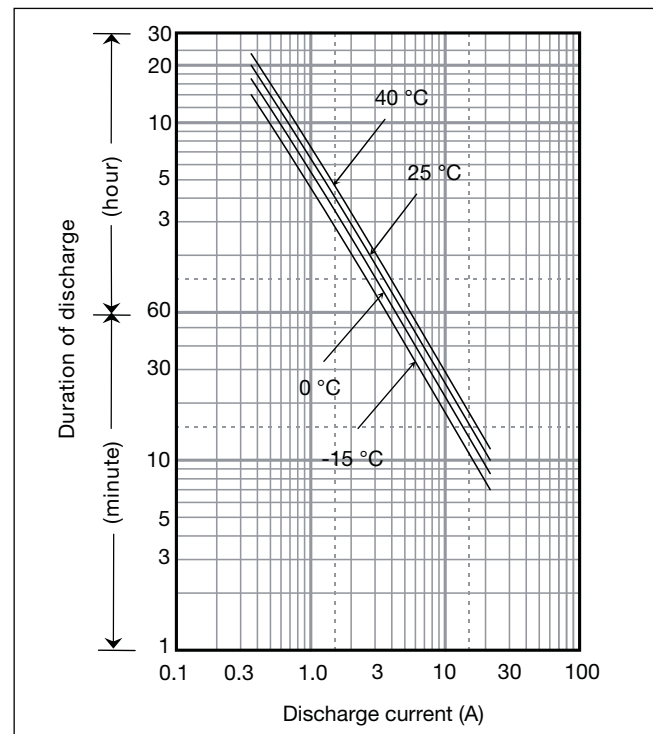

Characteristics

Capacity (25°C)	20 hour rate 10 hour rate 5 hour rate 1 hour rate	7.2Ah 6.8Ah 6.3Ah 4.9Ah
Internal resistance	Fully charged battery (25°C)	11mΩ
Temperature dependency of capacity (20 hour rate)	40°C 25°C 0°C -15°C	102% 100% 85% 65%
Self discharge (25°C)	After 3 months After 6 months After 12 months	91% 82% 64%

Watt Table

Cut-off V	(Wattage/Battery)																
	3min	5min	10min	15min	20min	30min	45min	1h	1.5h	2h	3h	4h	5h	6h	10h	20h	24h
4.8V	216	171	111	85.1	71.3	53.2	37.6	30.0	20.7	16.0	11.9	9.14	7.55	6.07	4.02	2.18	1.82
4.95V	201	160	109	84.5	70.2	52.7	37.3	30.0	20.3	15.9	11.8	9.08	7.49	6.04	4.00	2.17	1.81
5.1V	185	150	106	82.8	69.0	52.1	37.0	29.5	19.8	15.5	11.7	9.02	7.43	6.00	3.96	2.17	1.81
5.25V	165	134	99	77.1	65.5	50.9	36.4	28.9	19.4	14.9	11.5	8.96	7.37	5.92	3.94	2.16	1.80
5.4V	139	119	88	71.9	63.8	49.1	35.8	28.3	18.9	14.2	11.3	8.84	7.19	5.83	3.90	2.15	1.79

Ampere Table

Cut-off V	(Ampere/Battery)																
	3min	5min	10min	15min	20min	30min	45min	1h	1.5h	2h	3h	4h	5h	6h	10h	20h	24h
4.8V	38.9	30.6	19.9	14.8	12.3	9.1	6.4	5.1	3.5	2.7	2.00	1.50	1.26	1.00	0.67	0.36	0.30
4.95V	36.1	28.7	18.5	14.8	12.1	9.0	6.4	5.1	3.4	2.6	2.00	1.50	1.25	1.00	0.67	0.36	0.30
5.1V	33.3	26.9	19.0	14.4	11.9	8.9	6.3	5.0	3.3	2.5	1.95	1.50	1.24	1.00	0.66	0.36	0.30
5.25V	29.6	24.1	17.6	13.4	11.3	8.7	6.2	4.9	3.3	2.5	1.95	1.50	1.23	1.00	0.66	0.36	0.30
5.4V	25.0	21.3	15.7	12.5	11.0	8.4	6.1	4.8	3.2	2.4	1.90	1.50	1.20	1.00	0.65	0.35	0.30

*1 This battery is also available with a flame retardant battery case resin (UL94 V-0).

Charging Method

Cycle Use	Control voltage: 7.25 - 7.45V; Initial current: 2.88A or smaller
Trickle Use	Control voltage: 6.8 - 6.9V; Initial current: 1.08A or smaller

Influence of Temperature on Trickle life

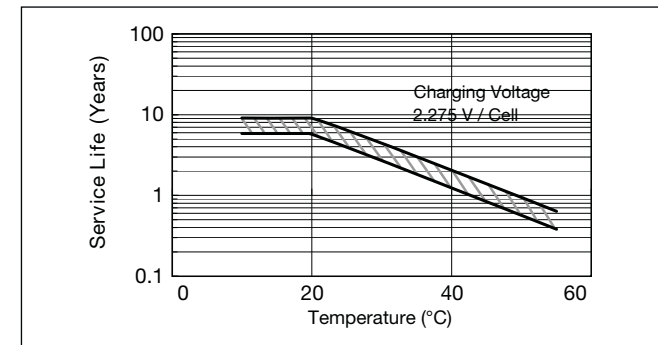

Residual capacity vs storage period

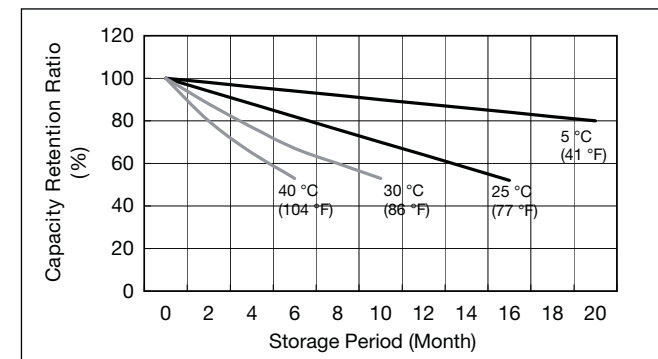

Constant-voltage and constant-current charge characteristics for Trickle use

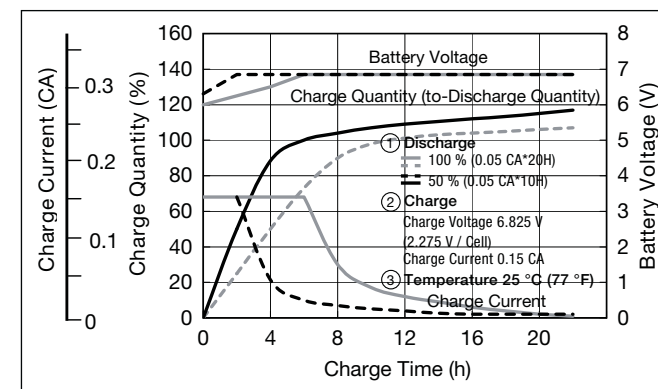

Cut off voltage

Discharge current	0.36A - 1.44A	1.44A - 3.6A	3.6A - 7.2A	7.2A - 14.4A	14.4A - 21.6A
Cut off voltage (V)	5.25	5.1	4.95	4.65	4.35

Cycle life vs Depth of discharge

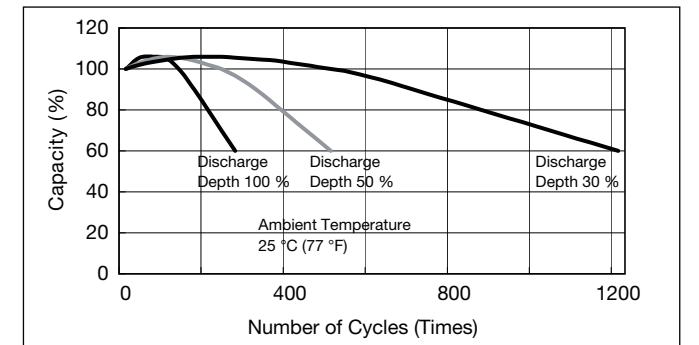

Discharge capacity by temperature and by discharge current

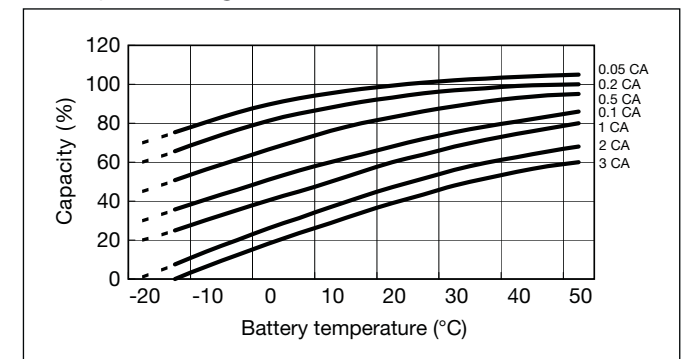

Constant-voltage and constant-current charge characteristics for Cycle use

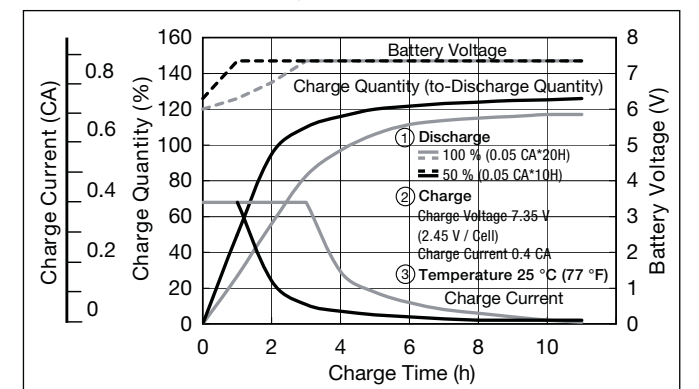

Discharge characteristics

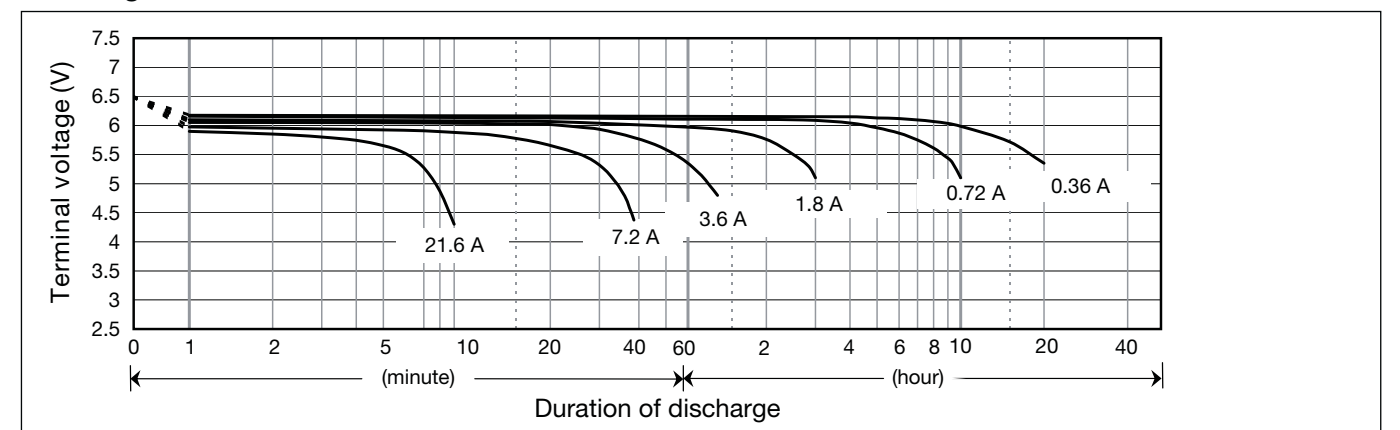

LC-R0612P*1

For main and standby power supplies.
Expected trickle design life: 6 – 9 years at 20°C according to Eurobat.



Dimensions (mm)

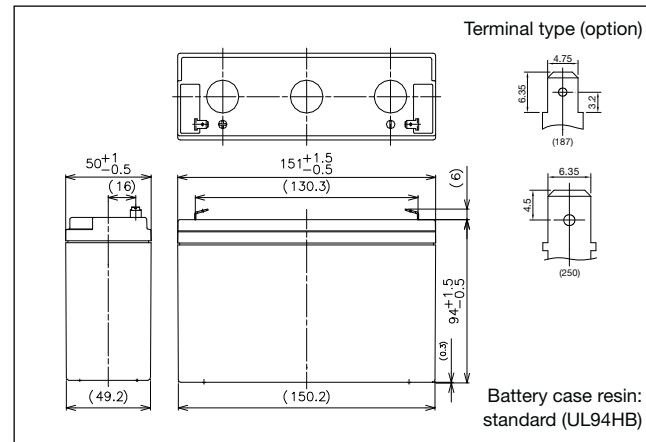

Specifications

Nominal voltage	6V	
Nominal capacity (20 hour rate)	12Ah	
Dimensions	Length	151mm
	Width	50mm
	Height	94mm
	Total Height	100mm
Approx. mass	2.00kg	
Terminal	Faston 187 or Faston 250 with hole	

Duration of discharge vs Discharge current

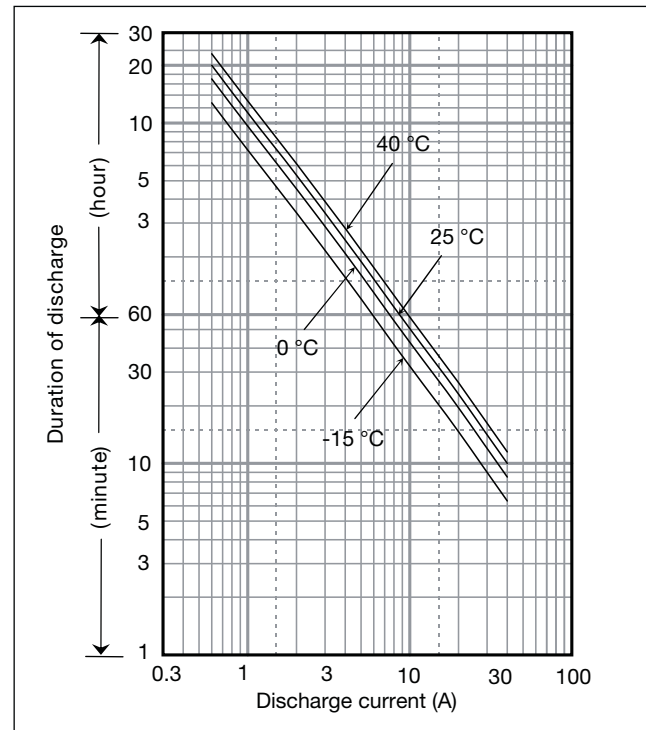

Characteristics

Capacity (25°C)	20 hour rate	12.0Ah
	10 hour rate	11.3Ah
	5 hour rate	10.4Ah
	1 hour rate	8.1Ah
Internal resistance	Fully charged battery (25°C)	15mΩ
Temperature dependency of capacity (20 hour rate)	40°C	102%
	25°C	100%
	0°C	85%
	-15°C	65%
Self discharge (25°C)	After 3 months	91%
	After 6 months	82%
	After 12 months	64%

Watt Table

Cut-off V	(Wattage/Battery)																							
	3min	5min	10min	15min	20min	30min	45min	1h	1.5h	2h	3h	4h	5h	6h	10h	20h	24h							
4.8V	340	279	192	149	124	91.3	68.7	52.4	35.1	27.2	19.0	14.4	12.0	10.9	6.66	3.61	3.01							
4.95V	325	269	186	144	121	88.3	67.5	51.8	35.0	27.1	18.9	14.4	12.0	10.9	6.66	3.61	3.01							
5.1V	304	253	181	141	118	88.3	66.9	51.2	34.5	26.9	18.7	14.4	12.0	10.8	6.60	3.61	3.01							
5.25V	278	237	171	136	115	86.0	66.3	50.1	34.2	26.6	18.4	14.3	12.0	10.8	6.60	3.60	3.00							
5.4V	247	217	161	131	113	83.1	61.6	48.9	33.1	26.0	18.1	14.2	11.9	10.7	6.54	3.59	2.99							

Ampere Table

Cut-off V	(Ampere/Battery)																							
	3min	5min	10min	15min	20min	30min	45min	1h	1.5h	2h	3h	4h	5h	6h	10h	20h	24h							
4.8V	61.1	50.1	34.3	25.9	21.3	15.6	11.7	8.90	5.95	4.60	3.20	2.41	2.01	1.81	1.11	0.602	0.502							
4.95V	58.4	48.2	33.3	25.0	20.8	15.1	11.5	8.80	5.92	4.58	3.18	2.41	2.01	1.81	1.11	0.602	0.502							
5.1V	54.6	45.4	32.4	24.5	20.3	15.1	11.4	8.70	5.85	4.55	3.15	2.41	2.00	1.80	1.10	0.601	0.501							
5.25V	50.0	42.6	30.6	23.6	19.9	14.7	11.3	8.50	5.80	4.50	3.10	2.40	2.00	1.80	1.10	0.600	0.500							
5.4V	44.5	38.9	28.7	22.7	19.4	14.2	10.5	8.30	5.60	4.40	3.05	2.38	1.99	1.79	1.09	0.598	0.498							

*1 This battery is also available with a flame retardant battery case resin (UL94 V-0).

Charging Method

Cycle use	Control voltage: 7.25 - 7.45V; Initial current: 4.8A or smaller
Trickle use	Control voltage: 6.8 - 6.9V; Initial current: 1.8A or smaller

Influence of Temperature on Trickle life

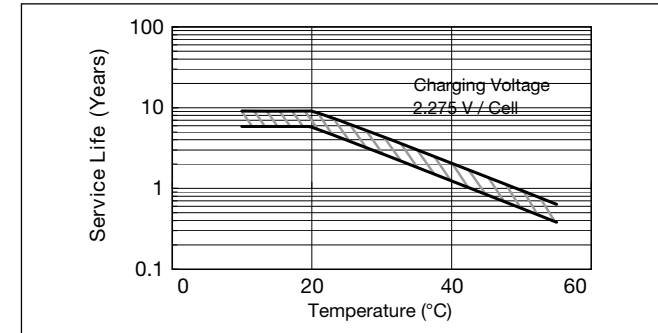

Residual capacity vs storage period

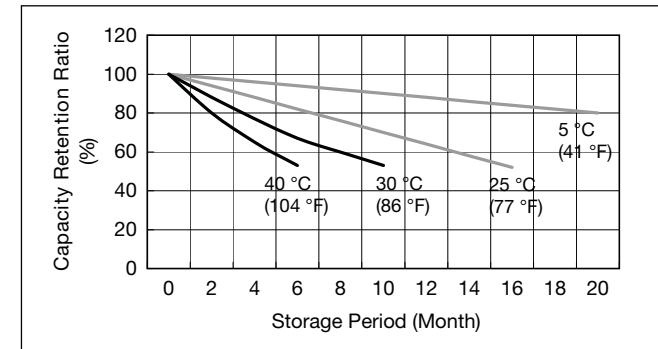

Constant-voltage and constant-current charge characteristics for Trickle use

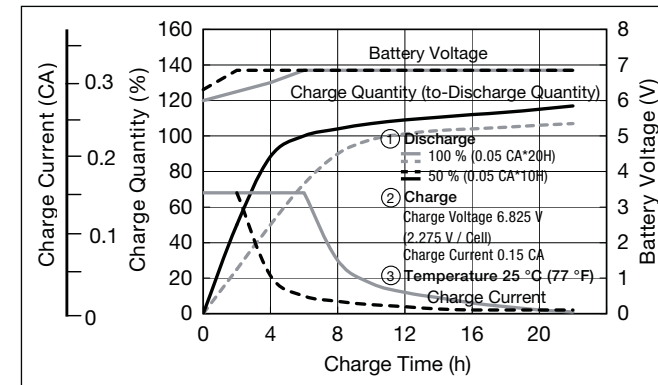

Cut off voltage

Discharge current	0.6A - 2.4A	2.4A - 6A	6A - 12A	12A - 24A	24A - 36A
Cut off voltage (V)	5.25	5.1	4.95	5.65	4.35

Cycle life vs Depth of discharge

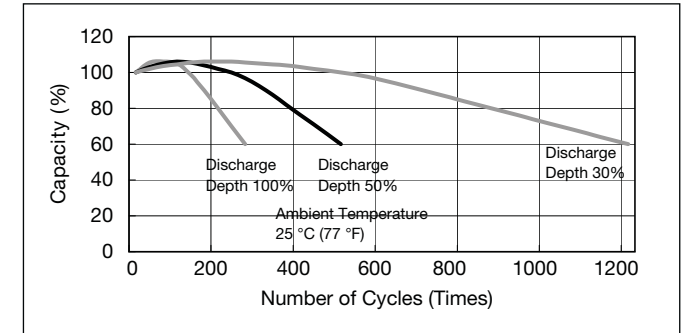

Discharge capacity by temperature and by discharge current

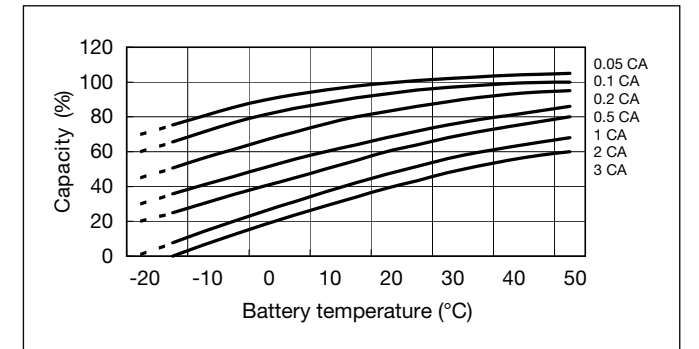

Constant-voltage and constant-current charge characteristics for Cycle use

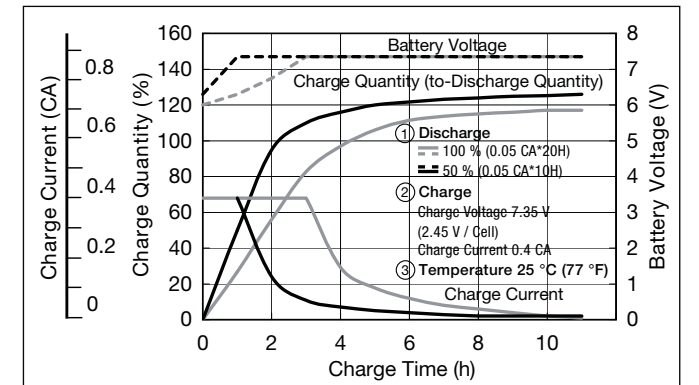

Discharge characteristics

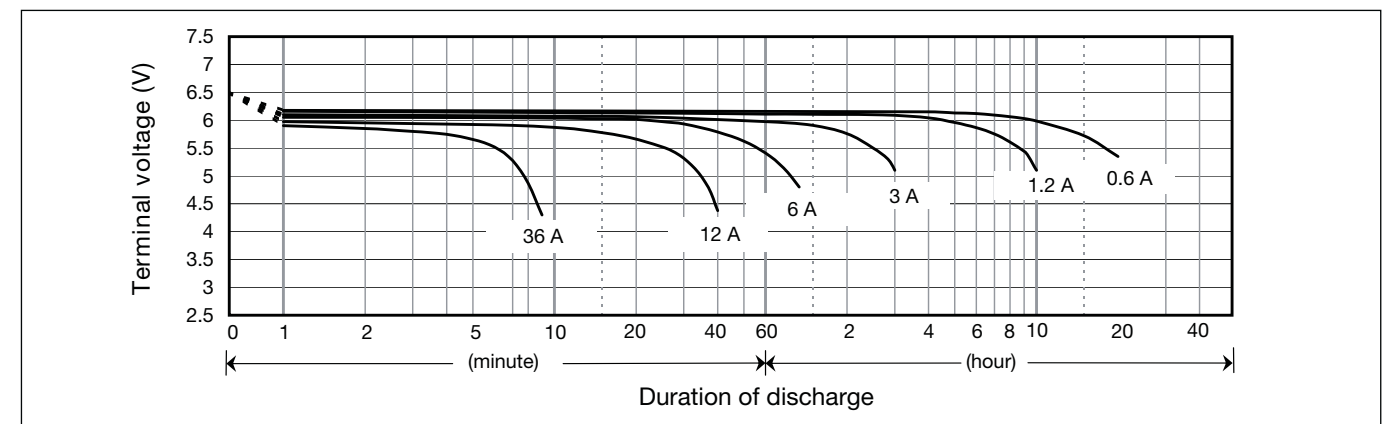

LC-R0615P



For main and standby power supplies.
Expected trickle design life: 6 – 9 years at 20°C according to Eurobat.

Dimensions (mm)

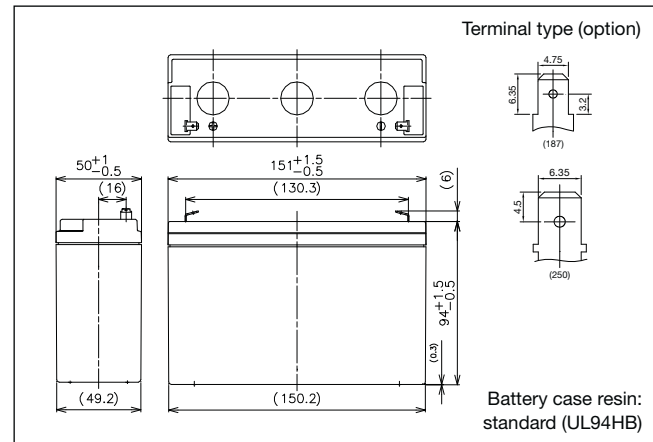

Specifications

Nominal voltage	6V	
Nominal capacity (20 hour rate)	15Ah	
Dimensions	Length	151mm
	Width	50mm
	Height	94mm
	Total Height	100mm
Approx. mass	2.10kg	
Terminal	Faston 187 or Faston 250 with hole	

Duration of discharge vs Discharge current

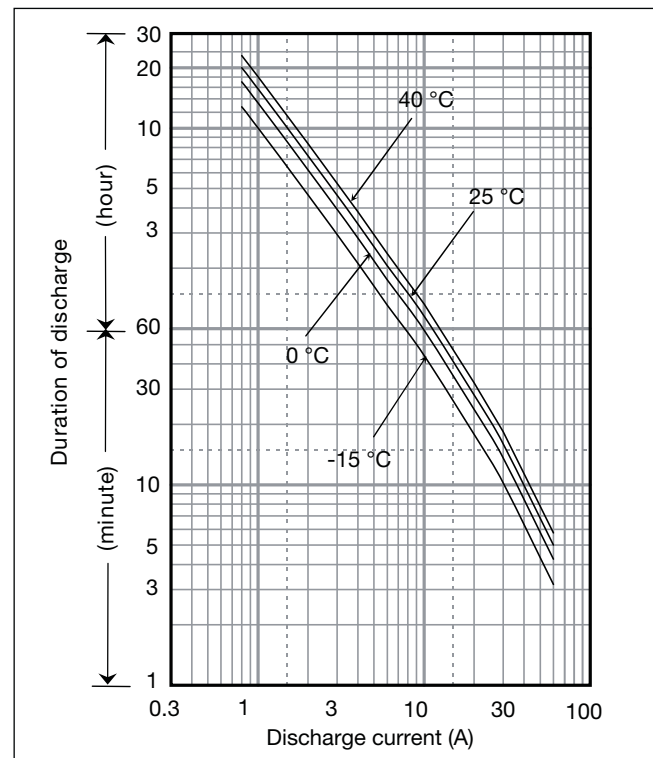

Characteristics

Capacity (25°C)	20 hour rate	12.0Ah
	10 hour rate	11.3Ah
	5 hour rate	10.4Ah
Internal resistance	Fully charged battery (25°C)	15mΩ
	1 hour rate	8.1Ah
Temperature dependency of capacity (20 hour rate)	40°C	102%
	25°C	100%
	0°C	85%
	-15°C	65%
Self discharge (25°C)	After 3 months	91%
	After 6 months	82%
	After 12 months	64%

Watt Table

Cut-off V	(Wattage/Battery)																
	3min	5min	10min	15min	20min	30min	45min	1h	1.5h	2h	3h	4h	5h	6h	10h	20h	24h
4.8V	425	341	228	175	146	108	78.7	61.7	42.0	32.5	23.6	18.0	14.9	12.6	8.08	4.38	3.65
4.95V	399	323	222	172	143	106	77.8	61.4	41.4	32.3	23.4	17.9	14.9	12.6	8.05	4.37	3.65
5.1V	370	304	216	168	140	106	77.1	60.4	40.7	31.7	23.2	17.9	14.8	12.5	7.97	4.36	3.64
5.25V	333	277	202	159	135	103	76.1	59.1	40.1	30.9	22.8	17.8	14.7	12.4	7.95	4.35	3.62
5.4V	288	249	184	150	132	100	73.1	57.8	38.8	29.8	22.4	17.5	14.4	12.2	7.87	4.33	3.60

Ampere Table

Cut-off V	(Ampere/Battery)																
	3min	5min	10min	15min	20min	30min	45min	1h	1.5h	2h	3h	4h	5h	6h	10h	20h	24h
4.8V	76.5	61.2	40.6	30.4	25.2	18.5	13.4	10.5	7.11	5.49	3.96	3.01	2.49	2.10	1.35	0.730	0.609
4.95V	71.8	58.0	39.7	29.9	24.7	18.2	13.3	10.4	7.01	5.45	3.94	3.00	2.48	2.09	1.34	0.728	0.608
5.1V	66.6	54.5	38.6	29.2	24.2	18.1	13.1	10.3	6.89	5.36	3.90	2.99	2.46	2.08	1.33	0.727	0.606
5.25V	59.9	49.8	36.1	27.6	23.3	17.6	13.0	10.0	6.78	5.22	3.84	2.97	2.45	2.07	1.33	0.725	0.604
5.4V	51.8	44.6	32.9	26.1	22.7	17.0	12.5	9.82	6.58	5.03	3.77	2.94	2.41	2.04	1.31	0.722	0.601

Charging Method

Cycle use	Control voltage: 7.25 - 7.45V; Initial current: 6A or smaller
Trickle use	Control voltage: 6.8 - 6.9V; Initial current: 2.25A or smaller

Influence of Temperature on Trickle life

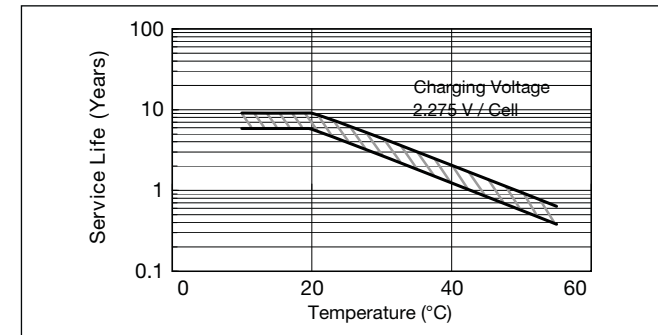

Cut off voltage

Discharge current	0.75A - 3A	3A - 7.5A	7.5A - 15A	15A - 30A	30A - 45A
Cut off voltage (V)	5.25	5.1	4.95	4.65	4.35

Cycle life vs Depth of discharge

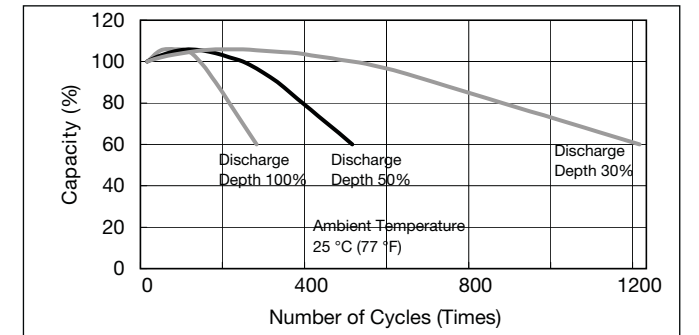

Residual capacity vs storage period

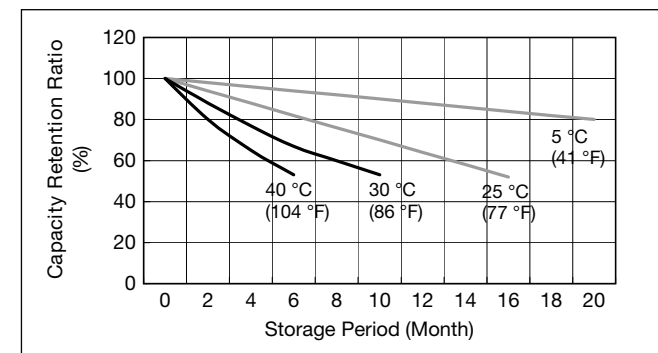

Discharge capacity by temperature and by discharge current

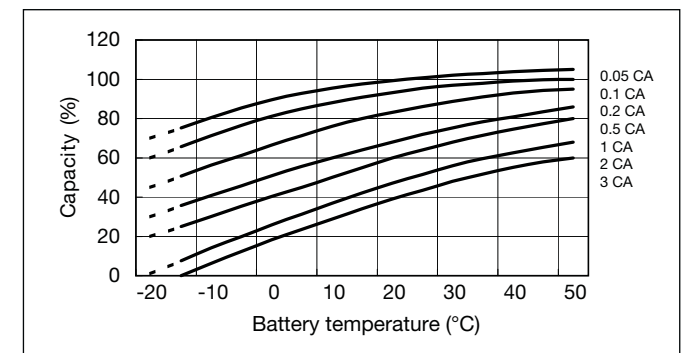

Constant-voltage and constant-current charge characteristics for Trickle use

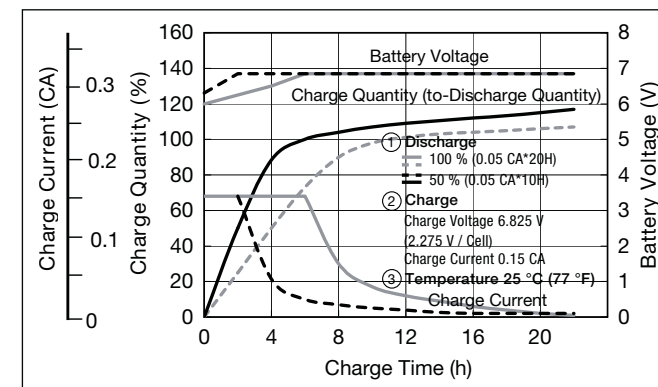

Constant-voltage and constant-current charge characteristics for Cycle use

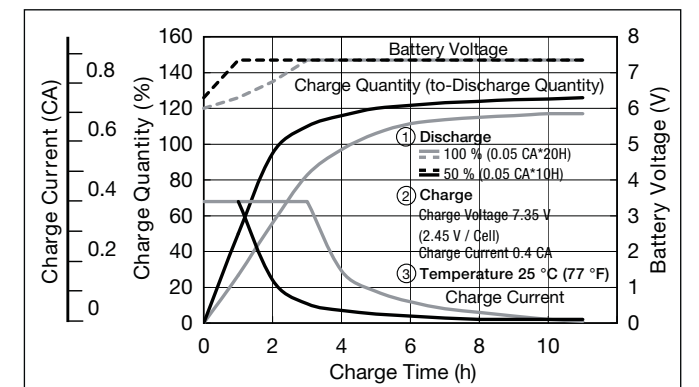

Discharge characteristics

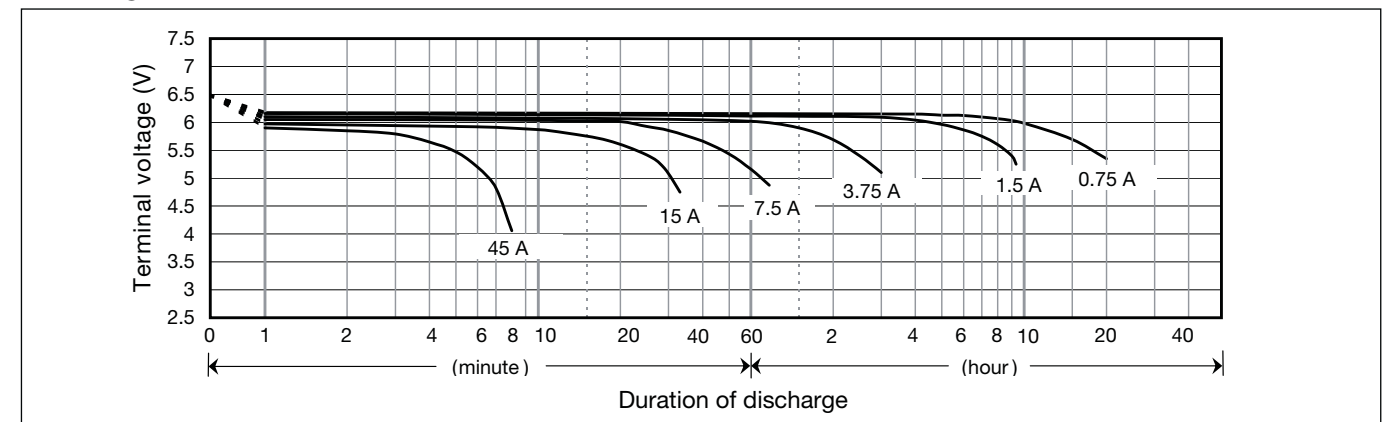

LC-R121R3PG

For main and standby power supplies. Expected trickle design life: 6 – 9 years at 20°C according to Eurobat.

VdS

G196049



Contents indicated (including the recycle marking, etc.) are subject to change without notice.

Dimensions (mm)

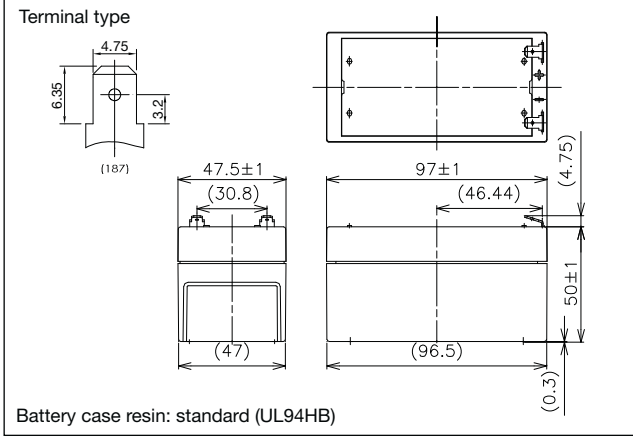

Battery case resin: standard (UL94HB)

Specifications

Nominal voltage	12V	
Nominal capacity (20 hour rate)	1.3Ah	
Dimensions	Length	97mm
	Width	47.5mm
	Height	50mm
	Total Height	55mm
Approx. mass	0.59kg	
Terminal	Faston 187	

Duration of discharge vs Discharge current

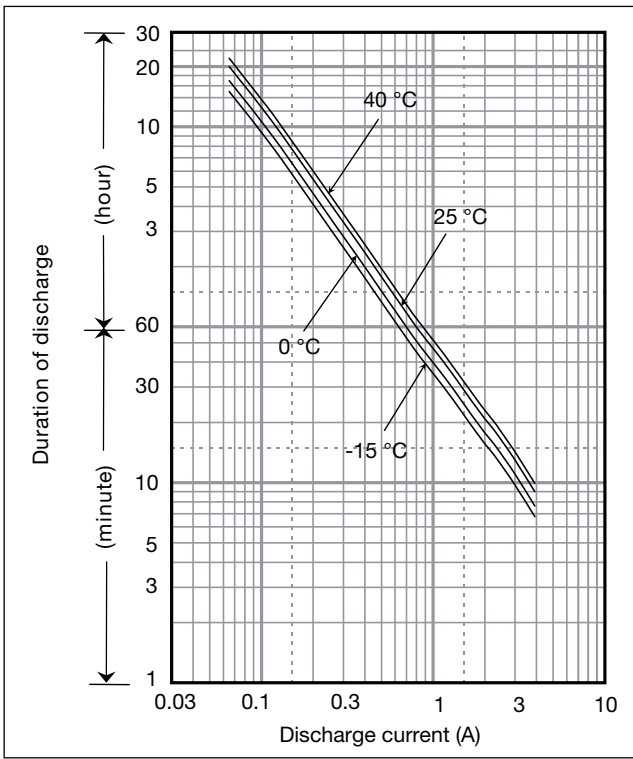

Characteristics

Capacity (25°C)	20 hour rate 10 hour rate 5 hour rate 1 hour rate	1.3Ah 1.2Ah 1.05Ah 0.85Ah
Internal resistance	Fully charged battery (25°C)	90mΩ
Temperature dependency of capacity (20 hour rate)	40°C 25°C 0°C -15°C	102% 100% 85% 65%
Self discharge (25°C)	After 3 months After 6 months After 12 months	91% 82% 64%

Watt Table

Cut-off V	(Wattage/Battery)																
	3min	5min	10min	15min	20min	30min	45min	1h	1.5h	2h	3h	4h	5h	6h	10h	20h	24h
9.6V	78.1	61.6	40.2	30.7	25.8	19.2	13.6	10.8	7.49	5.73	4.32	3.30	2.73	2.22	1.46	0.787	0.657
9.9V	72.5	57.8	39.4	30.5	25.3	19.0	13.5	10.8	7.34	5.68	4.30	3.28	2.70	2.21	1.45	0.784	0.654
10.2V	66.9	54.2	38.4	29.9	24.9	18.8	13.4	10.6	7.19	5.54	4.25	3.26	2.68	2.19	1.44	0.782	0.652
10.5V	59.4	48.5	35.6	27.8	23.7	18.4	13.1	10.4	7.04	5.34	4.19	3.24	2.66	2.16	1.43	0.780	0.650
10.8V	50.2	42.9	31.7	26.0	23.0	17.7	12.9	10.2	6.82	5.13	4.08	3.24	2.60	2.16	1.41	0.758	0.650

Ampere Table

Cut-off V	(Ampere/Battery)																
	3min	5min	10min	15min	20min	30min	45min	1h	1.5h	2h	3h	4h	5h	6h	10h	20h	24h
9.6V	7.02	5.53	3.59	2.67	2.22	1.64	1.16	0.921	0.634	0.484	0.363	0.276	0.228	0.185	0.122	0.0655	0.0655
9.9V	6.52	5.18	3.52	2.65	2.18	1.63	1.15	0.921	0.621	0.480	0.361	0.274	0.226	0.184	0.121	0.0654	0.0545
10.2V	6.01	4.86	3.43	2.60	2.15	1.61	1.14	0.903	0.609	0.468	0.358	0.273	0.224	0.183	0.120	0.0652	0.0543
10.5V	5.34	4.35	3.18	2.42	2.04	1.57	1.12	0.885	0.596	0.451	0.352	0.271	0.222	0.181	0.119	0.0650	0.0542
10.8V	4.51	3.85	2.83	2.26	1.99	1.52	1.10	0.867	0.578	0.433	0.343	0.271	0.217	0.181	0.117	0.0632	0.0542

Charging Method

Cycle use	Control voltage: 14.5 - 14.9V; Initial current 0.52A or smaller
Trickle use	Control voltage: 13.6 - 13.8V; Initial current: 1.08A or smaller

Influence of Temperature on Trickle life

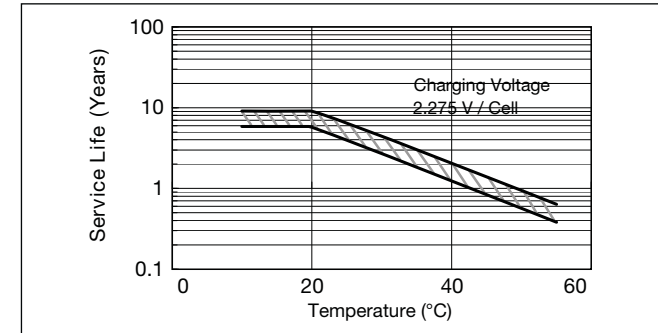

Residual capacity vs storage period

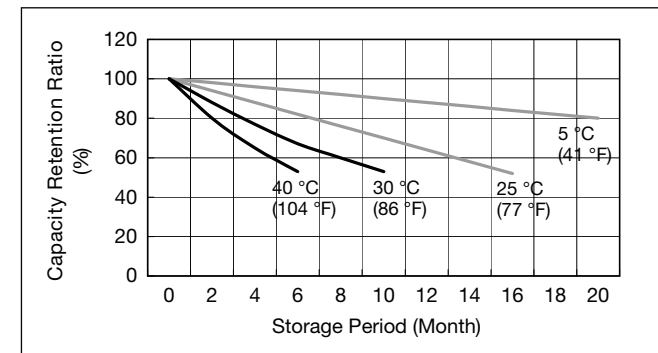

Constant-voltage and constant-current charge characteristics for Trickle use

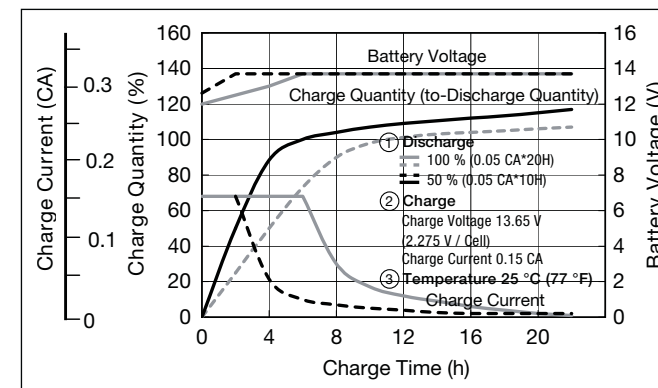

Cut off voltage

Discharge current	0.065 A - 0.26A	0.26A - 0.65A	0.65A - 1.3A	1.3A - 2.6A	2.6A - 3.9A
Cut off voltage (V)	10.5	10.2	9.9	9.3	8.7

Cycle life vs Depth of discharge

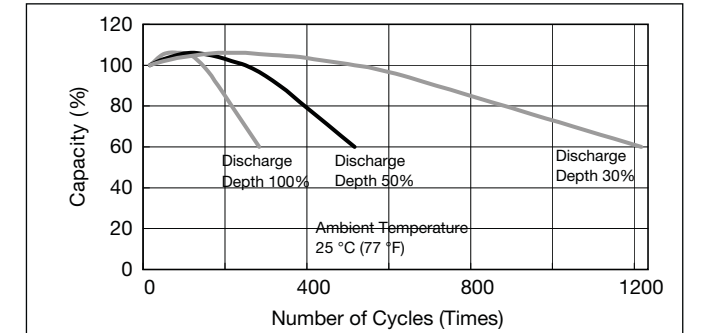

Discharge capacity by temperature and by discharge current

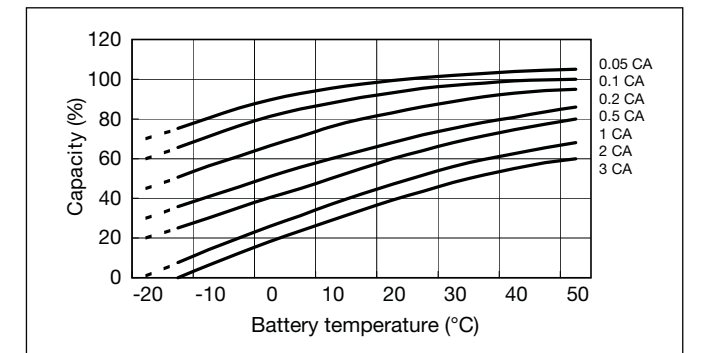

Constant-voltage and constant-current charge characteristics for Cycle use

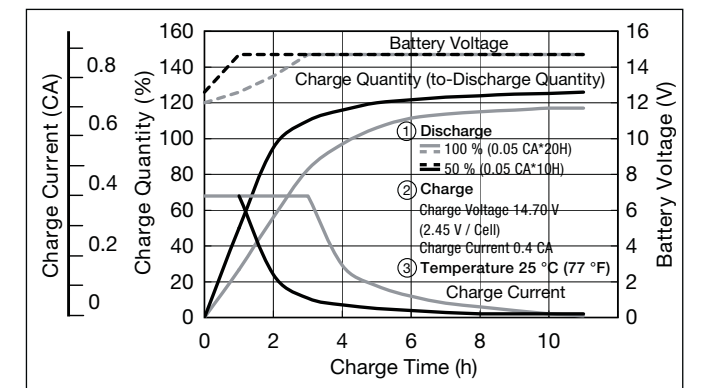

Discharge characteristics

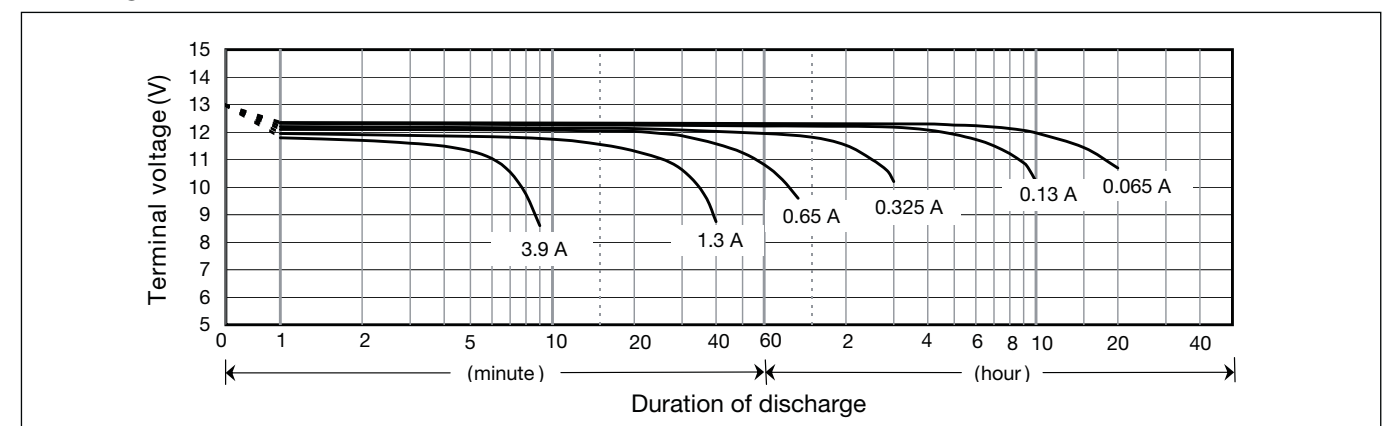

LC-R122R2PG

For main and standby power supplies. Expected trickle design life: 6 – 9 years at 20°C according to Eurobat.

VdS

G188151



Contents indicated (including the recycle marking, etc.) are subject to change without notice.

Dimensions (mm)

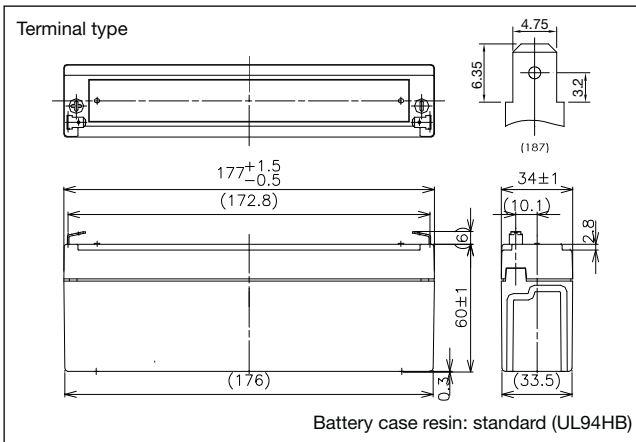

Battery case resin: standard (UL94HB)

Specifications

Nominal voltage	12V	
Nominal capacity (20 hour rate)	2.2Ah	
Dimensions	Length	177mm
	Width	34mm
	Height	60mm
	Total Height	66mm
Approx. mass	0.8kg	
Terminal	Faston 187	

Duration of discharge vs Discharge current

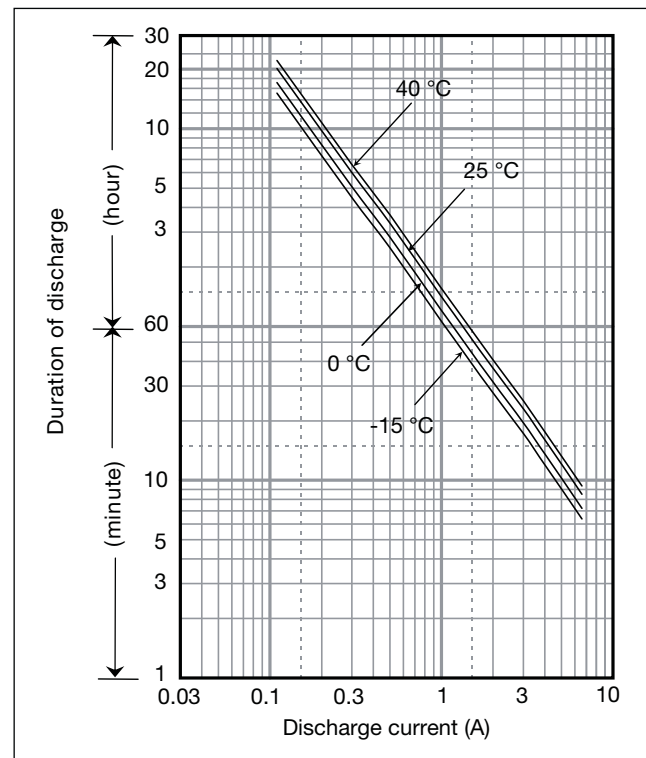

Characteristics

Capacity (25°C)	20 hour rate	2.2Ah
	10 hour rate	2.0Ah
	5 hour rate	1.8Ah
	1 hour rate	1.3Ah
Internal resistance	Fully charged battery (25°C)	70mΩ
Temperature dependency of capacity (20 hour rate)	40°C	102%
	25°C	100%
	0°C	85%
	-15°C	65%
Self discharge (25°C)	After 3 months	91%
	After 6 months	82%
	After 12 months	64%

Watt Table

(Wattage/Battery)

Cut-off V	3min	5min	10min	15min	20min	30min	45min	1h	1.5h	2h	3h	4h	5h	6h	10h	20h	24h
9.6V	132	104	68.1	52.0	43.6	32.5	23.0	18.4	12.6	9.77	7.27	5.59	4.61	3.71	2.46	1.33	1.11
9.9V	123	97.8	66.7	51.7	42.9	32.2	22.8	18.4	12.4	9.70	7.24	5.55	4.58	3.69	2.45	1.33	1.11
10.2V	113	91.6	65.0	50.6	42.2	31.8	22.6	18.0	12.1	9.44	7.16	5.51	4.54	3.66	2.42	1.32	1.10
10.5V	101	82.1	60.2	47.1	40.1	31.1	22.2	17.6	11.9	9.12	7.05	5.48	4.50	3.62	2.41	1.32	1.10
10.8V	85	72.6	53.7	43.9	39.0	30.0	21.9	17.3	11.5	8.68	6.91	5.40	4.39	3.56	2.38	1.31	1.09

Ampere Table

(Ampere/Battery)

Cut-off V	3min	5min	10min	15min	20min	30min	45min	1h	1.5h	2h	3h	4h	5h	6h	10h	20h	24h
9.6V	11.9	9.35	6.08	4.52	3.76	2.78	1.96	1.56	1.07	0.825	0.611	0.468	0.385	0.309	0.205	0.111	0.0926
9.9V	11.0	8.77	5.96	4.49	3.70	2.75	1.94	1.56	1.05	0.819	0.608	0.464	0.382	0.308	0.204	0.111	0.0923
10.2V	10.2	8.22	5.81	4.40	3.64	2.72	1.93	1.53	1.03	0.798	0.602	0.461	0.379	0.306	0.202	0.110	0.0920
10.5V	9.0	7.36	5.38	4.09	3.45	2.66	1.89	1.50	1.01	0.770	0.593	0.458	0.376	0.302	0.201	0.110	0.0917
10.8V	7.6	6.51	4.80	3.82	3.36	2.57	1.86	1.47	0.98	0.733	0.581	0.452	0.367	0.297	0.199	0.109	0.0911

Charging Method

Cycle use	Control voltage: 14.5 - 14.9V; Initial current: 0.88A or smaller
Trickle use	Control voltage: 13.6 - 13.8V; Initial current: 0.33A or smaller

Influence of Temperature on Trickle life

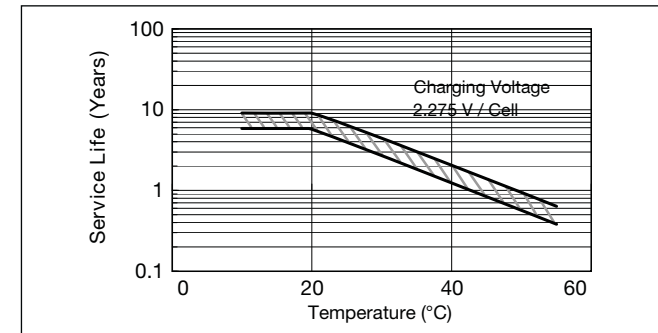

Cut off voltage

Discharge current	0.011 A - 0.44A	0.44A - 1.1A	1.1A - 2.2A	2.2A - 4.4A	4.4A - 6.6A
Cut off voltage (V)	10.5	10.2	9.9	9.3	8.7

Cycle life vs Depth of discharge

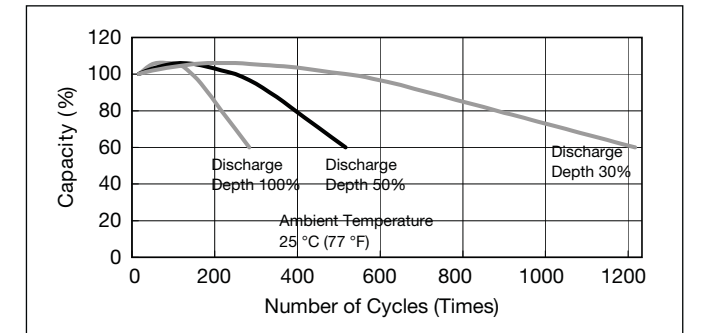

Residual capacity vs storage period

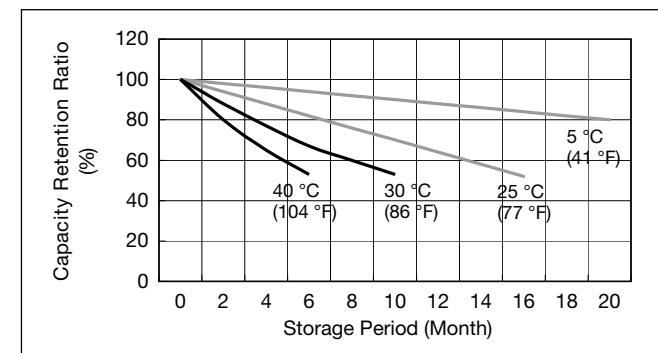

Discharge capacity by temperature and by discharge current

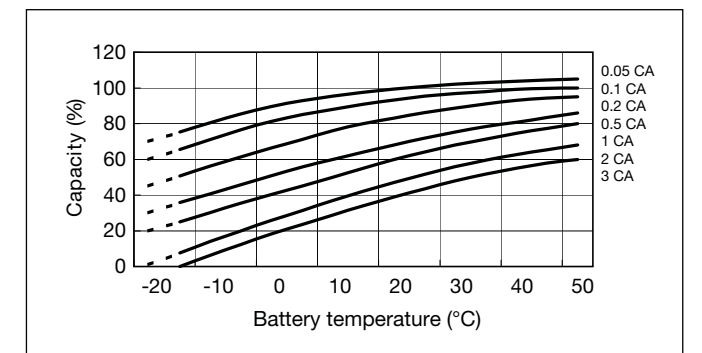

Constant-voltage and constant-current charge characteristics for Trickle use

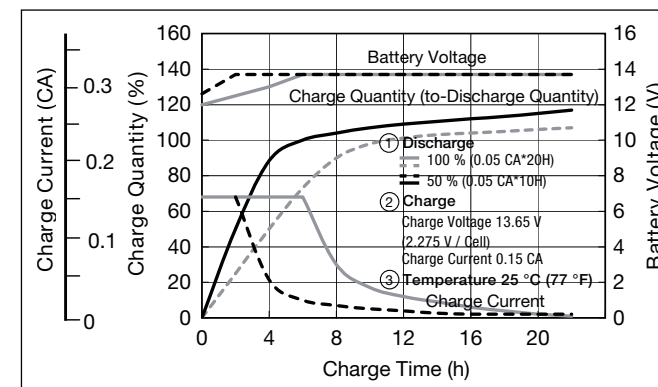

Constant-voltage and constant-current charge characteristics for Cycle use

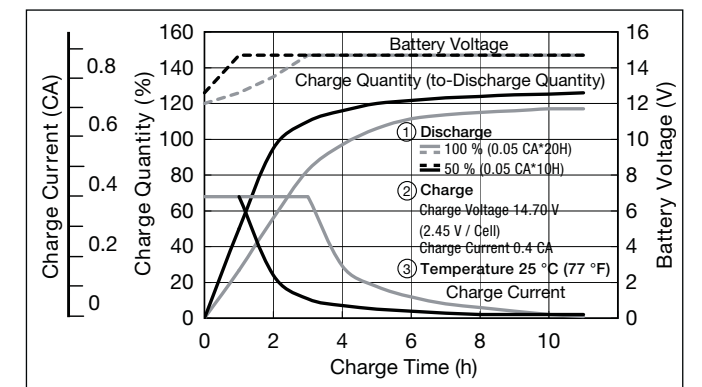

Discharge characteristics

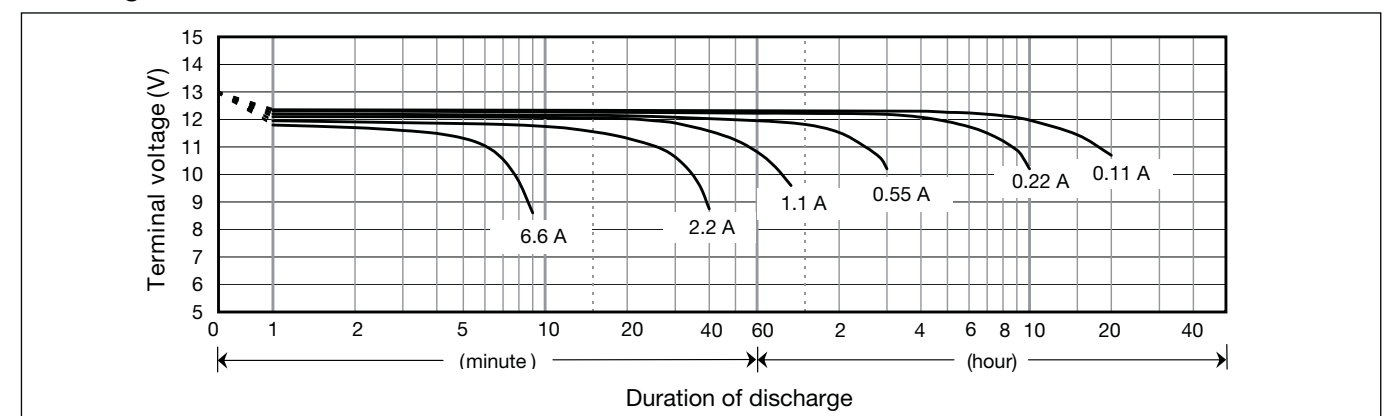

LC-R123R4PG

For main and standby power supplies. Expected trickle design life: 6 – 9 years at 20°C according to Eurobat.

VdS

G191053



Contents indicated (including the recycle marking, etc.) are subject to change without notice.

Dimensions (mm)

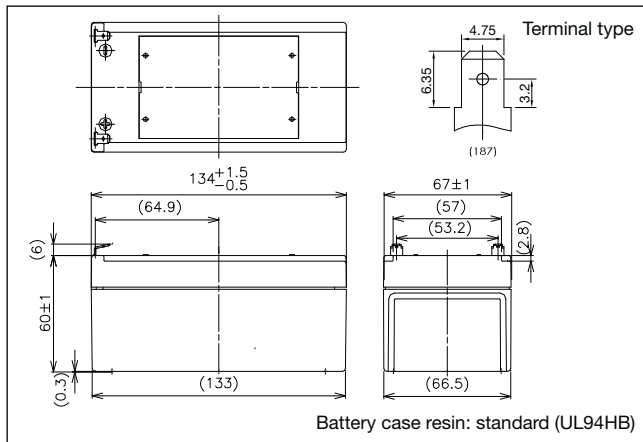

Specifications

Nominal voltage	12V	
Nominal capacity (20 hour rate)	3.4Ah	
Dimensions	Length	134mm
	Width	67mm
	Height	60mm
	Total Height	66mm
Approx. mass	1.2kg	
Terminal	Faston 187	

Duration of discharge vs Discharge current

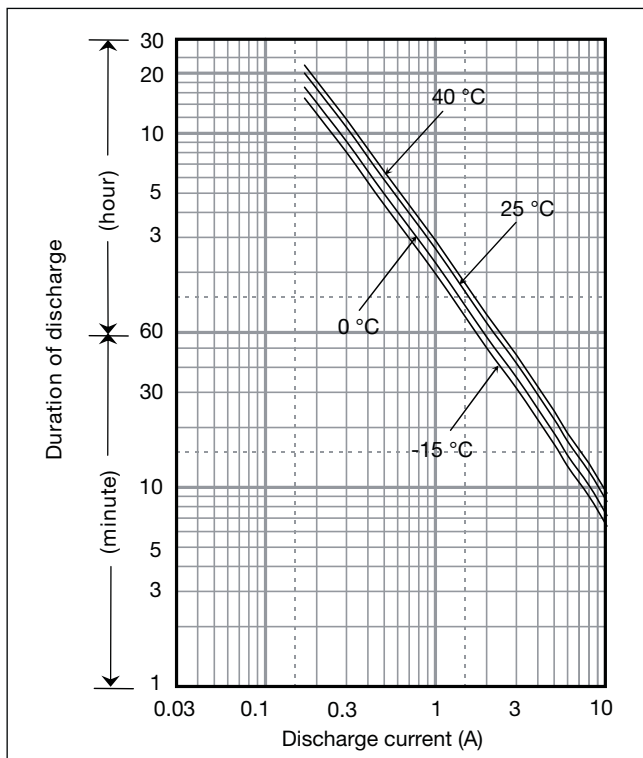

Characteristics

Capacity (25°C)	20 hour rate	3.4Ah
	10 hour rate	3.0Ah
	5 hour rate	2.7Ah
Internal resistance	Fully charged battery (25°C)	60mΩ
	Temperature dependency of capacity (20 hour rate)	40°C: 102% 25°C: 100% 0°C: 85% -15°C: 65%
Self discharge (25°C)	After 3 months	91%
	After 6 months	82%
	After 12 months	64%

Watt Table

Cut-off V	(Wattage/Battery)																
	3min	5min	10min	15min	20min	30min	45min	1h	1.5h	2h	3h	4h	5h	6h	10h	20h	24h
9.6V	204	161	105	80.4	67.4	50.3	35.5	28.4	19.6	15.0	11.3	8.63	7.13	5.80	3.81	2.06	1.72
9.9V	190	151	103	79.8	66.3	49.7	35.3	28.4	19.2	14.9	11.2	8.58	7.07	5.78	3.80	2.05	1.71
10.2V	175	142	100	78.2	65.2	49.2	34.9	27.8	18.8	14.5	11.1	8.52	7.01	5.73	3.76	2.05	1.71
10.5V	155	127	93	72.8	61.9	48.1	34.4	27.3	18.4	14.0	11.0	8.46	6.96	5.66	3.74	2.04	1.70
10.8V	131	112	83	67.9	60.3	46.4	33.8	26.7	17.8	13.4	10.7	8.46	6.79	5.66	3.68	1.98	1.70

Ampere Table

Cut-off V	(Ampere/Battery)																
	3min	5min	10min	15min	20min	30min	45min	1h	1.5h	2h	3h	4h	5h	6h	10h	20h	24h
9.6V	18.4	14.4	9.40	6.99	5.81	4.30	3.02	2.41	1.66	1.26	0.949	0.722	0.595	0.484	0.318	0.171	0.143
9.9V	17.0	13.6	9.21	6.94	5.71	4.25	3.00	2.41	1.62	1.26	0.945	0.718	0.590	0.482	0.316	0.171	0.143
10.2V	15.7	12.7	8.97	6.80	5.62	4.20	2.97	2.36	1.59	1.22	0.935	0.713	0.586	0.478	0.313	0.170	0.142
10.5V	14.0	11.4	8.31	6.33	5.34	4.11	2.93	2.31	1.56	1.18	0.921	0.708	0.581	0.472	0.312	0.170	0.142
10.8V	11.8	10.1	7.41	5.90	5.19	3.97	2.88	2.27	1.51	1.13	0.897	0.708	0.567	0.472	0.307	0.165	0.142

Charging Method

Cycle use	Control voltage: 14.5 - 14.9V; Initial current: 1.36A or smaller
Trickle use	Control voltage: 13.6 - 13.8V; Initial current: 0.51A or smaller

Influence of Temperature on Trickle life

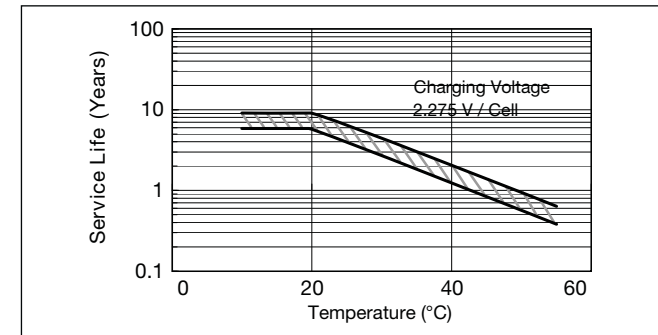

Cut off voltage

Discharge current	0.17A - 0.68A	0.68A - 1.7A	1.7A - 3.4A	3.4A - 6.8A	6.8A - 10.2A
Cut off voltage (V)	10.5	10.2	9.9	9.3	8.7

Cycle life vs Depth of discharge

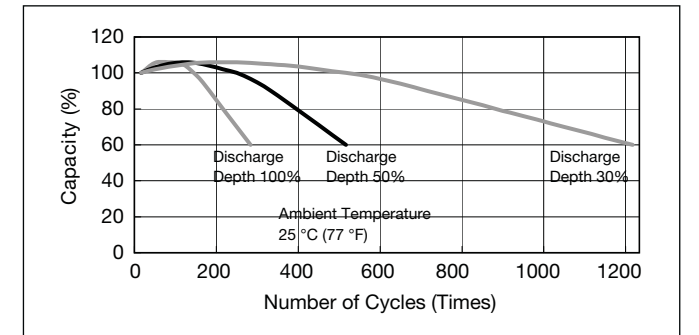

Residual capacity vs storage period

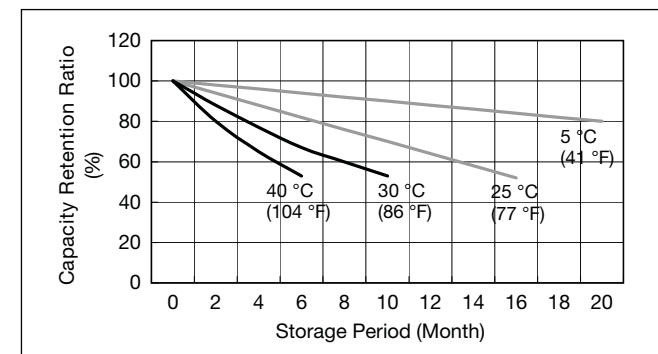

Discharge capacity by temperature and by discharge current

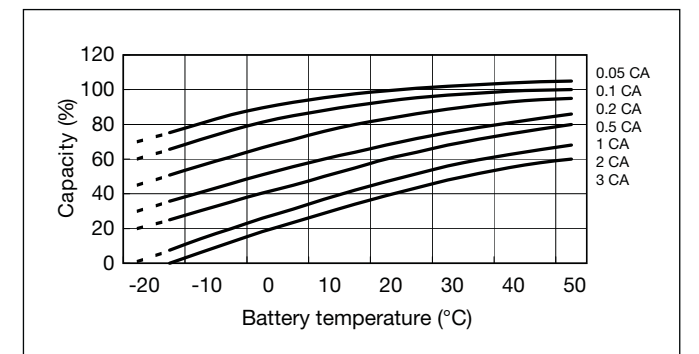

Constant-voltage and constant-current charge characteristics for Trickle use

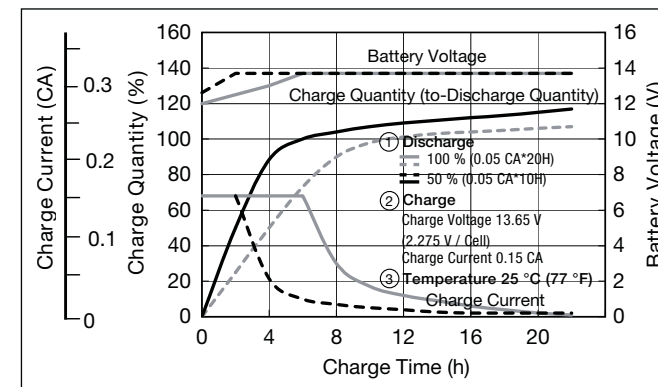

Constant-voltage and constant-current charge characteristics for Cycle use

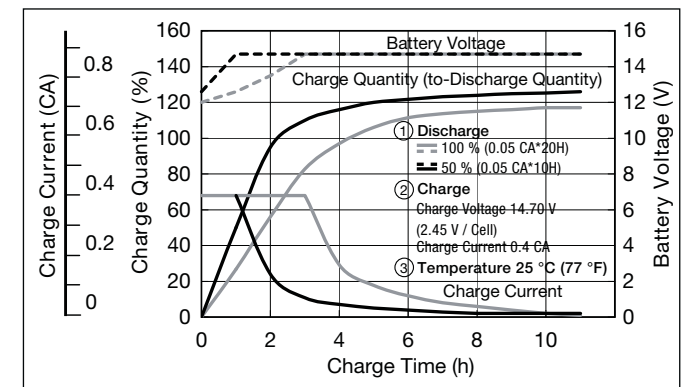

Discharge characteristics

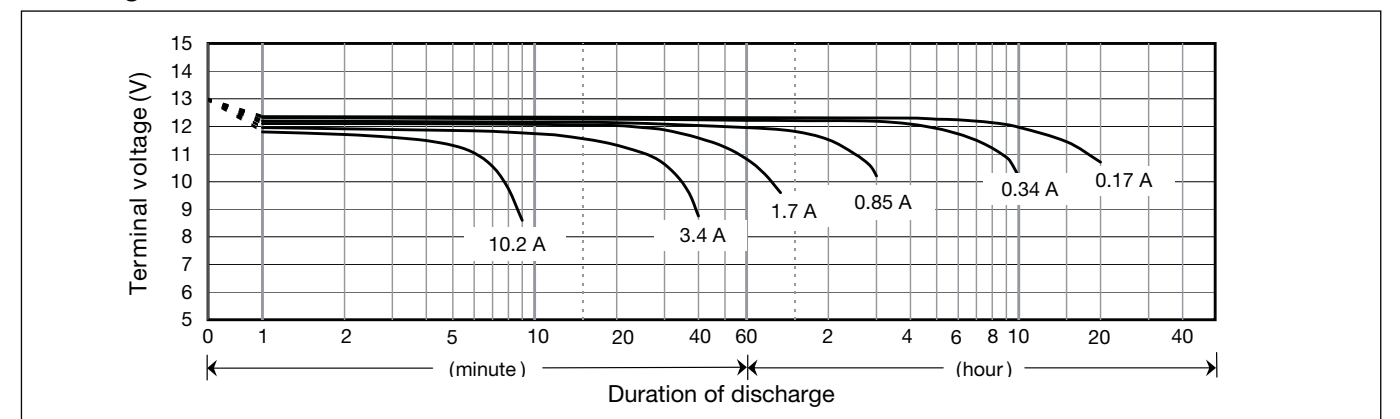

LC-R124R5P

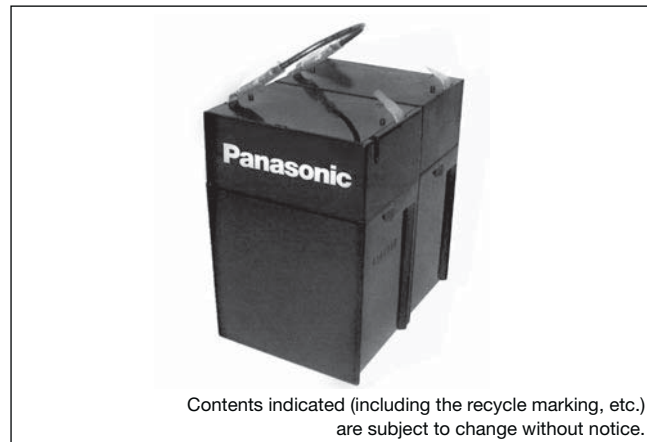

Contents indicated (including the recycle marking, etc.) are subject to change without notice.

For main and standby power supplies.
Expected trickle design life: 6 – 9 years at 20°C according to Eurobat.

Dimensions (mm)

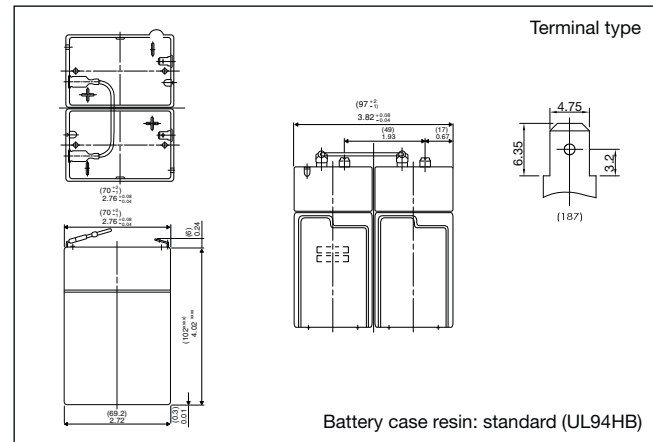

Battery case resin: standard (UL94HB)

Specifications

Nominal voltage	12V	
Nominal capacity (20 hour rate)	4.5Ah	
Dimensions	Length	70mm
	Width	97mm
	Height	102mm
	Total Height	108mm
Approx. mass	1.45kg	
Terminal	Faston 187	

Characteristics

Capacity (25°C)	20 hour rate	4.5Ah
	10 hour rate	3.9Ah
	5 hour rate	3.5Ah
	1 hour rate	2.8Ah
Internal resistance	Fully charged battery (25°C)	40mΩ
Temperature dependency of capacity (20 hour rate)	40°C	102%
	25°C	100%
	0°C	85%
	-15°C	65%
Self discharge (25°C)	After 3 months	91%
	After 6 months	83%
	After 12 months	66%

Duration of discharge vs Discharge current

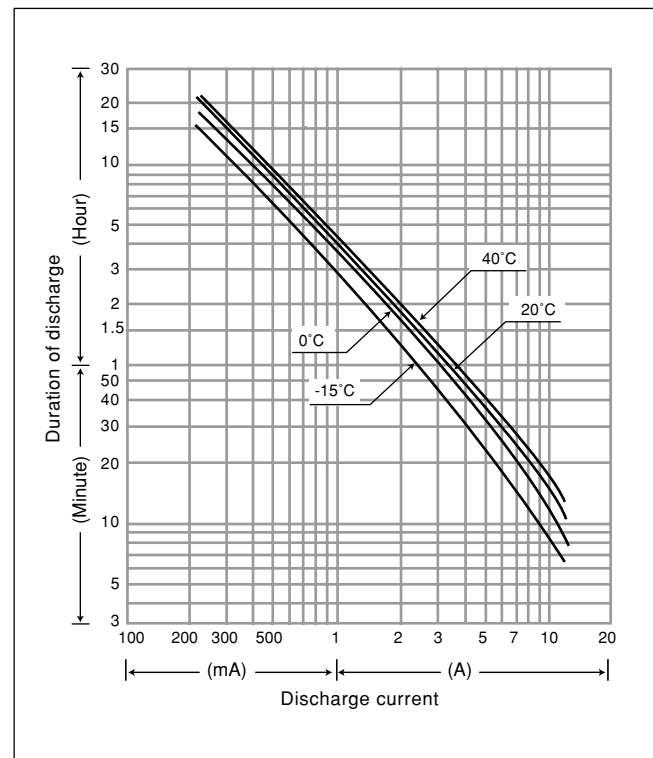

Watt Table

Cut-off V	3min	5min	10min	15min	20min	30min	45min	1h	1.5h	2h	3h	4h	5h	6h	10h	20h	24h
9.6V	270	214	139.4	106.4	89.2	66.6	47	37.6	25.8	19.98	14.88	11.42	9.44	7.58	5.02	2.72	2.272
9.9V	250	200	136.6	105.6	87.8	65.8	46.6	37.6	25.4	19.84	14.8	11.36	9.36	7.56	5	2.72	2.266
10.2V	232	188	133	103.6	86.2	65	46.2	36.8	24.8	19.32	14.66	11.28	9.28	7.5	4.96	2.7	2.258
10.5V	206	168	123.2	96.4	82	63.6	45.4	36	24.2	18.64	14.42	11.2	9.2	7.4	4.92	2.7	2.25
10.8V	174	148	110	89.8	79.8	61.4	44.8	35.4	23.6	17.76	14.14	11.06	8.98	7.28	4.88	2.68	2.236

Ampere Table

Cut-off V	3min	5min	10min	15min	20min	30min	45min	1h	1.5h	2h	3h	4h	5h	6h	10h	20h	24h
9.6V	24.3	19.13	12.44	9.25	7.69	5.69	4.00	3.19	2.19	1.69	1.25	0.956	0.788	0.633	0.419	0.227	0.189
9.9V	22.6	17.94	12.19	9.19	7.56	5.63	3.98	3.19	2.14	1.68	1.24	0.950	0.781	0.630	0.417	0.226	0.189
10.2V	20.8	16.81	11.88	9.00	7.44	5.56	3.94	3.13	2.10	1.63	1.23	0.944	0.775	0.625	0.413	0.226	0.188
10.5V	18.5	15.06	11.00	8.38	7.06	5.44	3.88	3.06	2.06	1.58	1.21	0.938	0.769	0.618	0.411	0.225	0.188
10.8V	15.6	13.31	9.81	7.81	6.88	5.25	3.81	3.00	2.00	1.50	1.19	0.925	0.750	0.608	0.406	0.224	0.186

Charging Method

Trickle use	Control voltage: 13.6 - 13.8V; Initial current: 0,675A or smaller
-------------	---

Influence of Temperature on Trickle life

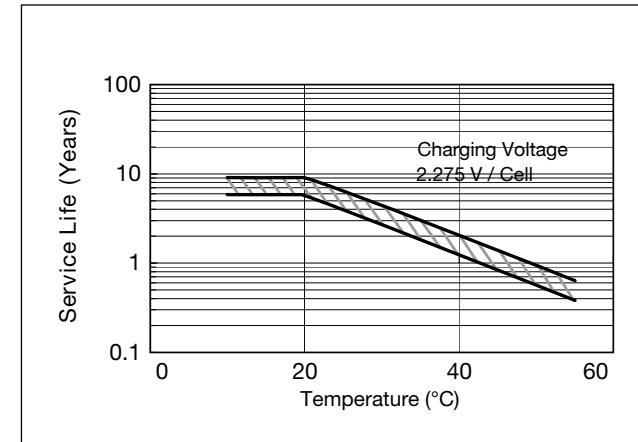

Cut off voltage

Discharge current	0.225 A - 0.9A	0.9A - 2.25A	2.25A - 4.5A	4.5A - 9A	9A - 13.5A
Cut off voltage (V)	10.5	10.2	9.9	9.3	8.7

Residual capacity vs storage period

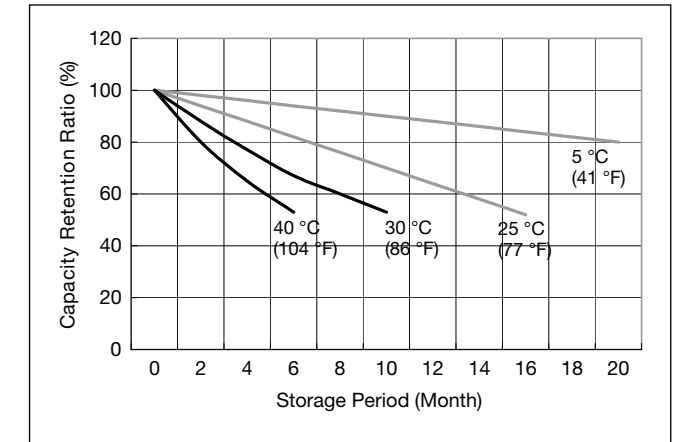

Constant-voltage and constant-current charge characteristics for Trickle use

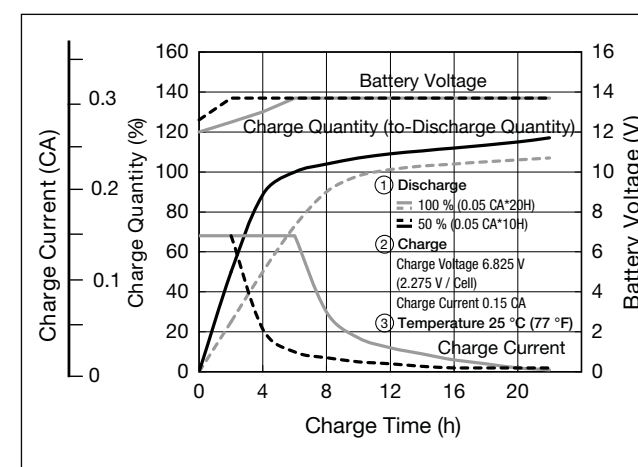

Discharge capacity by temperature and by discharge current

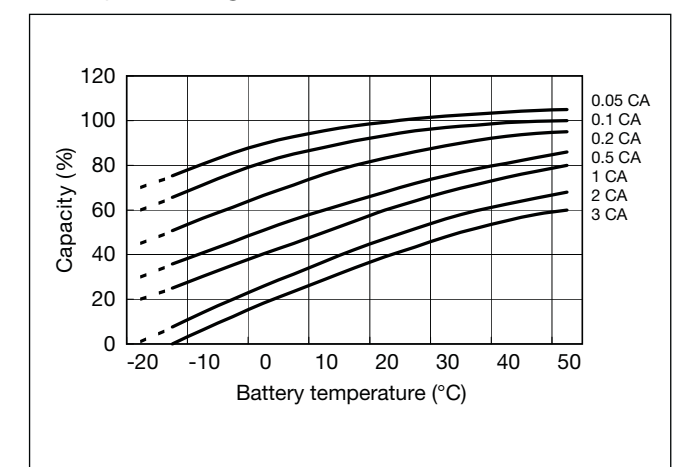

Discharge characteristics

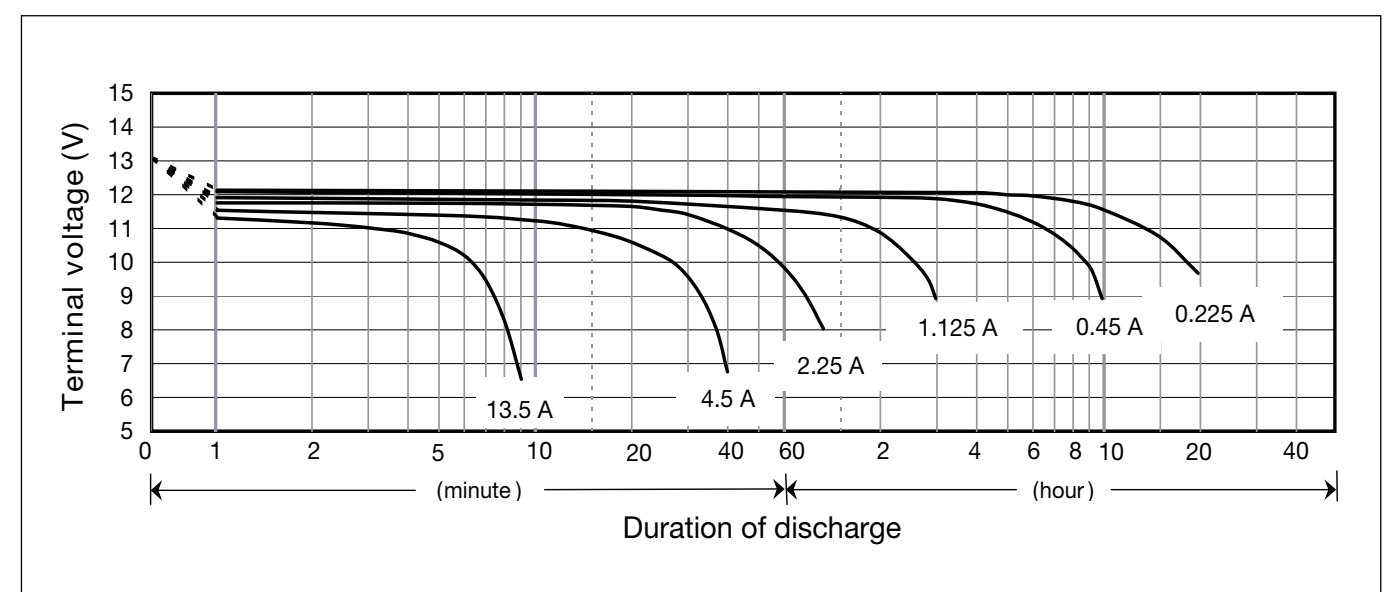

LC-R127R2PG*1

For main and standby power supplies. Expected trickle design life: 6 – 9 years at 20°C according to Eurobat.

VdS

G193046

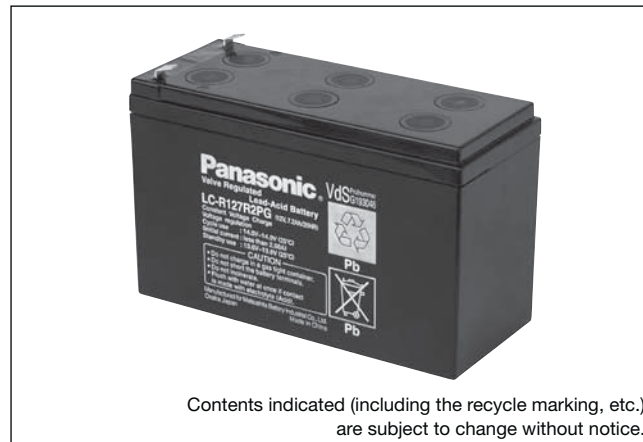

Contents indicated (including the recycle marking, etc.) are subject to change without notice.

Dimensions (mm)

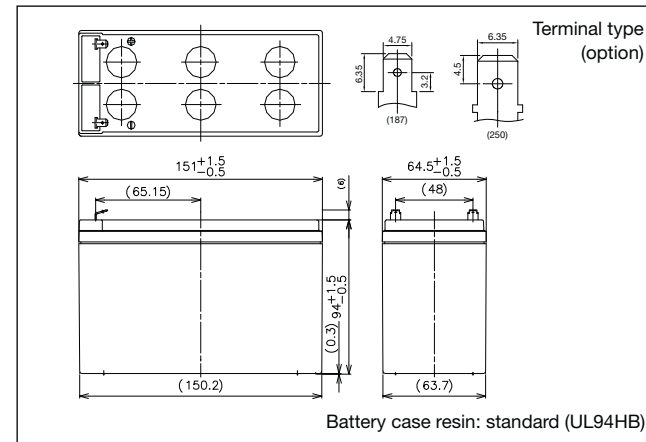

Specifications

Nominal voltage	12V	
Nominal capacity (20 hour rate)	7.2Ah	
Dimensions	Length	151mm
	Width	64.5mm
	Height	94mm
	Total Height	100mm
Approx. mass	2.47kg	
Terminal	Faston 187 or Faston 250 with hole	

Duration of discharge vs Discharge current

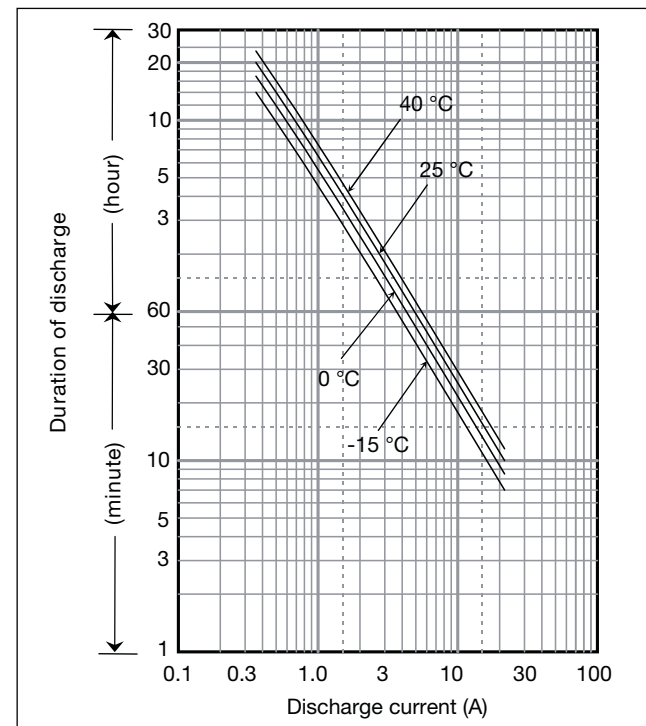

Characteristics

Capacity (25°C)	20 hour rate	7.2Ah
	10 hour rate	6.8Ah
	5 hour rate	6.3Ah
	1 hour rate	4.9Ah
Internal resistance	Fully charged battery (25°C)	21mΩ
Temperature dependency of capacity (20 hour rate)	40°C	102%
	25°C	100%
	0°C	85%
	-15°C	65%
Self discharge (25°C)	After 3 months	91%
	After 6 months	82%
	After 12 months	64%

Watt Table

Cut-off V	(Wattage/Battery)																							
	3min	5min	10min	15min	20min	30min	45min	1h	1.5h	2h	3h	4h	5h	6h	10h	20h	24h							
9.6V	433	341	223	170	143	106	75.1	60.1	41.3	32.0	23.8	18.3	15.1	12.1	8.04	4.36	3.64							
9.9V	401	320	218	169	140	105	74.7	60.1	40.5	31.7	23.7	18.2	15.0	12.1	8.00	4.34	3.62							
10.2V	370	300	213	166	138	104	74.0	58.9	39.7	30.9	23.4	18.0	14.9	12.0	7.92	4.33	3.61							
10.5V	329	269	197	154	131	102	72.8	57.7	38.9	29.8	23.1	17.9	14.7	11.8	7.88	4.32	3.60							
10.8V	278	237	176	144	128	98	71.6	56.5	37.8	28.4	22.6	17.7	14.4	11.7	7.80	4.30	3.58							

Ampere Table

Cut-off V	(Ampere/Battery)																							
	3min	5min	10min	15min	20min	30min	45min	1h	1.5h	2h	3h	4h	5h	6h	10h	20h	24h							
9.6V	38.9	30.6	19.9	14.8	12.3	9.1	6.4	5.1	3.50	2.70	2.00	1.53	1.26	1.012	0.670	0.363	0.303							
9.9V	36.1	28.7	19.5	14.7	12.1	9.0	6.4	5.1	3.43	2.68	1.99	1.52	1.25	1.008	0.667	0.362	0.302							
10.2V	33.3	26.9	19.0	14.4	11.9	8.9	6.3	5.0	3.36	2.61	1.97	1.51	1.24	1.000	0.660	0.361	0.301							
10.5V	29.6	24.1	17.6	13.4	11.3	8.7	6.2	4.9	3.29	2.52	1.94	1.50	1.23	0.988	0.657	0.360	0.300							
10.8V	25.0	21.3	15.7	12.5	11.0	8.4	6.1	4.8	3.20	2.40	1.90	1.48	1.20	0.972	0.650	0.358	0.298							

*1 This battery is also available with a flame retardant battery case resin (UL94 V-0) but with no VdS certification.

Charging Method

Cycle use	Control voltage: 14.5 - 14.9V; Initial current: 2.88A or smaller
Trickle use	Control voltage: 13.6 - 13.8V; Initial current: 1.08A or smaller

Influence of Temperature on Trickle life

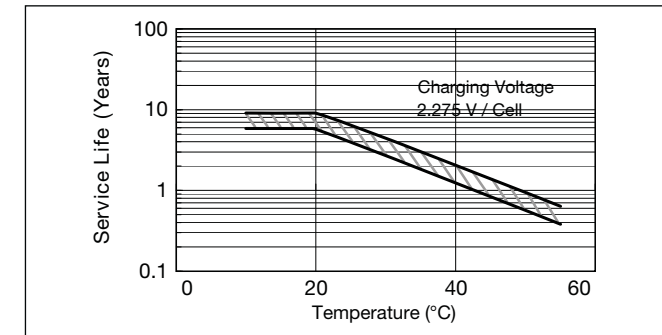

Cut off voltage

Discharge current	0.36A - 1.44A	1.44A - 3.6A	3.6A - 7.2A	7.2A - 14.4A	14.4A - 21.6A
Cut off voltage (V)	10.5	10.2	9.9	9.3	8.7

Cycle life vs Depth of discharge

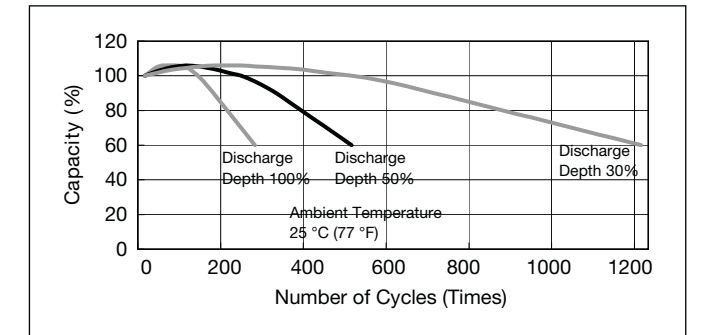

Residual capacity vs storage period

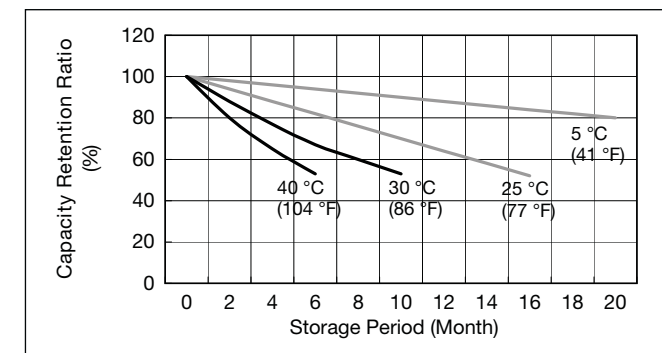

Discharge capacity by temperature and by discharge current

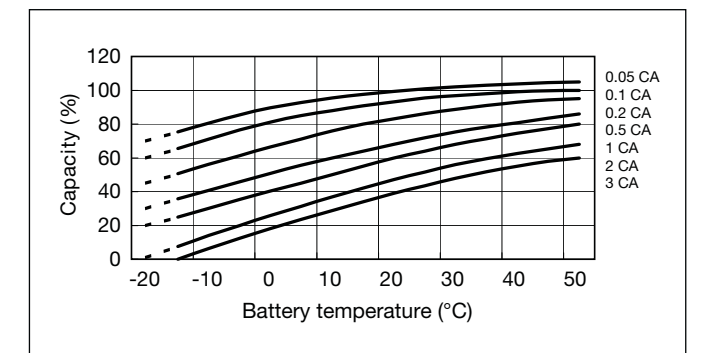

Constant-voltage and constant-current charge characteristics for Trickle use

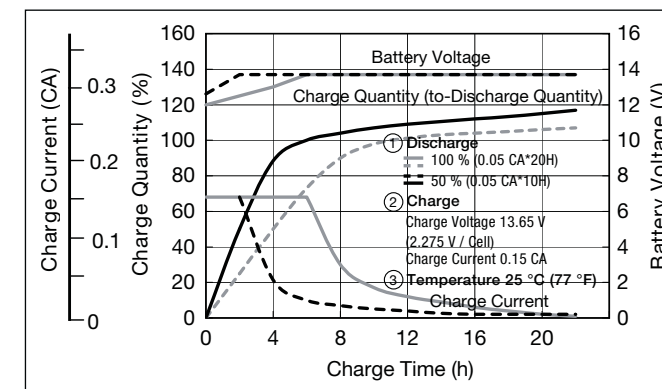

Constant-voltage and constant-current charge characteristics for Cycle use

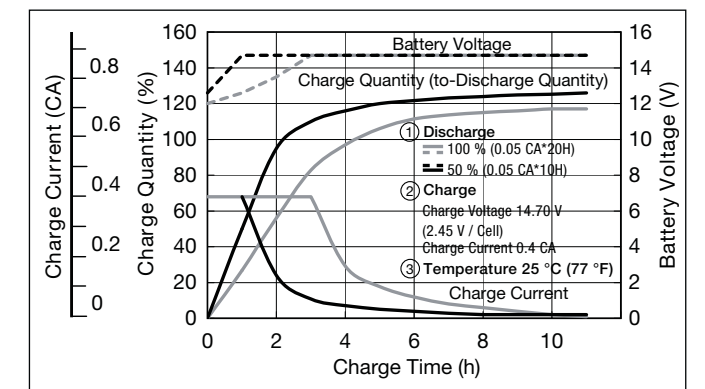

Discharge characteristics

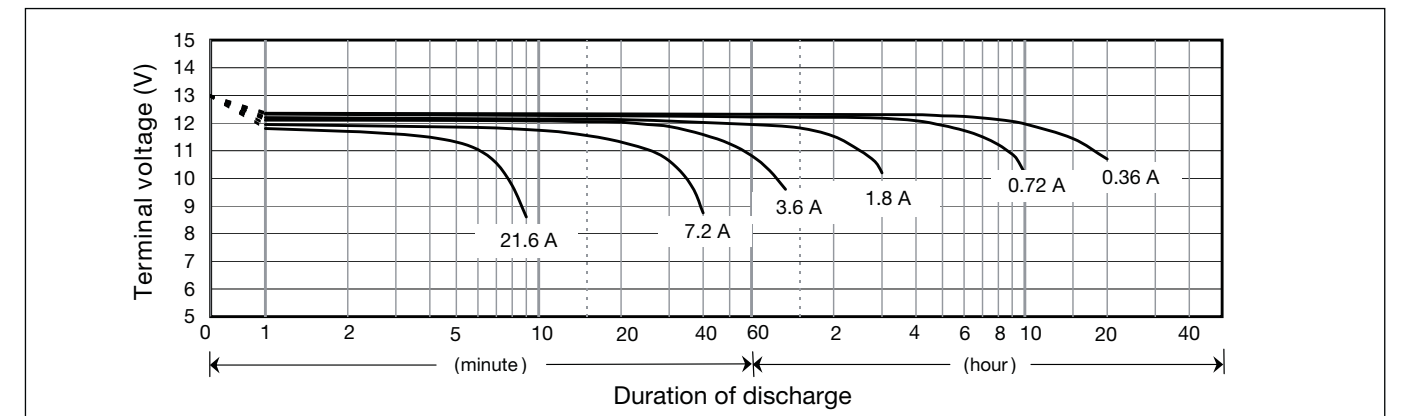

LC-RA1212PG

For main and standby power supplies. Expected trickle design life: 6 – 9 years at 20°C according to Eurobat.

VdS

G100001



Dimensions (mm)

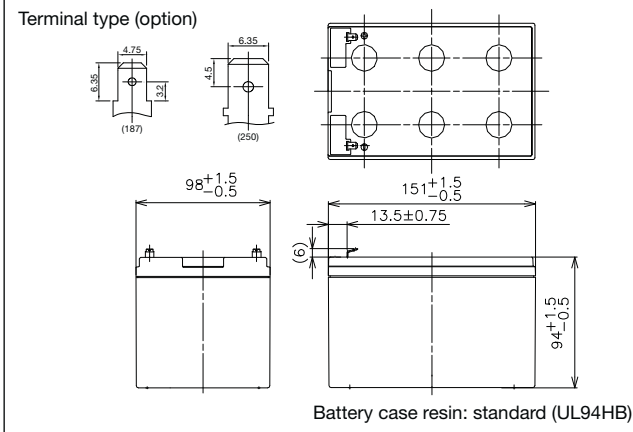

Specifications

Nominal voltage	12V	
Nominal capacity (20 hour rate)	12Ah	
Dimensions	Length	151mm
	Width	98mm
	Height	94mm
	Total Height	100mm
Approx. mass	3.8kg	
Terminal	Faston 187 or Faston 250 with hole	

Duration of discharge vs Discharge current

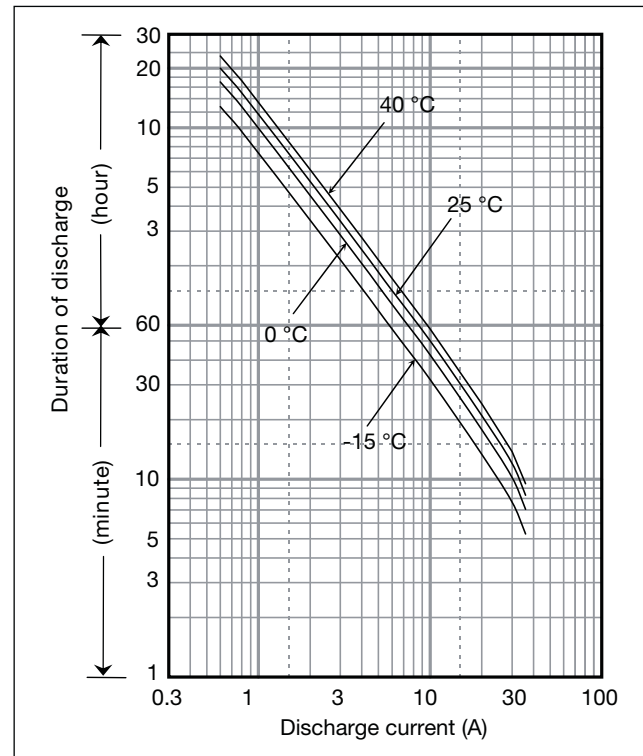

Characteristics

Capacity (25°C)	20 hour rate	12.0Ah
	10 hour rate	11.3Ah
	5 hour rate	10.4Ah
Internal resistance	Fully charged battery (25°C)	30mΩ
	1 hour rate	8.1Ah
Temperature dependency of capacity (20 hour rate)	40°C	102%
	25°C	100%
	0°C	85%
	-15°C	65%
Self discharge (25°C)	After 3 months	91%
	After 6 months	82%
	After 12 months	64%

Watt Table

Cut-off V	(Wattage/Battery)																							
	3min	5min	10min	15min	20min	30min	45min	1h	1.5h	2h	3h	4h	5h	6h	10h	20h	24h							
9.6V	679	559	384	298	247	183	137	105	70.3	54.5	38.1	28.8	24.1	21.7	13.3	7.22	6.02							
9.9V	649	537	373	288	241	177	135	104	69.9	54.2	37.8	28.8	24.1	21.7	13.3	7.22	6.02							
10.2V	607	506	363	282	235	177	134	102	69.1	53.9	37.5	28.8	24.0	21.6	13.2	7.21	6.01							
10.5V	556	475	343	271	231	172	133	100	68.5	53.3	36.9	28.7	24.0	21.6	13.2	7.20	6.00							
10.8V	495	434	321	261	225	166	123	98	66.1	52.1	36.3	28.4	23.8	21.5	13.1	7.18	5.98							

Ampere Table

Cut-off V	(Ampere/Battery)																							
	3min	5min	10min	15min	20min	30min	45min	1h	1.5h	2h	3h	4h	5h	6h	10h	20h	24h							
9.6V	61.1	50.1	34.3	25.9	21.3	15.6	11.7	8.90	5.95	4.60	3.20	2.41	2.01	1.81	1.11	0.602	0.502							
9.9V	58.4	48.2	33.3	25.0	20.8	15.1	11.5	8.80	5.92	4.58	3.18	2.41	2.01	1.81	1.11	0.602	0.502							
10.2V	54.6	45.4	32.4	24.5	20.3	15.1	11.4	8.70	5.85	4.55	3.15	2.41	2.00	1.80	1.10	0.601	0.501							
10.5V	50.0	42.6	30.6	23.6	19.9	14.7	11.3	8.50	5.80	4.50	3.10	2.40	2.00	1.80	1.10	0.600	0.500							
10.8V	44.5	38.9	28.7	22.7	19.4	14.2	10.5	8.30	5.60	4.40	3.05	2.38	1.99	1.79	1.09	0.598	0.498							

Charging Method

Cycle use	Control voltage: 14.5 - 14.9V; Initial current: 4.8A or smaller
Trickle use	Control voltage: 13.6 - 13.8V; Initial current: 1.8A or smaller

Influence of Temperature on Trickle life

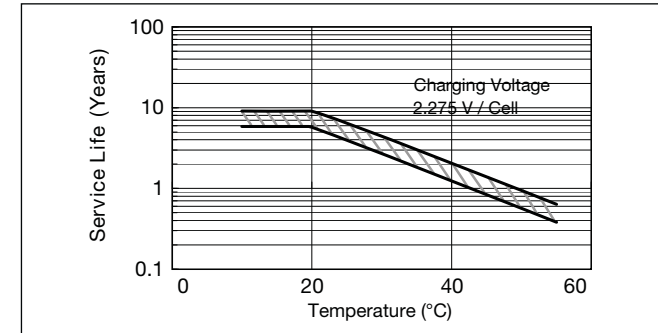

Cut off voltage

Discharge current	0.6A - 2.4A	2.4A - 6A	6A - 12A	12A - 24A	24A - 36A
Cut off voltage (V)	10.5	10.2	9.9	9.3	8.7

Cycle life vs Depth of discharge

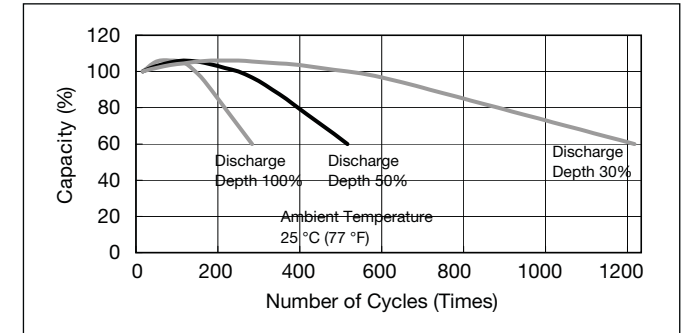

Residual capacity vs storage period

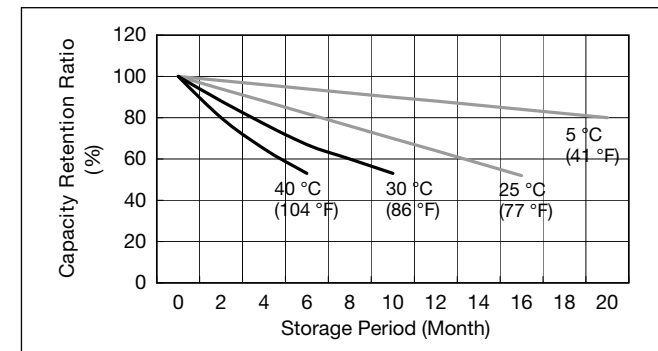

Discharge capacity by temperature and by discharge current

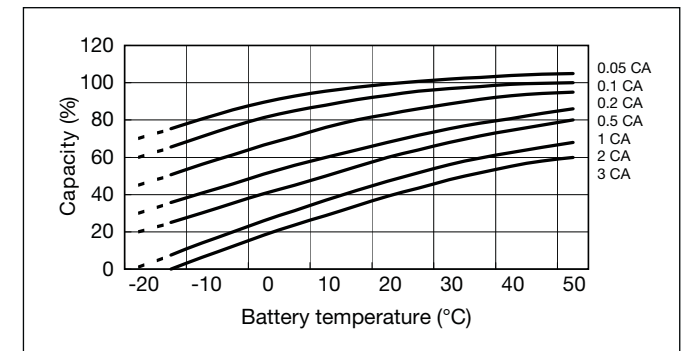

Constant-voltage and constant-current charge characteristics for Trickle use

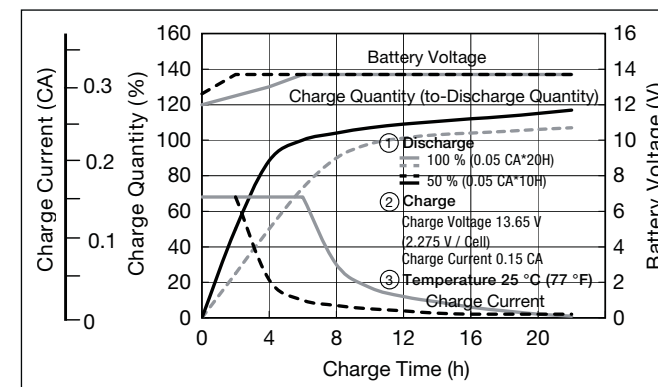

Constant-voltage and constant-current charge characteristics for Cycle use

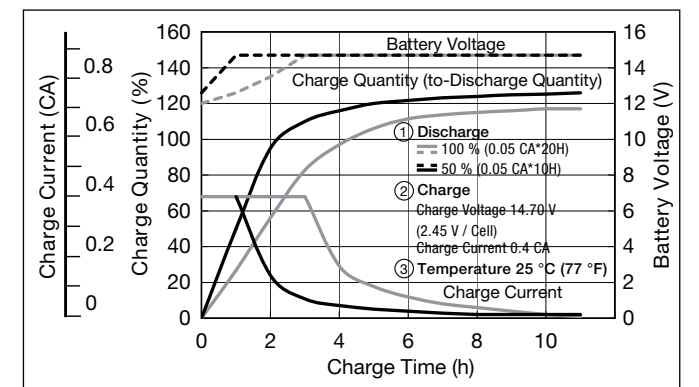

Discharge characteristics

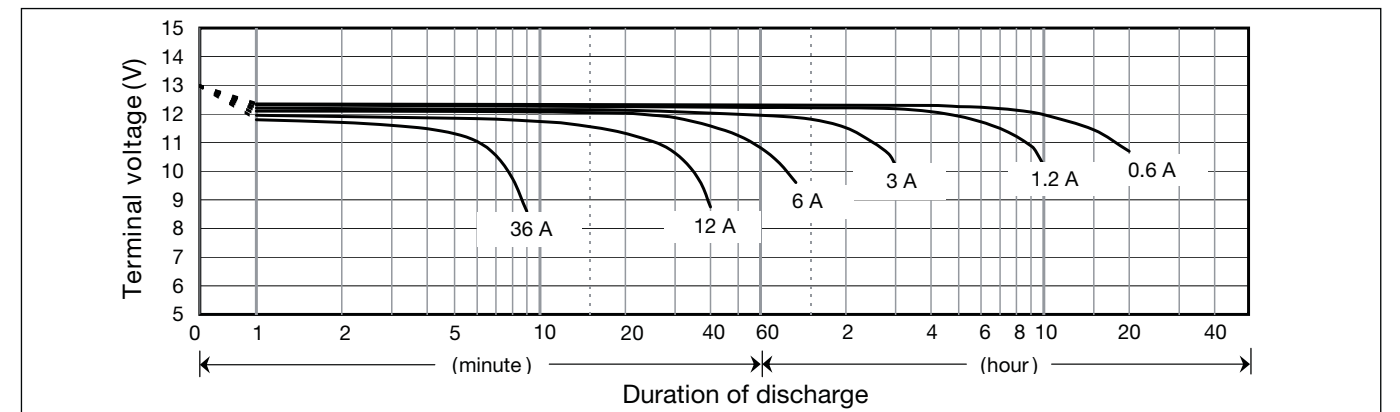

LC-RA1215P



For main and standby power supplies.
Expected trickle design life: 6 – 9 years at 20°C according to Eurobat.

Dimensions (mm)

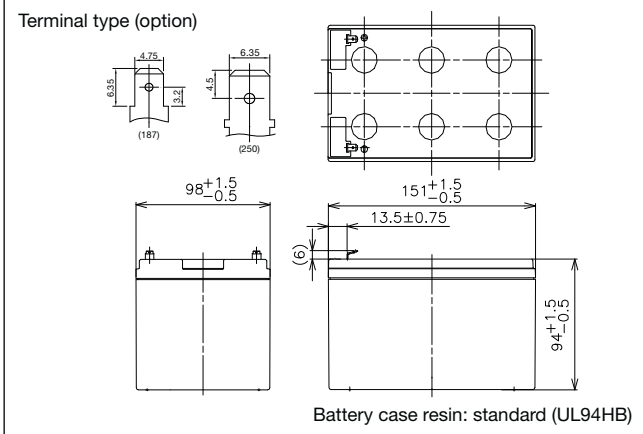

Specifications

Nominal voltage	12V	
Nominal capacity (20 hour rate)	15Ah	
Dimensions	Length	151mm
	Width	98mm
	Height	94mm
	Total Height	100mm
Approx. mass	4.2kg	
Terminal	Faston 187 or Faston 250 with hole	

Duration of discharge vs Discharge current

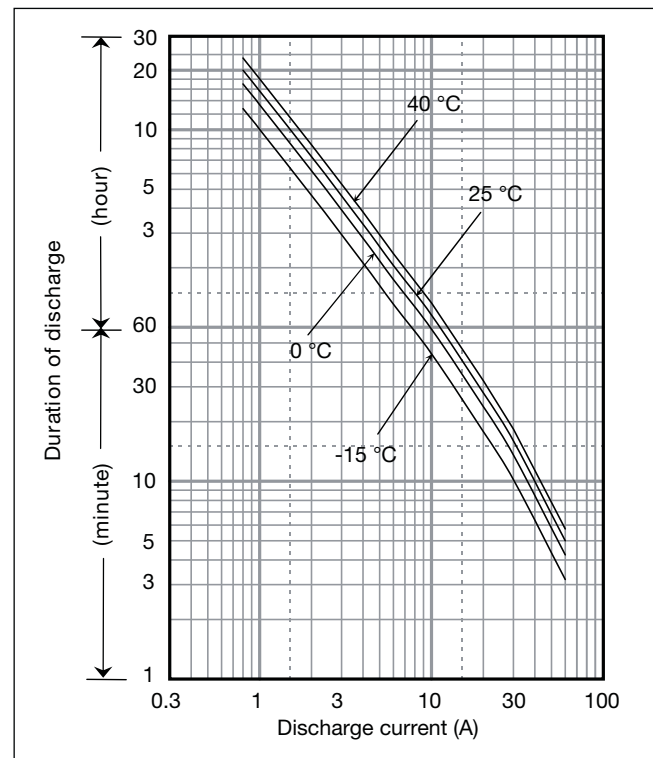

Characteristics

Capacity (25°C)	20 hour rate	15.0Ah
	10 hour rate	14.0Ah
	5 hour rate	12.9Ah
	1 hour rate	10.0Ah
Internal resistance	Fully charged battery (25°C)	30mΩ
Temperature dependency of capacity (20 hour rate)	40°C	102%
	25°C	100%
	0°C	85%
	-15°C	65%
Self discharge (25°C)	After 3 months	91%
	After 6 months	82%
	After 12 months	64%

Watt Table

Cut-off V	(Wattage/Battery)																
	3min	5min	10min	15min	20min	30min	45min	1h	1.5h	2h	3h	4h	5h	6h	10h	20h	24h
9.6V	850	682	455	350	292	217	157	123	83.9	65.0	47.1	36.0	29.9	25.2	16.2	8.75	7.30
9.9V	799	646	444	343	286	213	156	123	82.8	64.6	46.9	35.8	29.7	25.1	16.1	8.74	7.29
10.2V	741	607	433	336	281	211	154	121	81.4	63.4	46.4	35.7	29.5	24.9	15.9	8.72	7.27
10.5V	667	555	404	318	270	206	152	118	80.1	61.9	45.7	35.5	29.4	24.8	15.9	8.70	7.25
10.8V	576	497	368	300	263	199	146	116	77.7	59.6	44.8	35.1	28.9	24.5	15.7	8.66	7.21

Ampere Table

Cut-off V	(Ampere/Battery)																
	3min	5min	10min	15min	20min	30min	45min	1h	1.5h	2h	3h	4h	5h	6h	10h	20h	24h
9.6V	76.5	61.2	40.6	30.4	25.2	18.5	13.4	10.5	7.11	5.49	3.96	3.01	2.49	2.10	1.35	0.730	0.609
9.9V	71.8	58.0	39.7	29.9	24.7	18.2	13.3	10.4	7.01	5.45	3.94	3.00	2.48	2.09	1.34	0.728	0.608
10.2V	66.6	54.5	38.6	29.2	24.2	18.1	13.1	10.3	6.89	5.36	3.90	2.99	2.46	2.08	1.33	0.727	0.606
10.5V	59.9	49.8	36.1	27.6	23.3	17.6	13.0	10.0	6.78	5.22	3.84	2.97	2.45	2.07	1.33	0.725	0.604
10.8V	51.8	44.6	32.9	26.1	22.7	17.0	12.5	9.82	6.58	5.03	3.77	2.94	2.41	2.04	1.31	0.722	0.601

Charging Method

Cycle use	Control voltage: 14.5 - 14.9V; Initial current: 6A or smaller
Trickle use	Control voltage: 13.6 - 13.8V; Initial current: 2.25A or smaller

Influence of Temperature on Trickle life

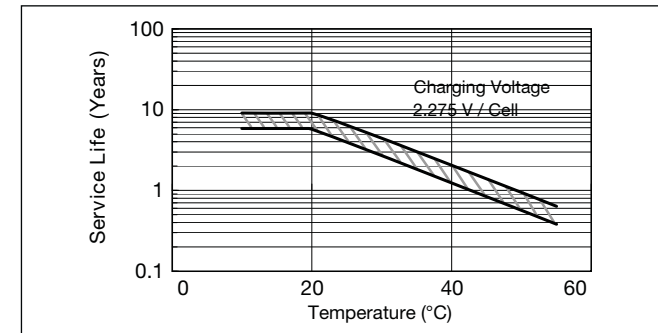

Cut off voltage

Discharge current	0.75A - 3A	3A - 7.5A	7.5A - 15A	15A - 30A	30A - 45A
Cut off voltage (V)	10.5	10.2	9.9	9.3	8.7

Cycle life vs Depth of discharge

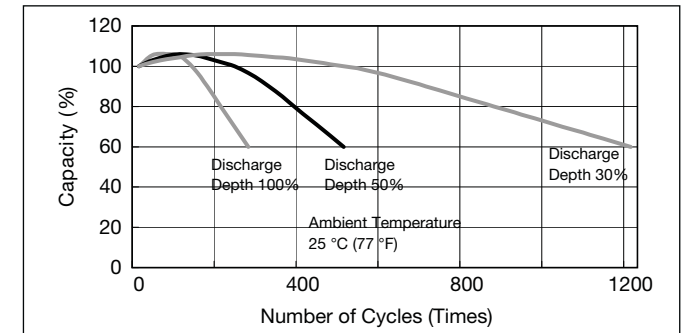

Residual capacity vs storage period

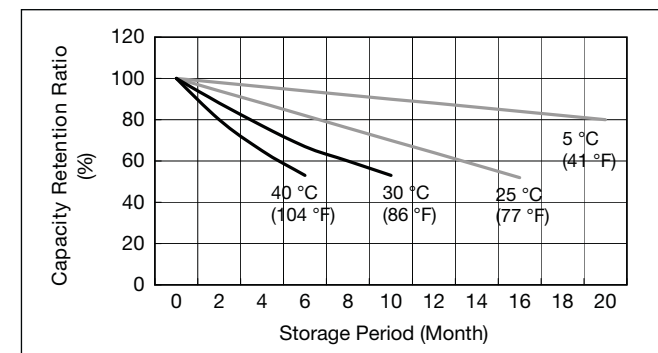

Discharge capacity by temperature and by discharge current

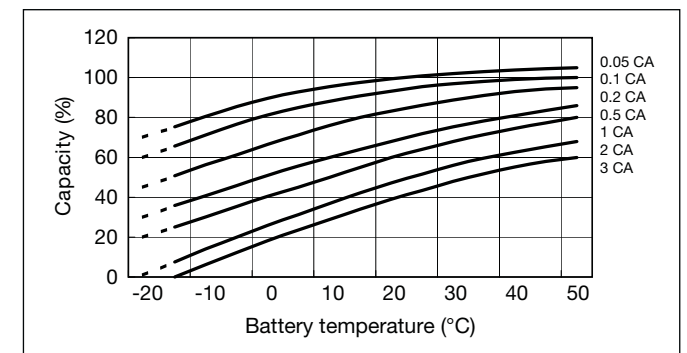

Constant-voltage and constant-current charge characteristics for Trickle use

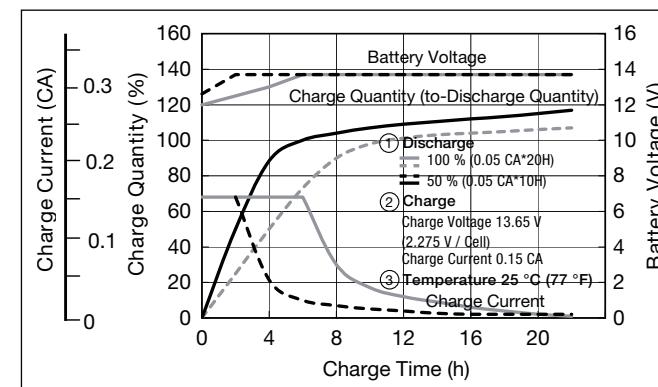

Constant-voltage and constant-current charge characteristics for Cycle use

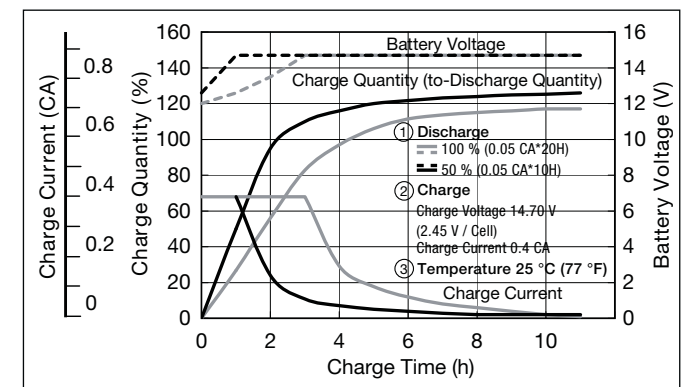

Discharge characteristics

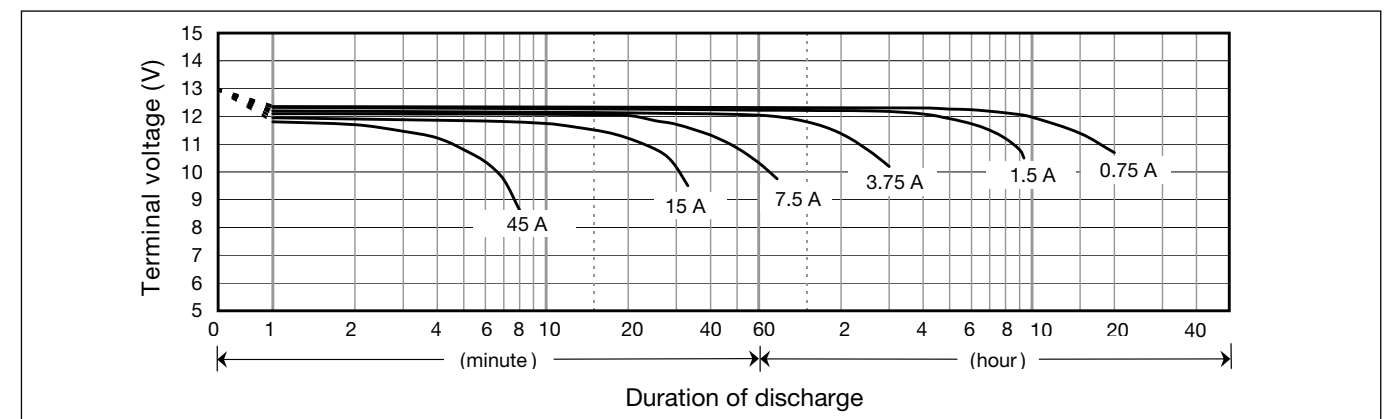

LC-R1233P



Contents indicated (including the recycle marking, etc.) are subject to change without notice.

For main and standby power supplies.
Expected trickle design life: 6 – 9 years at 20°C according to Eurobat.

Dimensions (mm)

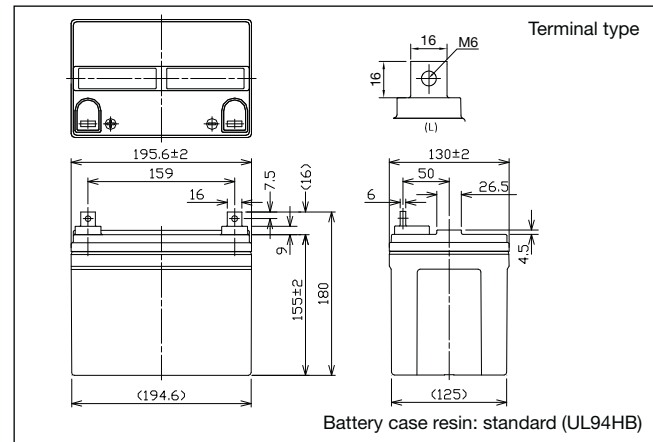

Specifications

Nominal voltage	12V	
Nominal capacity (20 hour rate)	33Ah	
Dimensions	Length	195.6mm
	Width	130mm
	Height	155mm
	Total Height	180mm
Approx. mass	12kg	
Terminal	M6 Bolt and Nut type	

Duration of discharge vs Discharge current

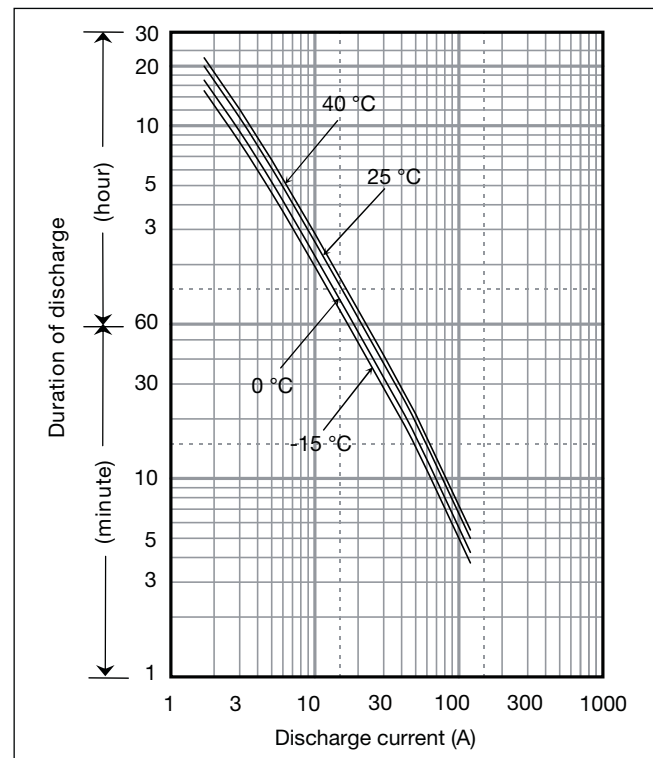

Characteristics

Capacity (25°C)	20 hour rate 10 hour rate 5 hour rate 1 hour rate	33Ah 30Ah 27Ah 20Ah
Internal resistance	Fully charged battery (25°C)	7mΩ
Temperature dependency of capacity (20 hour rate)	40°C 25°C 0°C -15°C	102% 100% 85% 65%
Self discharge (25°C)	After 3 months After 6 months After 12 months	91% 82% 64%

Watt Table

Cut-off V	(Wattage/Battery)																	
	3min	5min	10min	15min	20min	30min	45min	1h	1.5h	2h	3h	4h	5h	6h	10h	20h	24h	
9.6V	1546	1254	948	732	635	457	328	268	187	149	107	86.6	69.5	60.5	36.9	19.8	16.5	
9.9V	1446	1182	928	721	630	452	322	262	182	148	105	85.4	68.3	60.0	36.9	19.8	16.5	
10.2V	1379	1115	899	706	619	443	321	259	170	147	104	84.2	67.7	60.0	36.9	19.8	16.5	
10.5V	1323	1051	868	684	603	433	314	256	168	146	104	84.2	67.7	60.0	36.9	19.8	16.5	
10.8V	1182	1001	823	663	590	421	281	233	162	137	99	82.5	67.1	58.8	36.9	19.8	16.3	

Ampere Table

Cut-off V	(Ampere/Battery)																	
	3min	5min	10min	15min	20min	30min	45min	1h	1.5h	2h	3h	4h	5h	6h	10h	20h	24h	
9.6V	139	113	84.6	63.7	54.8	39.1	27.9	22.8	15.8	12.6	9.00	7.25	5.80	5.10	3.08	1.65	1.38	
9.9V	130	106	82.9	62.7	54.4	38.6	27.4	22.2	15.5	12.5	8.85	7.15	5.70	5.00	3.08	1.65	1.38	
10.2V	124	100	80.3	61.4	53.4	37.9	27.4	22.0	14.4	12.4	8.75	7.05	5.65	5.00	3.08	1.65	1.38	
10.5V	119	94	77.5	59.5	52.0	37.0	26.8	21.8	14.3	12.3	8.70	7.05	5.65	5.00	3.08	1.65	1.38	
10.8V	106	90	73.5	57.7	50.9	36.0	24.0	19.8	13.7	11.6	8.35	6.90	5.60	4.90	3.08	1.65	1.36	

Charging Method

Cycle use	Control voltage: 14.5 - 14.9V; Initial current: 13.2A or smaller
Trickle use	Control voltage: 13.6 - 13.8V; Initial current: 4.95A or smaller

Influence of Temperature on Trickle life

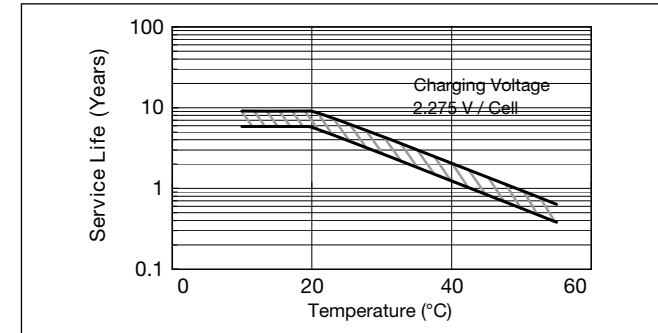

Cut off voltage

Discharge current	1.65A - 6.6A	6.6A - 16.5A	16.5A - 33A	33A - 66A	66A - 99A
Cut off voltage (V)	10.5	10.2	9.9	9.3	8.7

Cycle life vs Depth of discharge

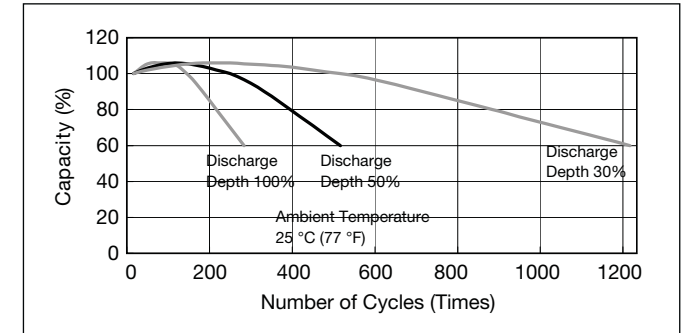

Residual capacity vs storage period

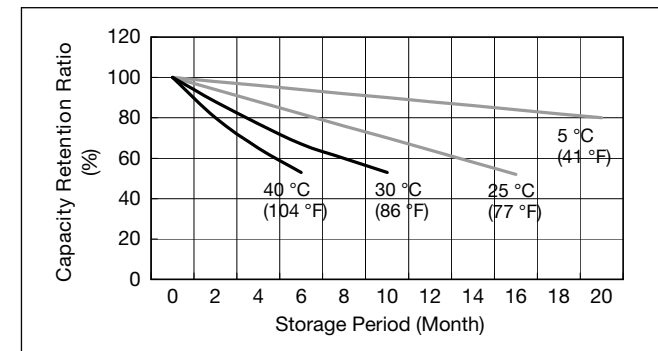

Discharge capacity by temperature and by discharge current

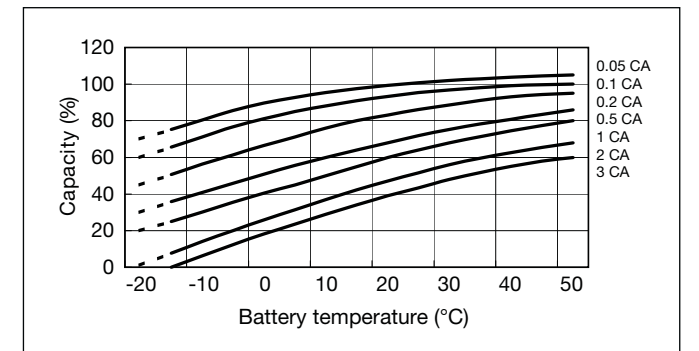

Constant-voltage and constant-current charge characteristics for Trickle use

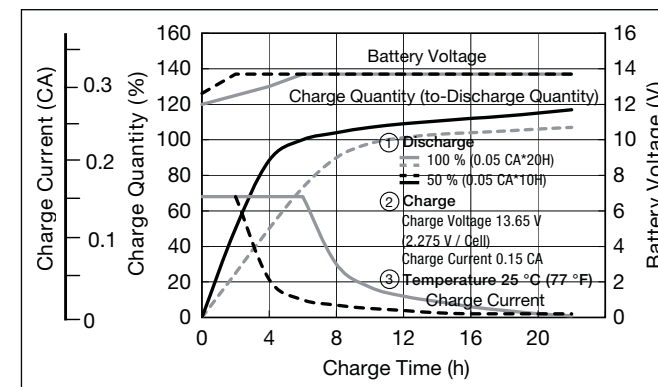

Constant-voltage and constant-current charge characteristics for Cycle use

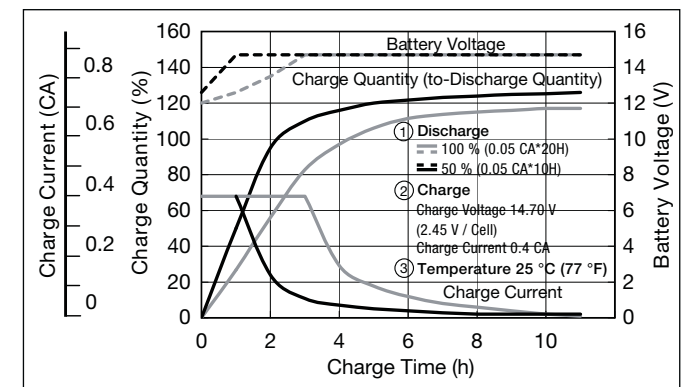

Discharge characteristics

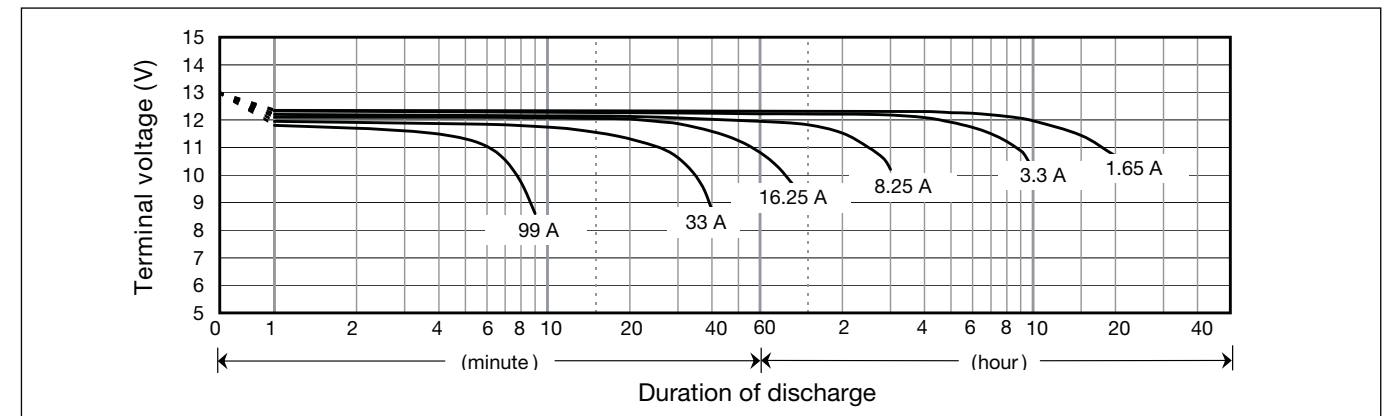

LC-V1233P

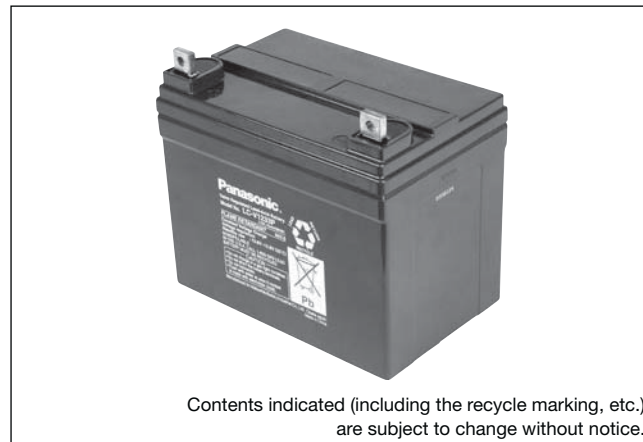

Contents indicated (including the recycle marking, etc.) are subject to change without notice.

For main and standby power supplies.
Expected trickle design life: 6 – 9 years at 20°C according to Eurobat.

Dimensions (mm)

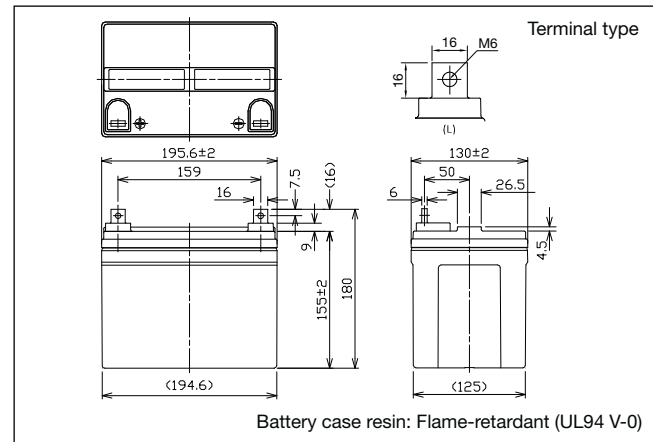

Specifications

Nominal voltage	12V	
Nominal capacity (20 hour rate)	33Ah	
Dimensions	Length	195.6mm
	Width	130mm
	Height	155mm
	Total Height	180mm
Approx. mass	11.1kg	
Terminal	M6 Bolt and Nut type	

Duration of discharge vs Discharge current

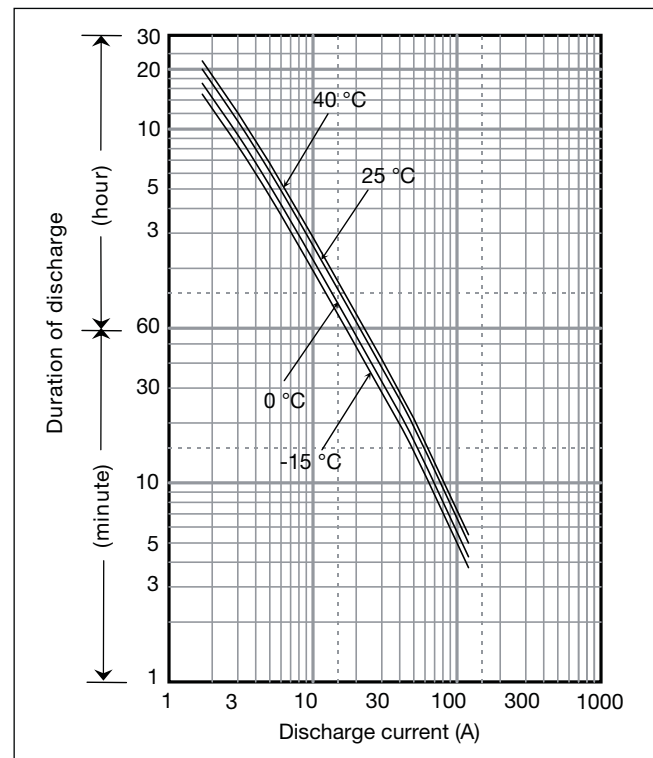

Characteristics

Capacity (25°C)	20 hour rate 10 hour rate 5 hour rate 1 hour rate	33Ah 30Ah 27Ah 20Ah
Internal resistance	Fully charged battery (25°C)	7mΩ
Temperature dependency of capacity (20 hour rate)	40°C 25°C 0°C -15°C	102% 100% 85% 65%
Self discharge (25°C)	After 3 months After 6 months After 12 months	91% 82% 64%

Watt Table

Cut-off V	(Wattage/Battery)																		
	3min	5min	10min	15min	20min	30min	45min	1h	1.5h	2h	3h	4h	5h	6h	10h	20h	24h		
9.6V	1546	1254	948	732	635	457	328	268	187	149	107	86.6	69.5	60.5	36.9	19.8	16.5		
9.9V	1446	1182	928	721	630	452	322	262	182	148	105	85.4	68.3	60.0	36.9	19.8	16.5		
10.2V	1379	1115	899	706	619	443	321	259	170	147	104	84.2	67.7	60.0	36.9	19.8	16.5		
10.5V	1323	1051	868	684	603	433	314	256	168	146	104	84.2	67.7	60.0	36.9	19.8	16.5		
10.8V	1182	1001	823	663	590	421	281	233	162	137	99	82.5	67.1	58.8	36.9	19.8	16.3		

Ampere Table

Cut-off V	(Ampere/Battery)																		
	3min	5min	10min	15min	20min	30min	45min	1h	1.5h	2h	3h	4h	5h	6h	10h	20h	24h		
9.6V	139	113	84.6	63.7	54.8	39.1	27.9	22.8	15.8	12.6	9.00	7.25	5.80	5.10	3.08	1.65	1.38		
9.9V	130	106	82.9	62.7	54.4	38.6	27.4	22.2	15.5	12.5	8.85	7.15	5.70	5.00	3.08	1.65	1.38		
10.2V	124	100	80.3	61.4	53.4	37.9	27.4	22.0	14.4	12.4	8.75	7.05	5.65	5.00	3.08	1.65	1.38		
10.5V	119	94	77.5	59.5	52.0	37.0	26.8	21.8	14.3	12.3	8.70	7.05	5.65	5.00	3.08	1.65	1.38		
10.8V	106	90	73.5	57.7	50.9	36.0	24.0	19.8	13.7	11.6	8.35	6.90	5.60	4.90	3.08	1.65	1.36		

Charging Method

Cycle use	Control voltage: 14.5 - 14.9V; Initial current: 13.2A or smaller
Trickle use	Control voltage: 13.6 - 13.8V; Initial current: 4.95A or smaller

Influence of Temperature on Trickle life

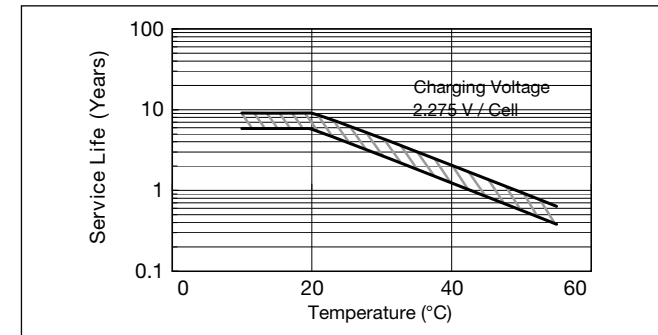

Cut off voltage

Discharge current	1.65A - 6.6A	6.6A - 16.5A	16.5A - 33A	33A - 66A	66A - 99A
Cut off voltage (V)	10.5	10.2	9.9	9.3	8.7

Cycle life vs Depth of discharge

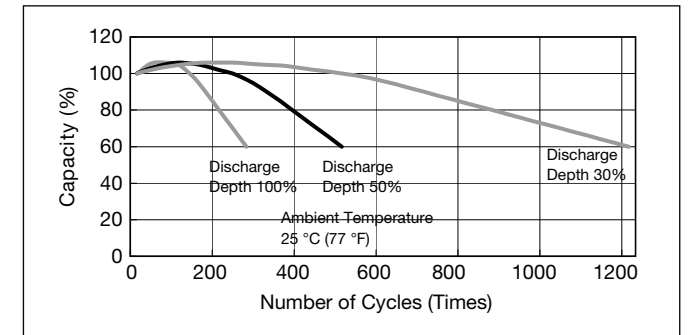

Residual capacity vs storage period

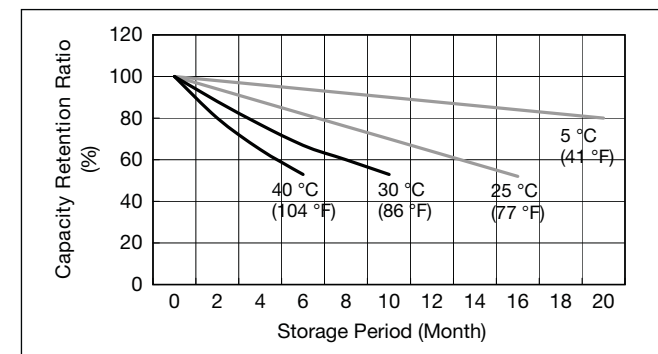

Discharge capacity by temperature and by discharge current

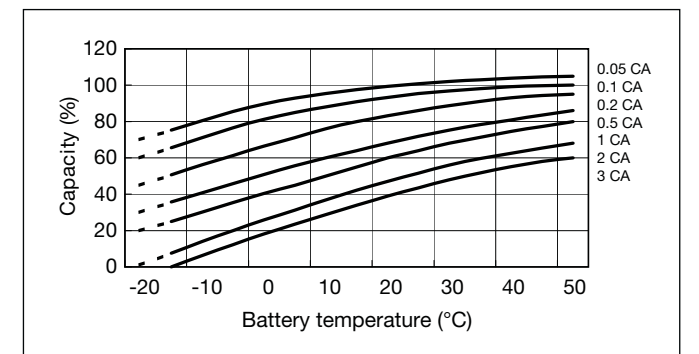

Constant-voltage and constant-current charge characteristics for Trickle use

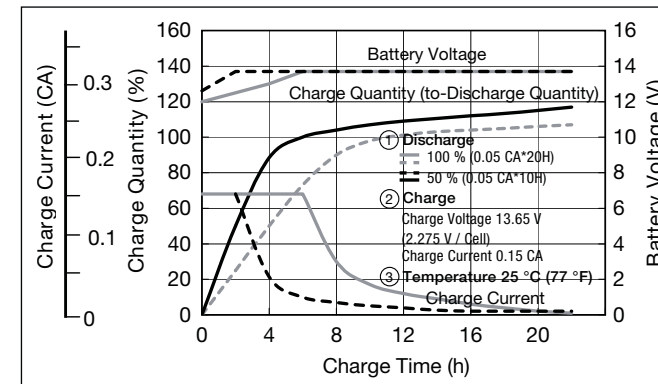

Constant-voltage and constant-current charge characteristics for Cycle use

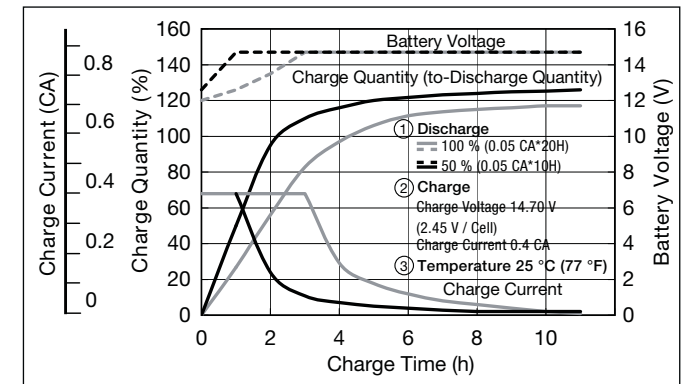

Discharge characteristics

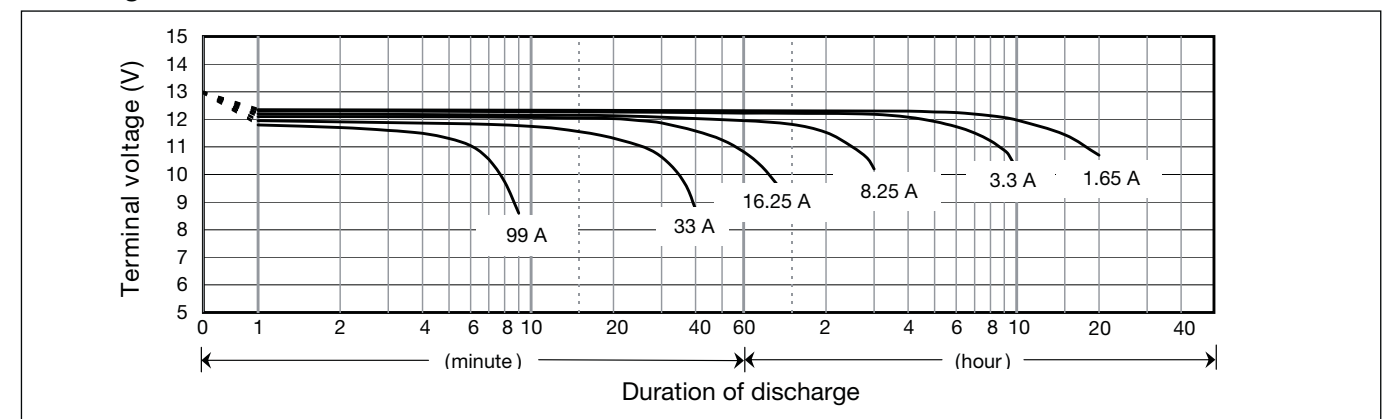

LC-P067R2P

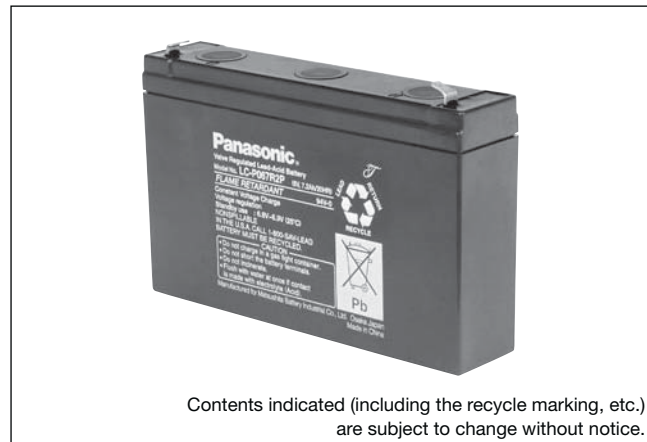

Contents indicated (including the recycle marking, etc.) are subject to change without notice.

For standby power supplies.
Expected trickle design life: 10 – 12 years at 20°C according to Eurobat.

Dimensions (mm)

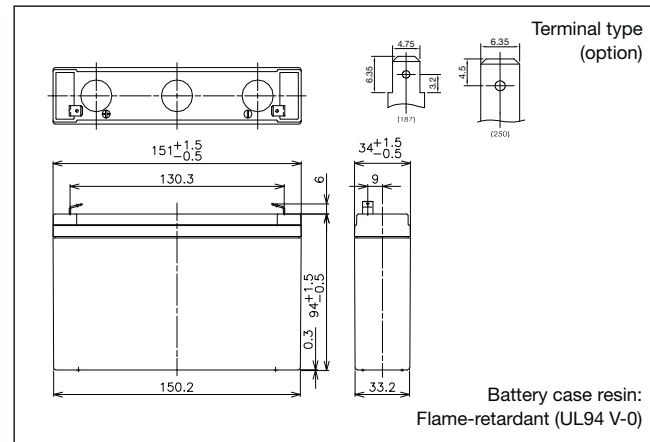

Battery case resin:
Flame-retardant (UL94 V-0)

Specifications

Nominal voltage	6V	
Nominal capacity (20 hour rate)	7.2Ah	
Dimensions	Length	151mm
	Width	34mm
	Height	94mm
	Total Height	100mm
Approx. mass	1.30kg	
Terminal	Faston 187 or Faston 250 with hole	

Characteristics

Capacity (25°C)	20 hour rate 10 hour rate 5 hour rate 1 hour rate	7.2Ah 6.8Ah 6.3Ah 4.9Ah
Internal resistance	Fully charged battery (25°C)	11mΩ
Temperature dependency of capacity (20 hour rate)	40°C 25°C 0°C -15°C	102% 100% 85% 65%
Self discharge (25°C)	After 3 months After 6 months After 12 months	91% 82% 64%

Duration of discharge vs Discharge current

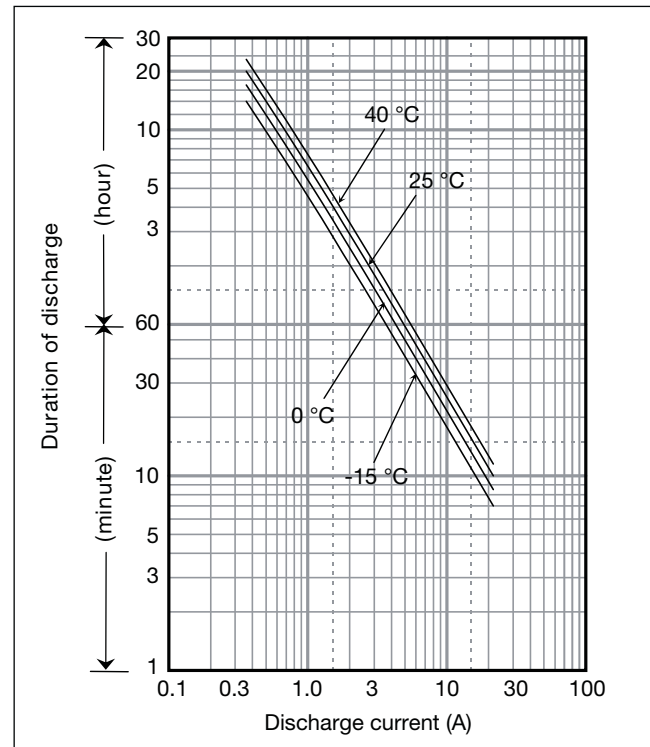

Watt Table

(Wattage/Battery)

Cut-off V	3min	5min	10min	15min	20min	30min	45min	1h	1.5h	2h	3h	4h	5h	6h	10h	20h	24h
4.8V	216	171	111	85.1	71.3	53.2	37.6	30.0	20.7	16.0	11.9	9.14	7.55	6.07	4.02	2.18	1.82
4.95V	201	160	109	84.5	70.2	52.7	37.3	30.0	20.3	15.9	11.8	9.08	7.49	6.04	4.00	2.17	1.81
5.1V	185	150	106	82.8	69.0	52.1	37.0	29.5	19.8	15.5	11.7	9.02	7.43	6.00	3.96	2.17	1.81
5.25V	165	134	99	77.1	65.5	50.9	36.4	28.9	19.4	14.9	11.5	8.96	7.37	5.92	3.94	2.16	1.80
5.4V	139	119	88	71.9	63.8	49.1	35.8	28.3	18.9	14.2	11.3	8.84	7.19	5.83	3.90	2.15	1.79

Ampere Table

(Ampere/Battery)

Cut-off V	3min	5min	10min	15min	20min	30min	45min	1h	1.5h	2h	3h	4h	5h	6h	10h	20h	24h
4.8V	38.9	30.6	19.9	14.8	12.3	9.1	6.4	5.1	3.5	2.7	2.00	1.50	1.26	1.00	0.67	0.36	0.30
4.95V	36.1	28.7	18.5	14.8	12.1	9.0	6.4	5.1	3.4	2.6	2.00	1.50	1.25	1.00	0.67	0.36	0.30
5.1V	33.3	26.9	19.0	14.4	11.9	8.9	6.3	5.0	3.3	2.5	1.95	1.50	1.24	1.00	0.66	0.36	0.30
5.25V	29.6	24.1	17.6	13.4	11.3	8.7	6.2	4.9	3.3	2.5	1.95	1.50	1.23	1.00	0.66	0.36	0.30
5.4V	25.0	21.3	15.7	12.5	11.0	8.4	6.1	4.8	3.2	2.4	1.90	1.50	1.20	1.00	0.65	0.35	0.30

Charging Method

Trickle Use	Control voltage 6.8 - 6.9V; Initial current 1.08A or smaller
-------------	--

Cut off voltage

Discharge current	0.36A - 1.44A	1.44A - 3.6A	3.6A - 7.2A	7.2A - 14.4A	14.4A - 21.6A
Cut off voltage (V)	5.25	5.1	4.95	4.65	4.35

Influence of Temperature on Trickle life

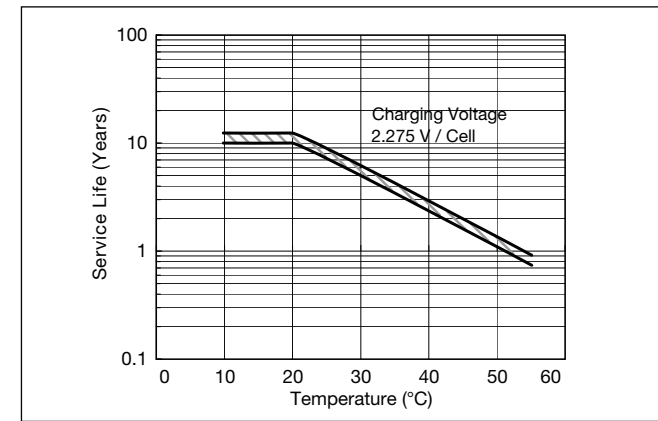

Residual capacity vs storage period

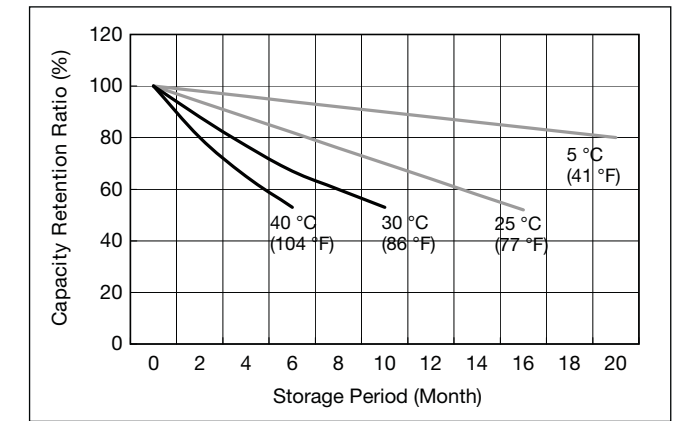

Constant-voltage and constant-current charge characteristics for Trickle use

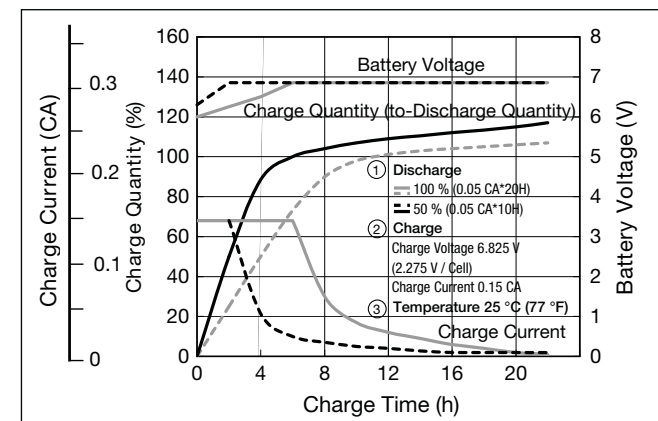

Discharge capacity by temperature and by discharge current

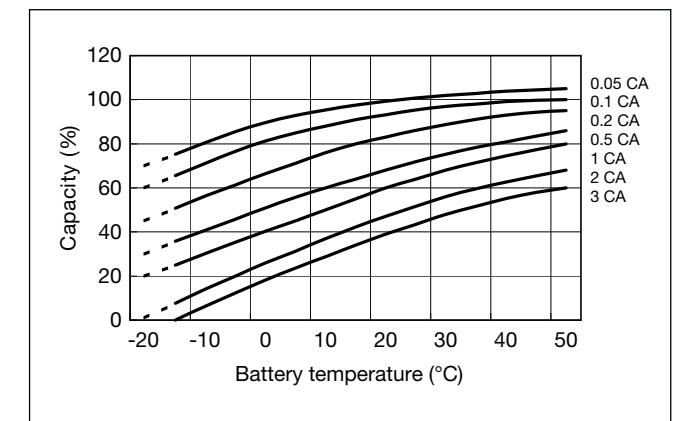

Discharge characteristics

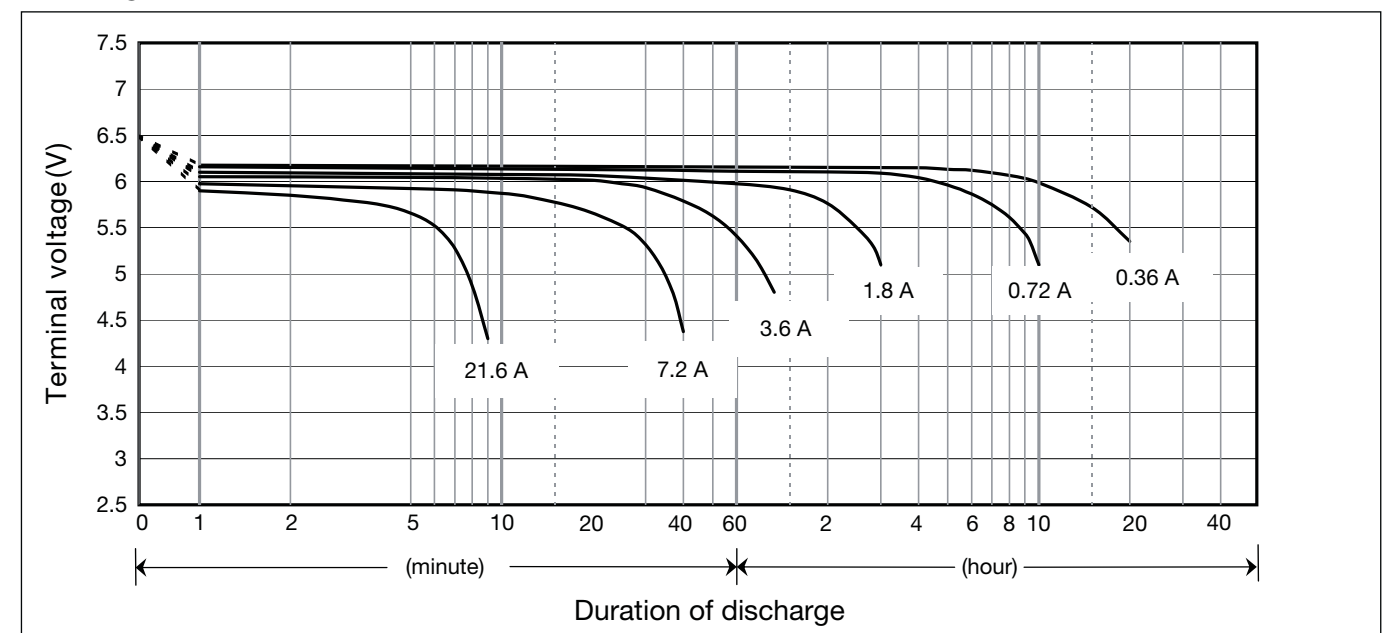

LC-P0612P



Contents indicated (including the recycle marking, etc.) are subject to change without notice.

For standby power supplies.
Expected trickle design life: 10 – 12 years at 20°C according to Eurobat.

Dimensions (mm)

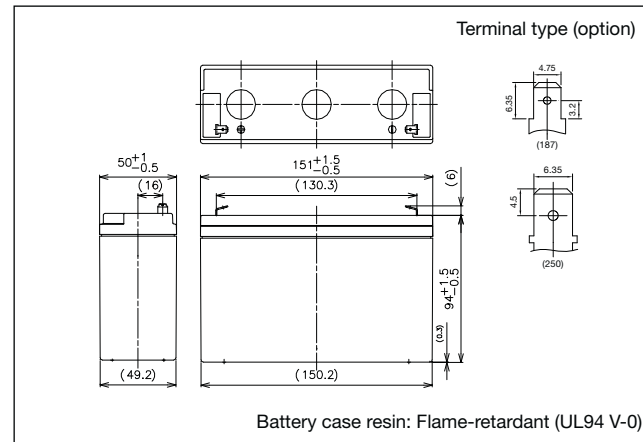

Specifications

Nominal voltage	6V	
Nominal capacity (20 hour rate)	12Ah	
Dimensions	Length	151mm
	Width	50mm
	Height	94mm
	Total Height	100mm
Approx. mass	2kg	
Terminal	Faston 187 or Faston 250 with hole	

Characteristics

Capacity (25°C)	20 hour rate	12.0Ah
	10 hour rate	11.3Ah
	5 hour rate	10.4Ah
	1 hour rate	8.1Ah
Internal resistance	Fully charged battery (25°C)	15mΩ
Temperature dependency of capacity (20 hour rate)	40°C	102%
	25°C	100%
	0°C	85%
	-15°C	65%
Self discharge (25°C)	After 3 months	91%
	After 6 months	82%
	After 12 months	64%

Duration of discharge vs Discharge current

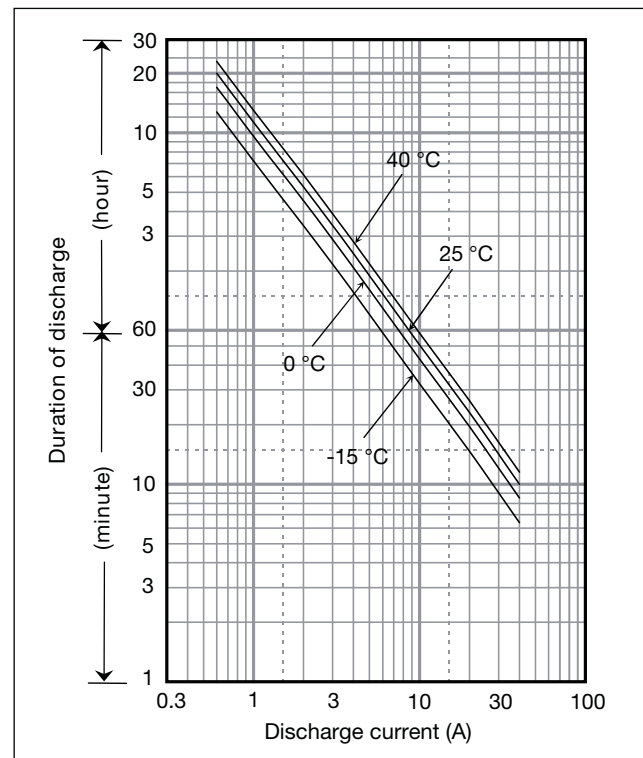

Watt Table

Cut-off V	(Wattage/Battery)																
	3min	5min	10min	15min	20min	30min	45min	1h	1.5h	2h	3h	4h	5h	6h	10h	20h	24h
4.8V	340	279	192	149	124	91.3	68.7	52.4	35.1	27.2	19.0	14.4	12.0	10.9	6.66	3.61	3.01
4.95V	325	269	186	144	121	88.3	67.5	51.8	35.0	27.1	18.9	14.4	12.0	10.9	6.66	3.61	3.01
5.1V	304	253	181	141	118	88.3	66.9	51.2	34.5	26.9	18.7	14.4	12.0	10.8	6.60	3.61	3.01
5.25V	278	237	171	136	115	86.0	66.3	50.1	34.2	26.6	18.4	14.3	12.0	10.8	6.60	3.60	3.00
5.4V	247	217	161	131	113	83.1	61.6	48.9	33.1	26.0	18.1	14.2	11.9	10.7	6.54	3.59	2.99

Ampere Table

Cut-off V	(Ampere/Battery)																
	3min	5min	10min	15min	20min	30min	45min	1h	1.5h	2h	3h	4h	5h	6h	10h	20h	24h
4.8V	61.1	50.1	34.3	25.9	21.3	15.6	11.7	8.90	5.95	4.60	3.20	2.41	2.01	1.81	1.11	0.602	0.502
4.95V	58.4	48.2	33.3	25.0	20.8	15.1	11.5	8.80	5.92	4.58	3.18	2.41	2.01	1.81	1.11	0.602	0.502
5.1V	54.6	45.4	32.4	24.5	20.3	15.1	11.4	8.70	5.85	4.55	3.15	2.41	2.00	1.80	1.10	0.601	0.501
5.25V	50.0	42.6	30.6	23.6	19.9	14.7	11.3	8.50	5.80	4.50	3.10	2.40	2.00	1.80	1.10	0.600	0.500
5.4V	44.5	38.9	28.7	22.7	19.4	14.2	10.5	8.30	5.60	4.40	3.05	2.38	1.99	1.79	1.09	0.598	0.498

Charging Method

Trickle Use	Control voltage: 6.8 - 6.9V; Initial current: 1.8A or smaller
-------------	---

Influence of Temperature on Trickle life

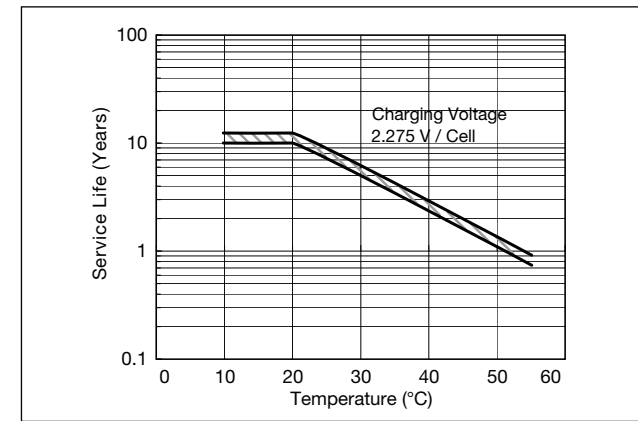

Constant-voltage and constant-current charge characteristics for Trickle use

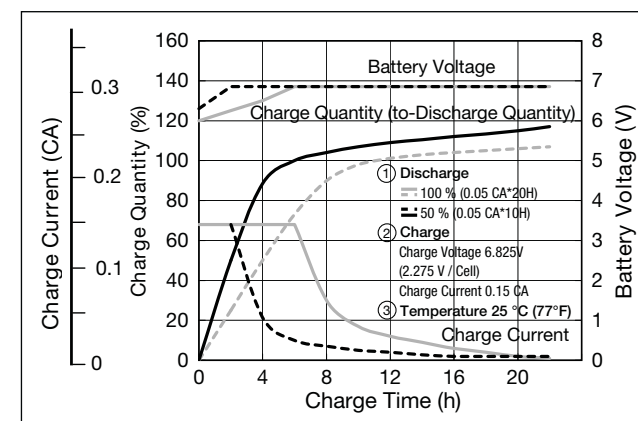

Discharge characteristics

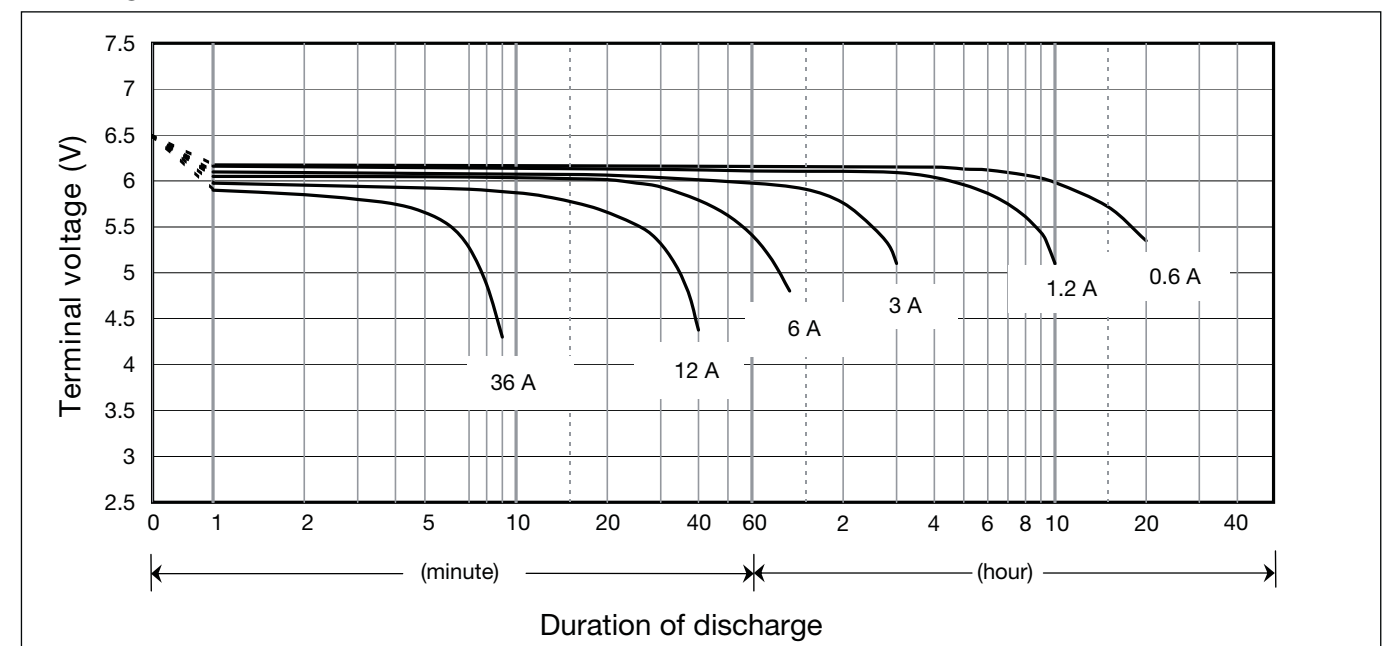

Cut off voltage

Discharge current	0.6A - 2.4A	2.4A - 6A	6A - 12A	12A - 24A	24A - 36A
Cut off voltage (V)	5.25	5.1	4.95	4.65	4.35

Residual capacity vs storage period

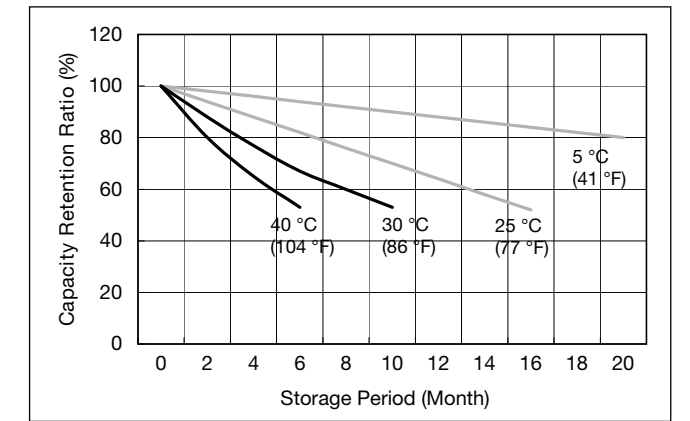

Discharge capacity by temperature and by discharge current

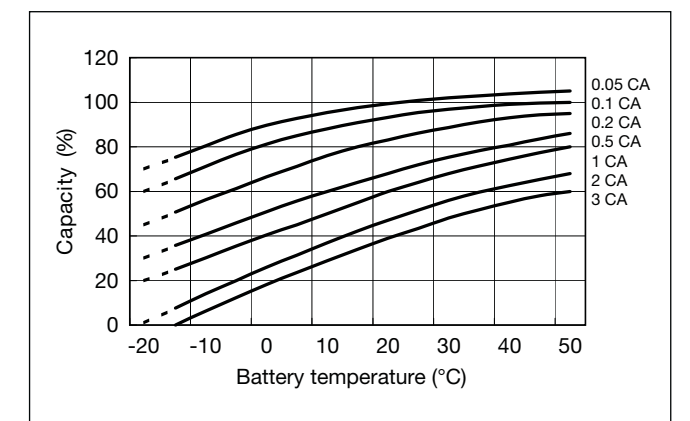

LC-X06200P*1

For standby power supplies.
Expected trickle design life: 10 – 12 years at 20°C according to Eurobat.



Dimensions (mm)

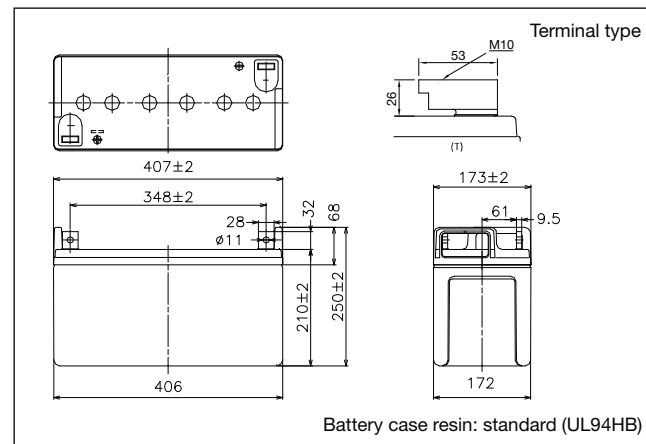

Specifications

Nominal voltage	6V	
Nominal capacity (20 hour rate)	200Ah	
Dimensions	Length	407mm
	Width	173mm
	Height	210mm
	Total Height	250mm
Approx. mass	41kg	
Terminal	M10 Bolt and Nut type	

Duration of discharge vs Discharge current

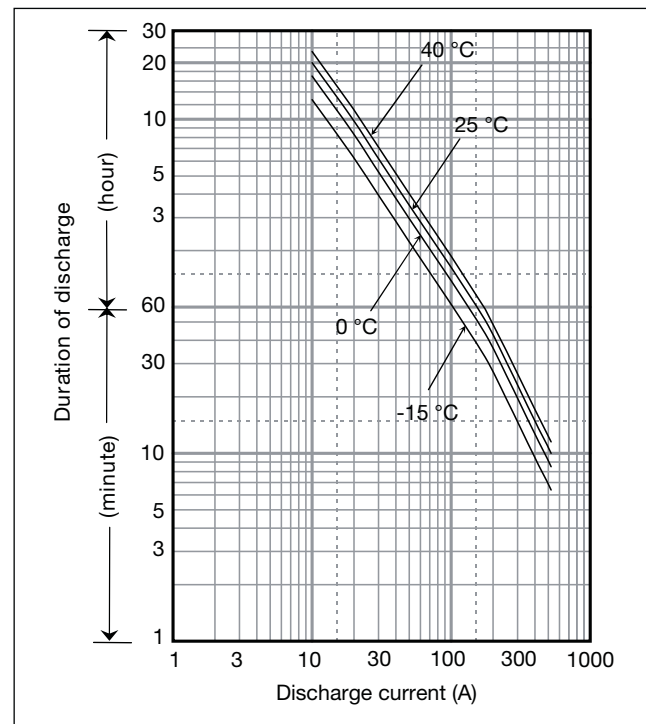

Characteristics

Capacity (25°C)	20 hour rate 10 hour rate 5 hour rate 1 hour rate	200Ah 194Ah 184Ah 120Ah
Internal resistance	Fully charged battery (25°C)	2mΩ
Temperature dependency of capacity (20 hour rate)	40°C 25°C 0°C -15°C	102% 100% 85% 65%
Self discharge (25°C)	After 3 months After 6 months After 12 months	91% 82% 64%

Watt Table

Cut-off V	(Wattage/Battery)														
	10min	15min	20min	30min	45min	1h	1.5h	2h	3h	4h	5h	6h	10h	20h	24h
4.8V	2306	1834	1592	1206	892	733	582	430	281	226	170	154	88.3	47.0	38.5
4.95V	2254	1790	1554	1177	869	714	567	419	276	221	165	149	85.3	47.0	38.5
5.1V	2204	1726	1498	1139	877	694	551	413	272	216	160	145	84.3	46.5	38.0
5.25V	2134	1705	1487	1130	852	675	536	405	267	213	160	145	83.3	46.5	38.0
5.4V	1947	1624	1479	1094	840	666	528	395	262	208	155	150	82.3	45.5	37.2

Ampere Table

Cut-off V	(Ampere/Battery)														
	10min	15min	20min	30min	45min	1h	1.5h	2h	3h	4h	5h	6h	10h	20h	24h
4.8V	530	402	348	260	184	153	104	82.6	55.4	42.8	37.2	31.2	19.8	10.0	8.4
4.95V	524	400	346	258	179	152	102	82.0	54.4	42.4	36.6	31.2	19.8	10.0	8.4
5.1V	522	398	342	254	178	151	101	81.0	54.0	42.0	36.0	31.0	19.6	10.0	8.4
5.25V	476	376	326	250	176	150	100	80.0	54.0	42.0	36.0	31.0	19.6	10.0	8.4
5.4V	452	364	318	246	152	130	90	76.0	51.6	41.0	35.6	30.0	19.4	9.8	8.4

*1 This battery is also available with a flame retardant battery case resin (UL94 V-0).

Charging Method

Trickle use	Control voltage: 6.8 - 6.9V; Initial current 30A or smaller
-------------	---

Cut off voltage

Discharge current	10A - 40A	40A - 100A	100A - 200A	200A - 400A	400A - 600A
Cut off voltage (V)	5.25	5.1	4.95	4.65	4.35

Influence of Temperature on Trickle life

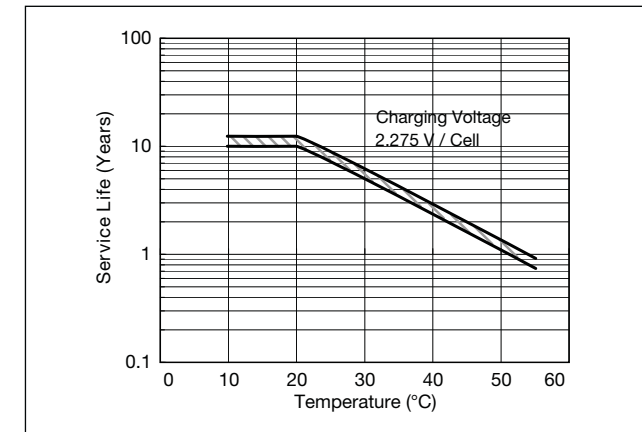

Residual capacity vs storage period

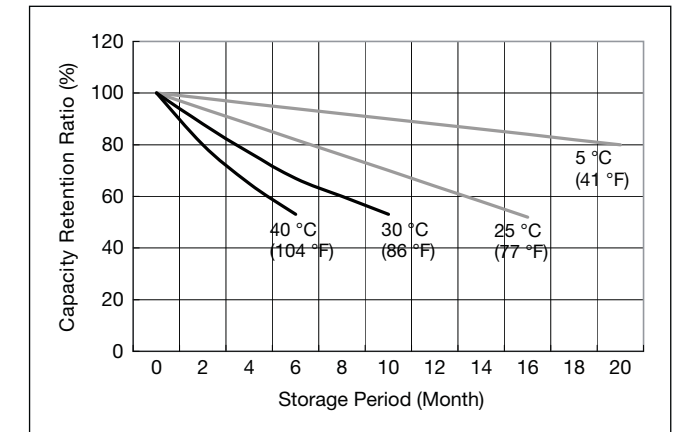

Constant-voltage and constant-current charge characteristics for Trickle use

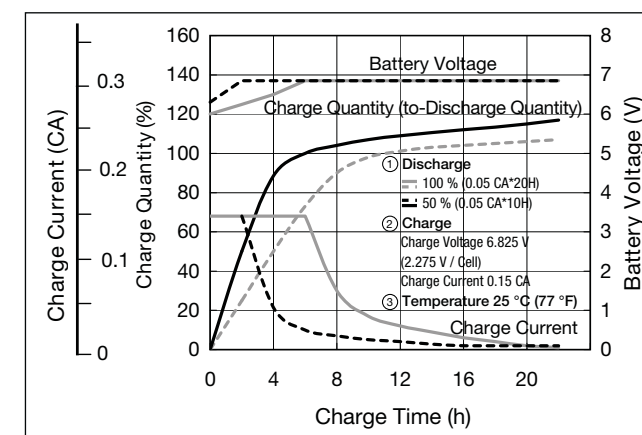

Discharge capacity by temperature and by discharge current

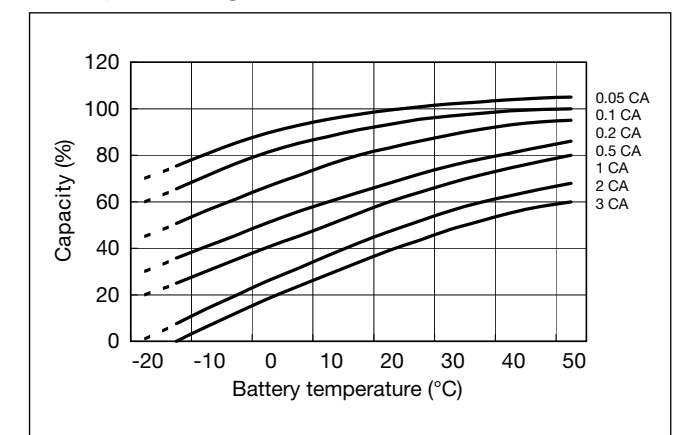

Discharge characteristics

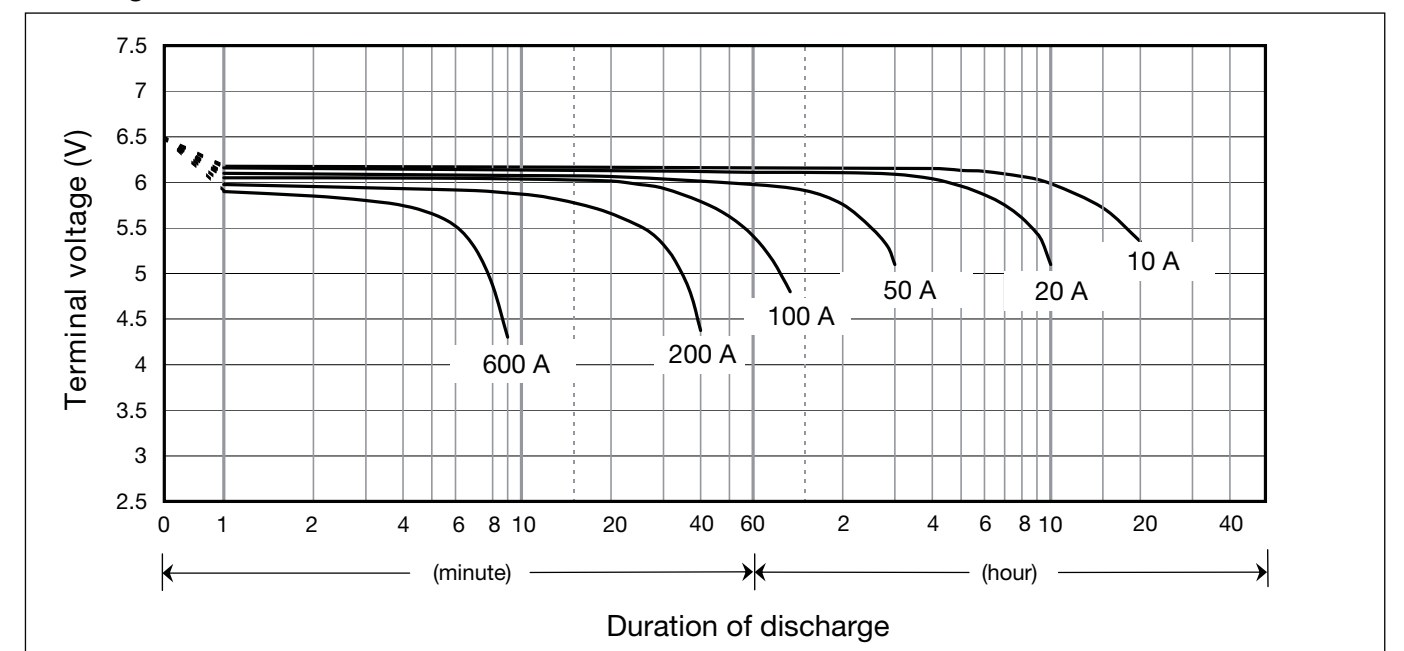

LC-P122R2P



Contents indicated (including the recycle marking, etc.) are subject to change without notice.

For standby power supplies.
Expected trickle design life: 10 – 12 years at 20°C according to Eurobat.

Dimensions (mm)

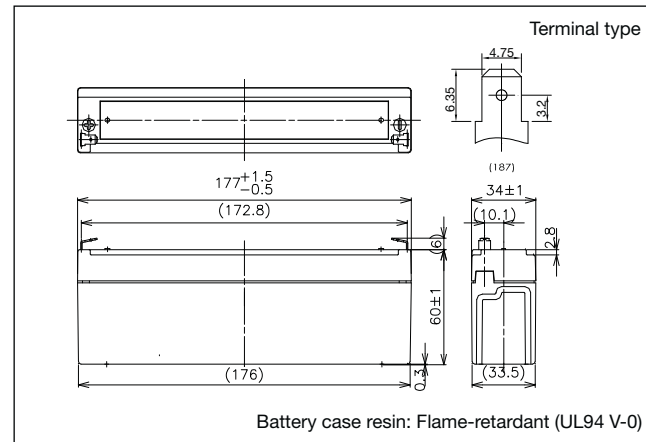

Specifications

Nominal voltage	12V	
Nominal capacity (20 hour rate)	2.2Ah	
Dimensions	Length	177mm
	Width	34mm
	Height	60mm
	Total Height	66mm
Approx. mass	0.8kg	
Terminal	Faston 187	

Characteristics

Capacity (25°C)	20 hour rate	2.2Ah
	10 hour rate	2.0Ah
	5 hour rate	1.8Ah
	1 hour rate	1.3Ah
Internal resistance	Fully charged battery (25°C)	70mΩ
Temperature dependency of capacity (20 hour rate)	40°C	102%
	25°C	100%
	0°C	85%
	-15°C	65%
Self discharge (25°C)	After 3 months	91%
	After 6 months	82%
	After 12 months	64%

Duration of discharge vs Discharge current

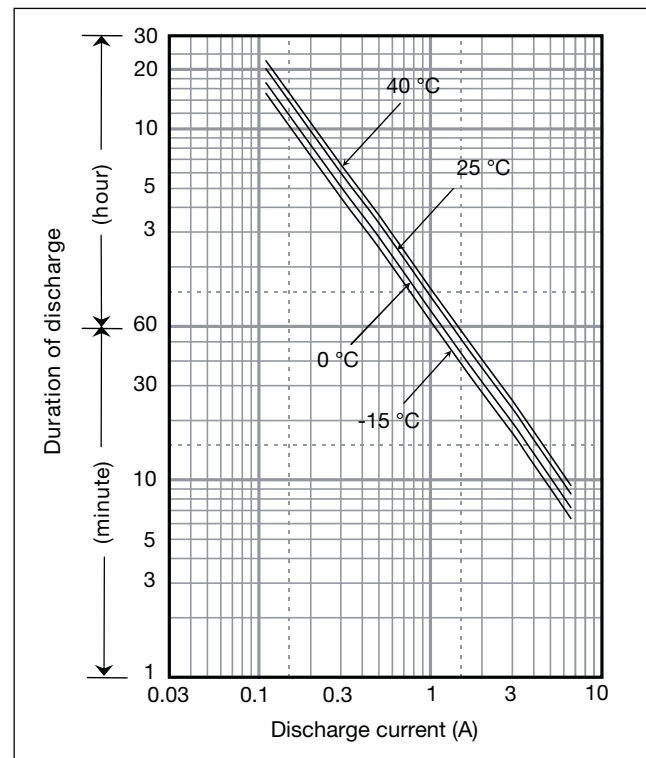

Watt Table

Cut-off V	(Wattage/Battery)																
	3min	5min	10min	15min	20min	30min	45min	1h	1.5h	2h	3h	4h	5h	6h	10h	20h	24h
9.6V	132	104	68.1	52.0	43.6	32.5	23.0	18.4	12.6	9.77	7.27	5.59	4.61	3.71	2.46	1.33	1.11
9.9V	123	97.8	66.7	51.7	42.9	32.2	22.8	18.4	12.4	9.70	7.24	5.55	4.58	3.69	2.45	1.33	1.11
10.2V	113	91.6	65.0	50.6	42.2	31.8	22.6	18.0	12.1	9.44	7.16	5.51	4.54	3.66	2.42	1.32	1.10
10.5V	101	82.1	60.2	47.1	40.1	31.1	22.2	17.6	11.9	9.12	7.05	5.48	4.50	3.62	2.41	1.32	1.10
10.8V	85	72.6	53.7	43.9	39.0	30.0	21.9	17.3	11.5	8.68	6.91	5.40	4.39	3.56	2.38	1.31	1.09

Ampere Table

Cut-off V	(Ampere/Battery)																
	3min	5min	10min	15min	20min	30min	45min	1h	1.5h	2h	3h	4h	5h	6h	10h	20h	24h
9.6V	11.9	9.35	6.08	4.52	3.76	2.78	1.96	1.56	1.07	0.825	0.611	0.468	0.385	0.309	0.205	0.111	0.0926
9.9V	11.0	8.77	5.96	4.49	3.70	2.75	1.94	1.56	1.05	0.819	0.608	0.464	0.382	0.308	0.204	0.111	0.0923
10.2V	10.2	8.22	5.81	4.40	3.64	2.72	1.93	1.53	1.03	0.798	0.602	0.461	0.379	0.306	0.202	0.110	0.0920
10.5V	9.0	7.36	5.38	4.09	3.45	2.66	1.89	1.50	1.01	0.770	0.593	0.458	0.376	0.302	0.201	0.110	0.0917
10.8V	7.6	6.51	4.80	3.82	3.36	2.57	1.86	1.47	0.98	0.733	0.581	0.452	0.367	0.297	0.199	0.109	0.0911

Charging Method

Trickle Use	Control voltage: 13.6 - 13.8V; Initial current: 0.33A or smaller
-------------	---

Cut off voltage

Discharge current	0.011A - 0.44A	0.44A - 1.1A	1.1A - 2.2A	2.2A - 4.4A	4.4A - 6.6A
Cut off voltage (V)	10.5	10.2	9.9	9.3	8.7

Influence of Temperature on Trickle life

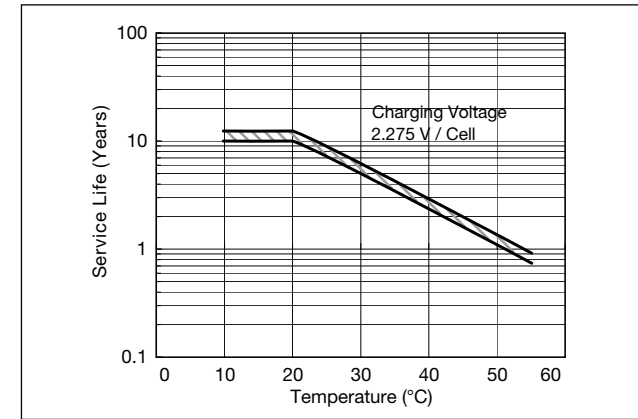

Residual capacity vs storage period

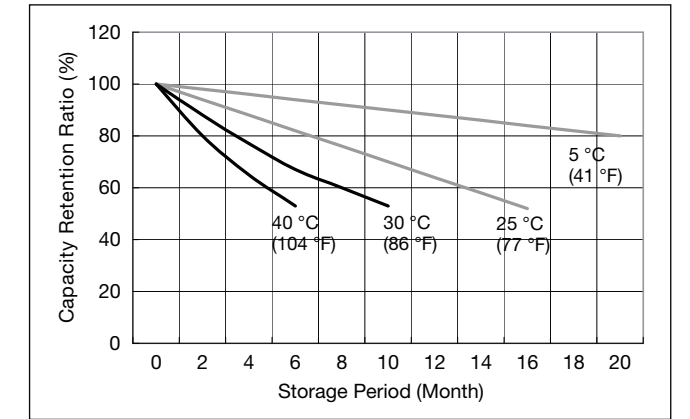

Constant-voltage and constant-current charge characteristics for Trickle use

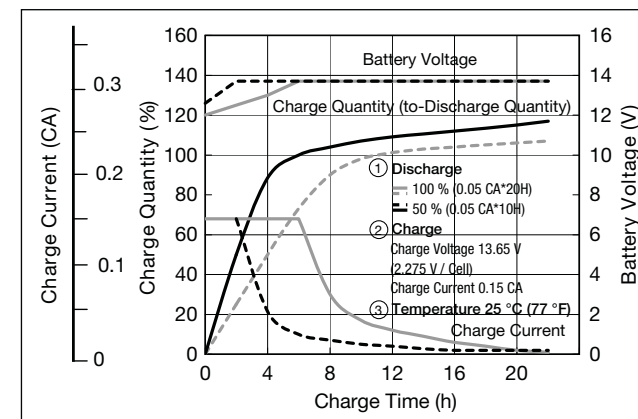

Discharge capacity by temperature and by discharge current

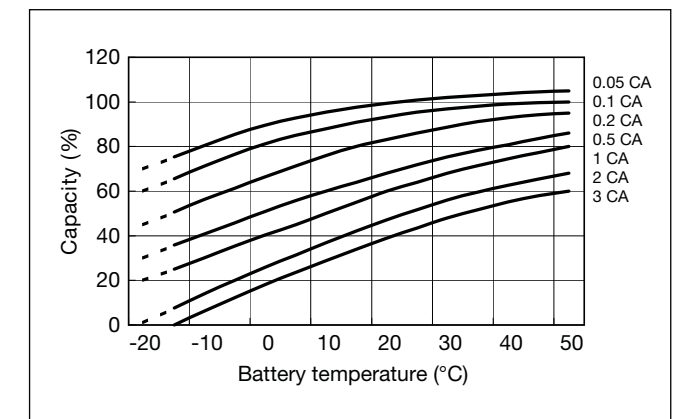

Discharge characteristics

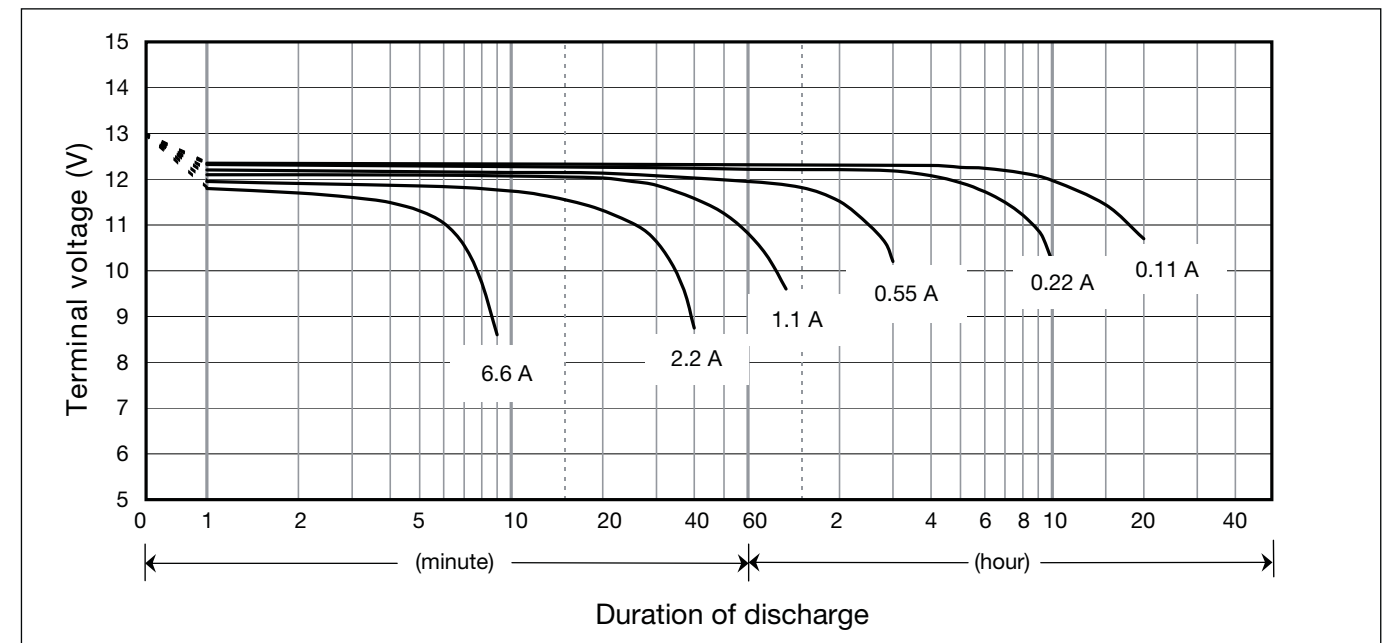

LC-P123R4P



For standby power supplies.
Expected trickle design life: 10 – 12 years at 20°C according to Eurobat.

Dimensions (mm)

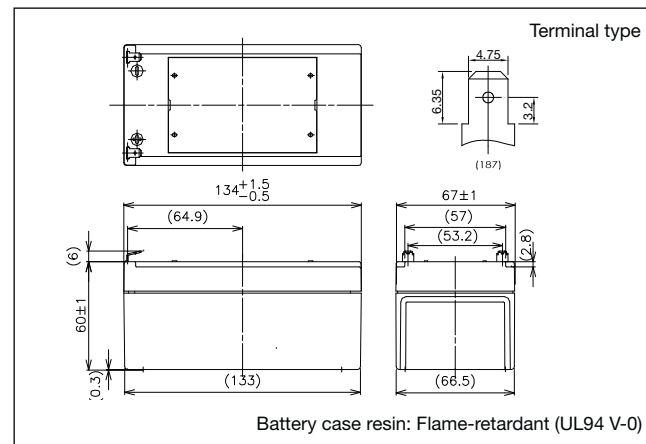

Specifications

Nominal voltage	12V	
Nominal capacity (20 hour rate)	3.4Ah	
Dimensions	Length	134mm
	Width	67mm
	Height	60mm
	Total Height	66mm
Approx. mass	1.2kg	
Terminal	Faston 187	

Characteristics

Capacity (25°C)	20 hour rate	3.4Ah
	10 hour rate	3.0Ah
	5 hour rate	2.7Ah
	1 hour rate	2.1Ah
Internal resistance	Fully charged battery (25°C)	60mΩ
Temperature dependency of capacity (20 hour rate)	40°C	102%
	25°C	100%
	0°C	85%
	-15°C	65%
Self discharge (25°C)	After 3 months	91%
	After 6 months	82%
	After 12 months	64%

Duration of discharge vs Discharge current

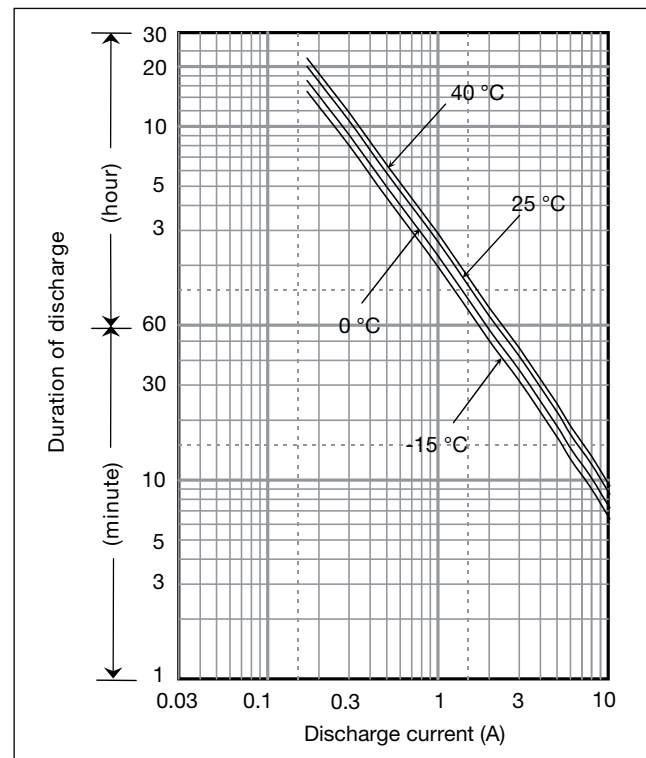

Watt Table

Cut-off V	(Wattage/Battery)																
	3min	5min	10min	15min	20min	30min	45min	1h	1.5h	2h	3h	4h	5h	6h	10h	20h	24h
9.6V	204	161	105	80.4	67.4	50.3	35.5	28.4	19.6	15.0	11.3	8.63	7.13	5.80	3.81	2.06	1.72
9.9V	190	151	103	79.8	66.3	49.7	35.3	28.4	19.2	14.9	11.2	8.58	7.07	5.78	3.80	2.05	1.71
10.2V	175	142	100	78.2	65.2	49.2	34.9	27.8	18.8	14.5	11.1	8.52	7.01	5.73	3.76	2.05	1.71
10.5V	155	127	93	72.8	61.9	48.1	34.4	27.3	18.4	14.0	11.0	8.46	6.96	5.66	3.74	2.04	1.70
10.8V	131	112	83	67.9	60.3	46.4	33.8	26.7	17.8	13.4	10.7	8.46	6.79	5.66	3.68	1.98	1.70

Ampere Table

Cut-off V	(Ampere/Battery)																
	3min	5min	10min	15min	20min	30min	45min	1h	1.5h	2h	3h	4h	5h	6h	10h	20h	24h
9.6V	18.4	14.4	9.40	6.99	5.81	4.30	3.02	2.41	1.66	1.26	0.949	0.722	0.595	0.484	0.318	0.171	0.143
9.9V	17.0	13.6	9.21	6.94	5.71	4.25	3.00	2.41	1.62	1.26	0.945	0.718	0.590	0.482	0.316	0.171	0.143
10.2V	15.7	12.7	8.97	6.80	5.62	4.20	2.97	2.36	1.59	1.22	0.935	0.713	0.586	0.478	0.313	0.170	0.142
10.5V	14.0	11.4	8.31	6.33	5.34	4.11	2.93	2.31	1.56	1.18	0.921	0.708	0.581	0.472	0.312	0.170	0.142
10.8V	11.8	10.1	7.41	5.90	5.19	3.97	2.88	2.27	1.51	1.13	0.897	0.708	0.567	0.472	0.307	0.165	0.142

Charging Method

Trickle Use	Control voltage: 13.6 - 13.8V; Initial current: 0.51A or smaller
-------------	---

Cut off voltage

Discharge current	0.17A - 0.68A	0.68A - 1.7A	1.7A - 3.4A	3.4A - 6.8A	6.8A - 10.2A
Cut off voltage (V)	10.5	10.2	9.9	9.3	8.7

Influence of Temperature on Trickle life

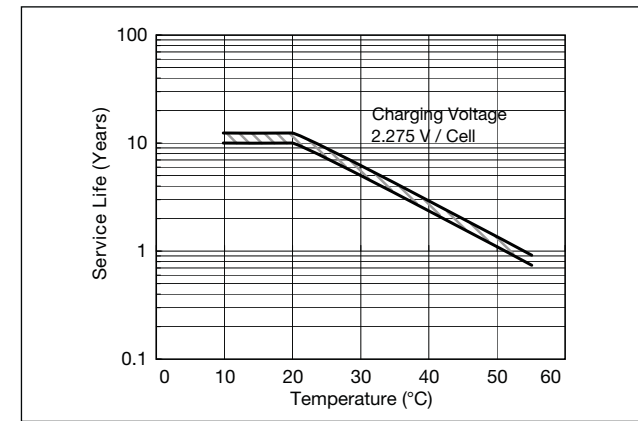

Residual capacity vs storage period

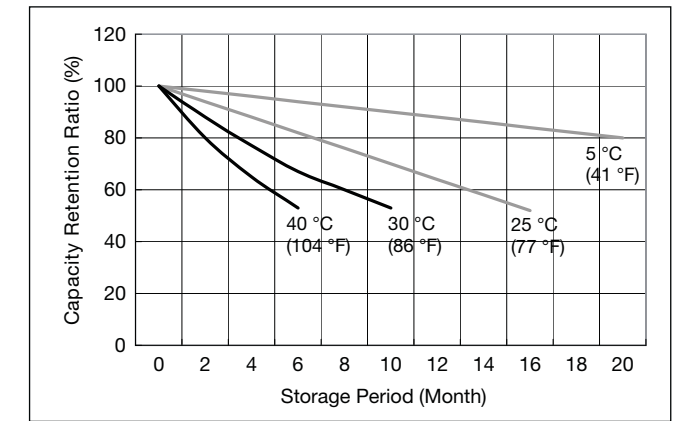

Constant-voltage and constant-current charge characteristics for Trickle use

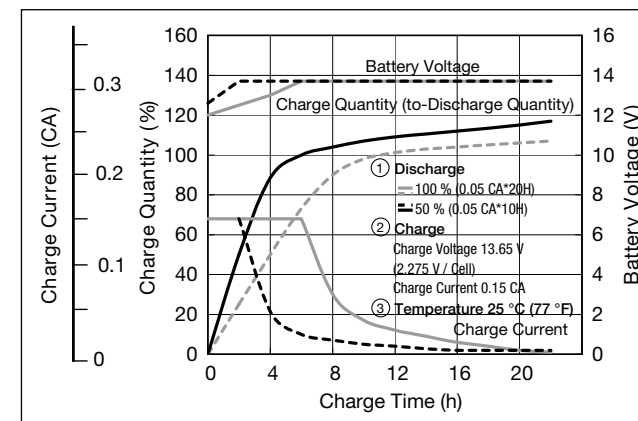

Discharge capacity by temperature and by discharge current

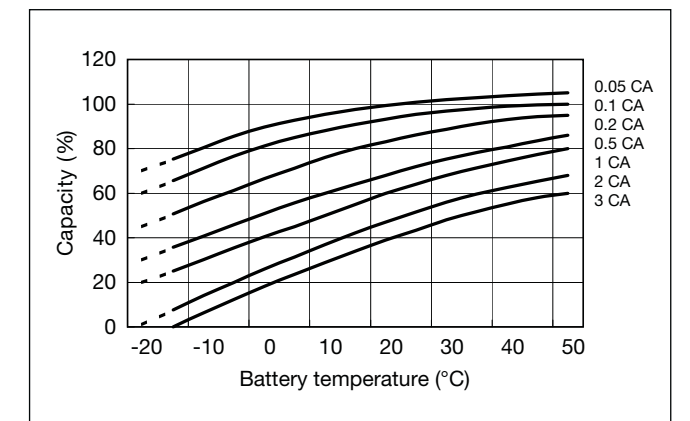

Discharge characteristics

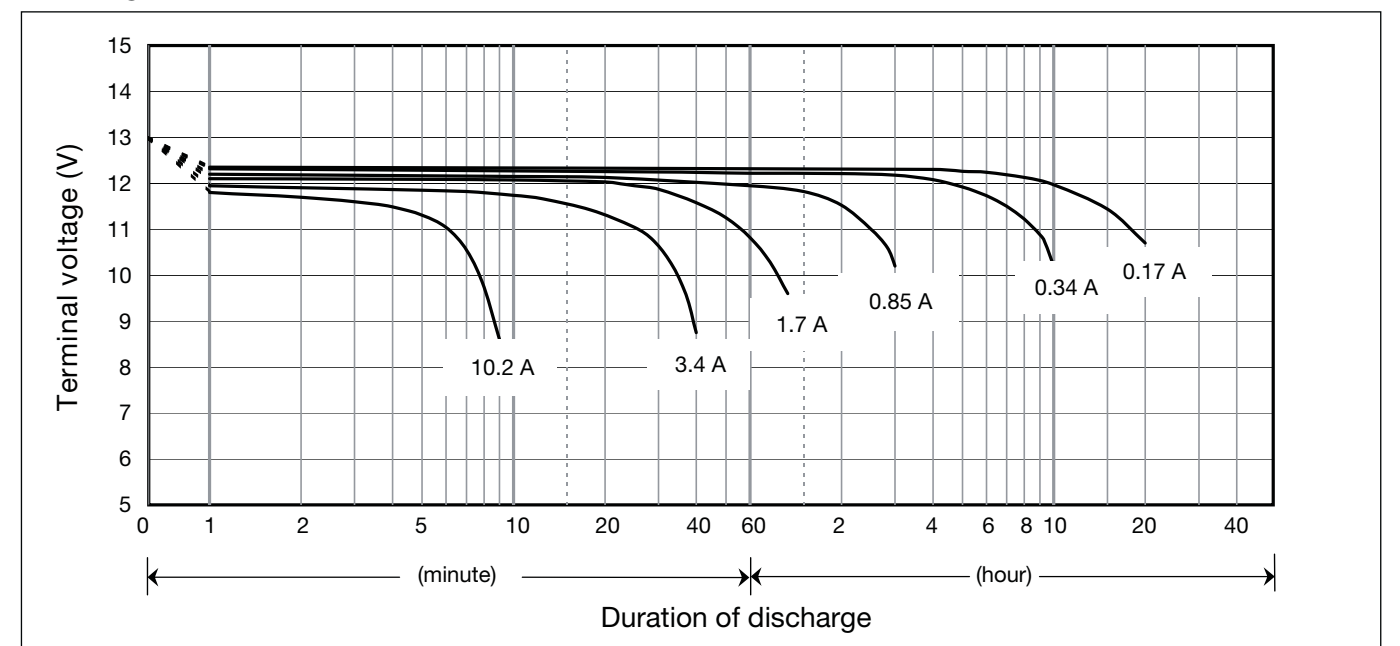

LC-P127R2P

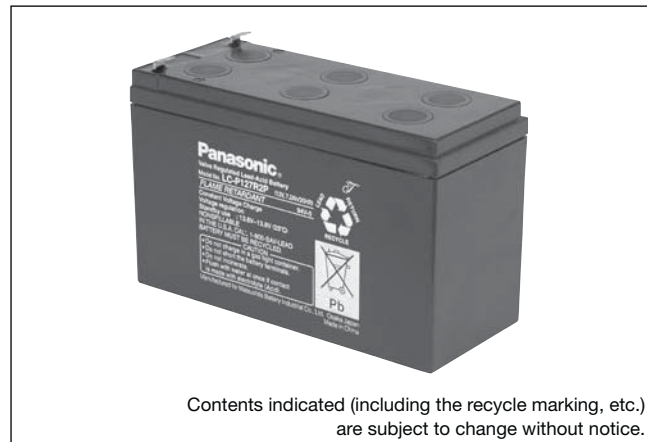

Contents indicated (including the recycle marking, etc.) are subject to change without notice.

For standby power supplies.
Expected trickle design life: 10 – 12 years at 20°C according to Eurobat.

Dimensions (mm)

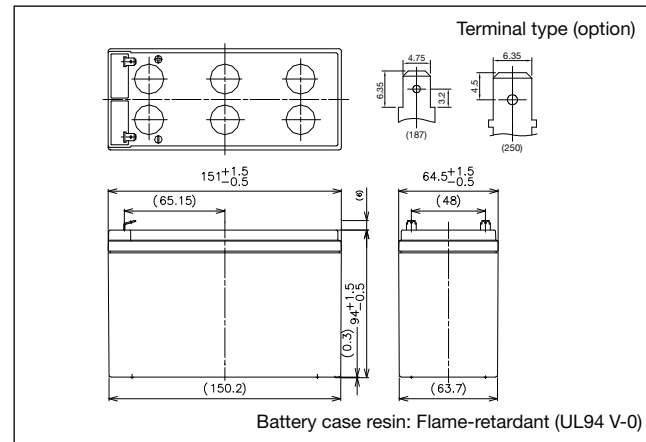

Specifications

Nominal voltage	12V	
Nominal capacity (20 hour rate)	7.2Ah	
Dimensions	Length	151mm
	Width	64.5mm
	Height	94mm
	Total Height	100mm
Approx. mass	2.5kg	
Terminal	Faston 187 or Faston 250 with hole	

Characteristics

Capacity (25°C)	20 hour rate	7.2Ah
	10 hour rate	6.8Ah
	5 hour rate	6.3Ah
	1 hour rate	4.9Ah
Internal resistance	Fully charged battery (25°C)	21mΩ
Temperature dependency of capacity (20 hour rate)	40°C	102%
	25°C	100%
	0°C	85%
	-15°C	65%
Self discharge (25°C)	After 3 months	91%
	After 6 months	82%
	After 12 months	64%

Duration of discharge vs Discharge current

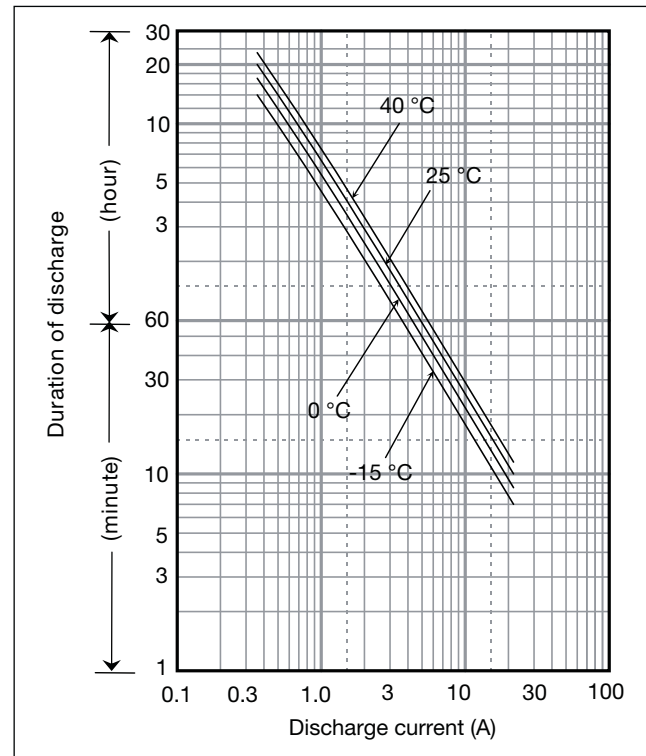

Watt Table

Cut-off V	(Wattage/Battery)																
	3min	5min	10min	15min	20min	30min	45min	1h	1.5h	2h	3h	4h	5h	6h	10h	20h	24h
9.6V	433	341	223	170	143	106	75.1	60.1	41.3	32.0	23.8	18.3	15.1	12.1	8.04	4.36	3.64
9.9V	401	320	218	169	140	105	74.7	60.1	40.5	31.7	23.7	18.2	15.0	12.1	8.00	4.34	3.62
10.2V	370	300	213	166	138	104	74.0	58.9	39.7	30.9	23.4	18.0	14.9	12.0	7.92	4.33	3.61
10.5V	329	269	197	154	131	102	72.8	57.7	38.9	29.8	23.1	17.9	14.7	11.8	7.88	4.32	3.60
10.8V	278	237	176	144	128	98	71.6	56.5	37.8	28.4	22.6	17.7	14.4	11.7	7.80	4.30	3.58

Ampere Table

Cut-off V	(Ampere/Battery)																
	3min	5min	10min	15min	20min	30min	45min	1h	1.5h	2h	3h	4h	5h	6h	10h	20h	24h
9.6V	38.9	30.6	19.9	14.8	12.3	9.1	6.4	5.1	3.50	2.70	2.00	1.53	1.26	1.012	0.670	0.363	0.303
9.9V	36.1	28.7	19.5	14.7	12.1	9.0	6.4	5.1	3.43	2.68	1.99	1.52	1.25	1.008	0.667	0.362	0.302
10.2V	33.3	26.9	19.0	14.4	11.9	8.9	6.3	5.0	3.36	2.61	1.97	1.51	1.24	1.000	0.660	0.361	0.301
10.5V	29.6	24.1	17.6	13.4	11.3	8.7	6.2	4.9	3.29	2.52	1.94	1.50	1.23	0.988	0.657	0.360	0.300
10.8V	25.0	21.3	15.7	12.5	11.0	8.4	6.1	4.8	3.20	2.40	1.90	1.48	1.20	0.972	0.650	0.358	0.298

Charging Method

Trickle Use	Control voltage: 13.6 - 13.8V; Initial current: 1.08A or smaller
-------------	---

Influence of Temperature on Trickle life

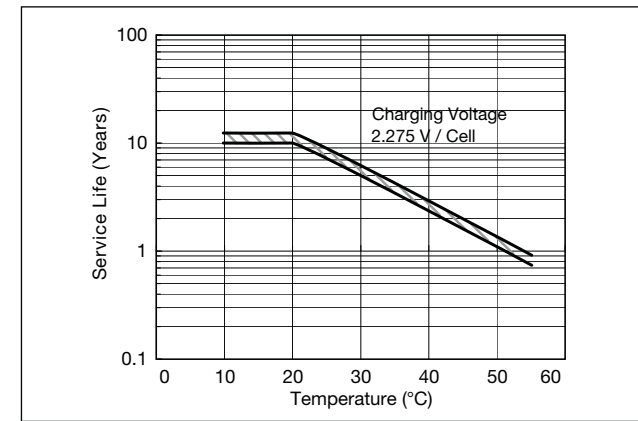

Cut off voltage

Discharge current	0.36A - 1.44A	1.44A - 3.6A	3.6A - 7.2A	7.2A - 14.4A	14.4A - 21.6A
Cut off voltage (V)	10.5	10.2	9.9	9.3	8.7

Residual capacity vs storage period

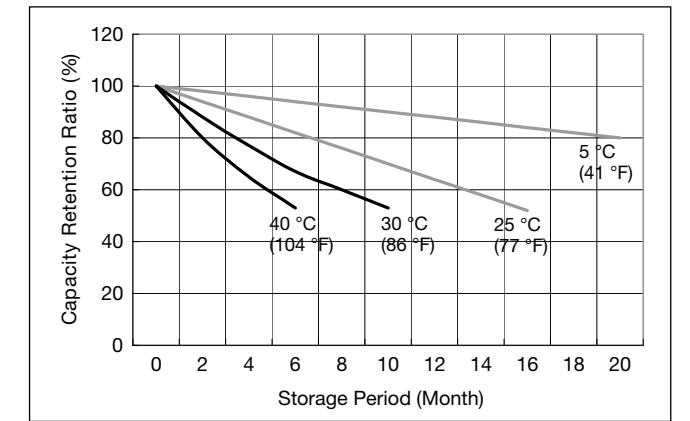

Constant-voltage and constant-current charge characteristics for Trickle use

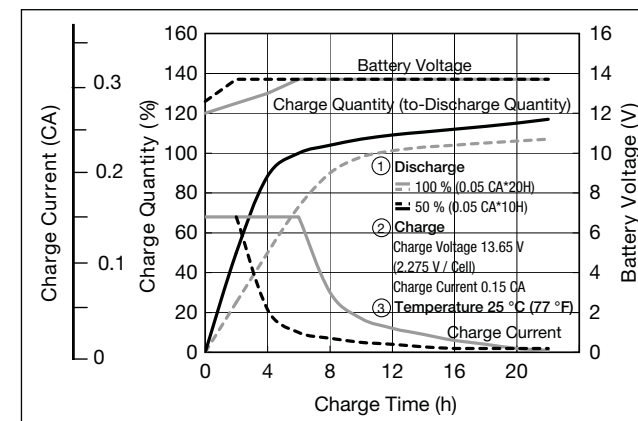

Discharge capacity by temperature and by discharge current

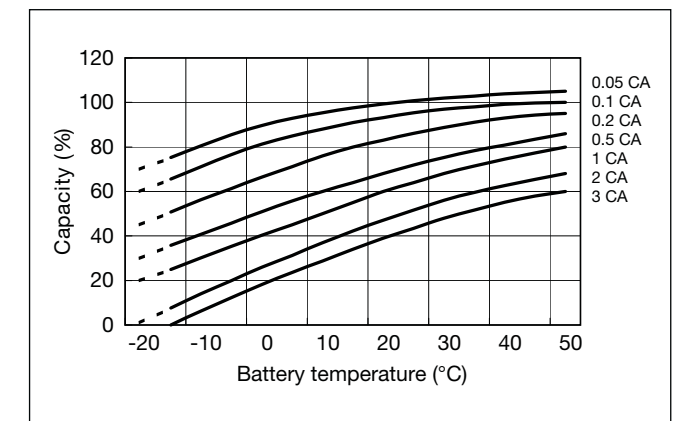

Discharge characteristics

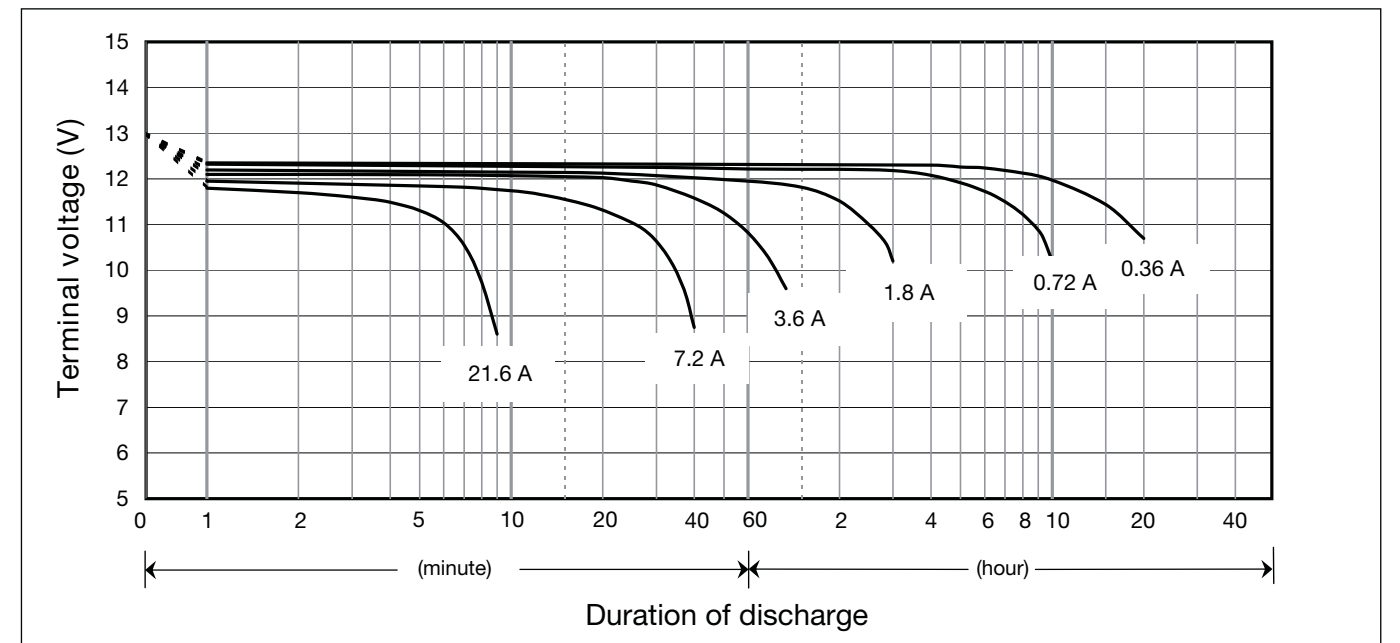

LC-PA1212P

For standby power supplies.
Expected trickle design life: 10 – 12 years at 20°C according to Eurobat.

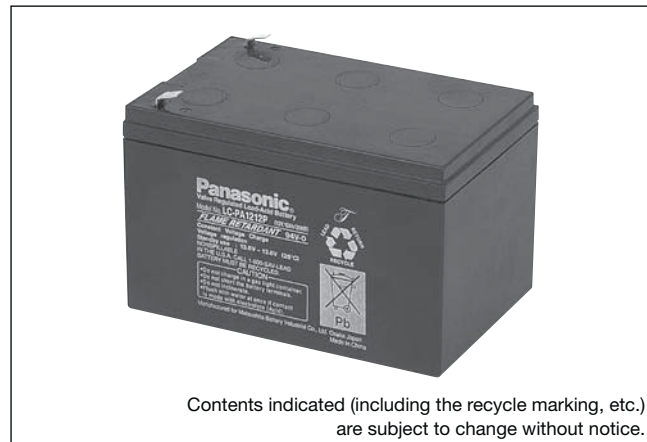

Dimensions (mm)

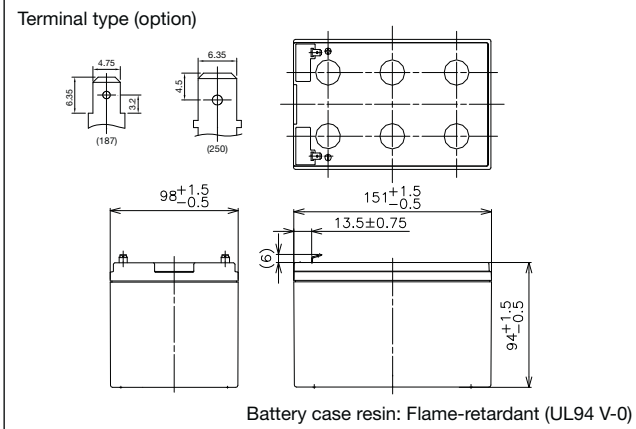

Specifications

Nominal voltage	12V	
Nominal capacity (20 hour rate)	12Ah	
Dimensions	Length	151mm
	Width	98mm
	Height	94mm
	Total Height	100mm
Approx. mass	3.8kg	
Terminal	Faston 187 or Faston 250 with hole	

Duration of discharge vs Discharge current

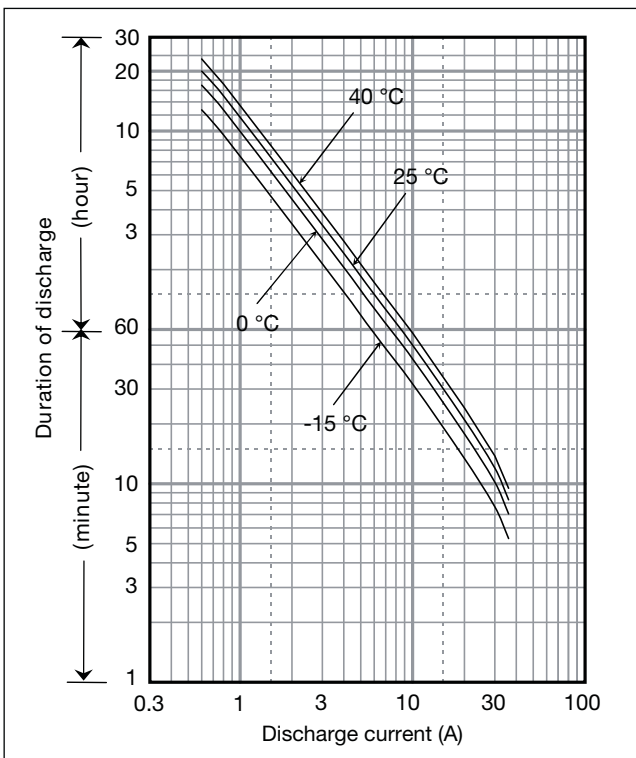

Characteristics

Capacity (25°C)	20 hour rate	12.0Ah
	10 hour rate	11.3Ah
	5 hour rate	10.4Ah
	1 hour rate	8.1Ah
Internal resistance	Fully charged battery (25°C)	30mΩ
Temperature dependency of capacity (20 hour rate)	40°C	102%
	25°C	100%
	0°C	85%
	-15°C	65%
Self discharge (25°C)	After 3 months	91%
	After 6 months	82%
	After 12 months	64%

Watt Table

Cut-off V	(Wattage/Battery)																	
	3min	5min	10min	15min	20min	30min	45min	1h	1.5h	2h	3h	4h	5h	6h	10h	20h	24h	
9.6V	679	559	384	298	247	183	137	105	70.3	54.5	38.1	28.8	24.1	21.7	13.3	7.22	6.02	
9.9V	649	537	373	288	241	177	135	104	69.9	54.2	37.8	28.8	24.1	21.7	13.3	7.22	6.02	
10.2V	607	506	363	282	235	177	134	102	69.1	53.9	37.5	28.8	24.0	21.6	13.2	7.21	6.01	
10.5V	556	475	343	271	231	172	133	100	68.5	53.3	36.9	28.7	24.0	21.6	13.2	7.20	6.00	
10.8V	495	434	321	261	225	166	123	98	66.1	52.1	36.3	28.4	23.8	21.5	13.1	7.18	5.98	

Ampere Table

Cut-off V	(Ampere/Battery)																	
	3min	5min	10min	15min	20min	30min	45min	1h	1.5h	2h	3h	4h	5h	6h	10h	20h	24h	
9.6V	61.1	50.1	34.3	25.9	21.3	15.6	11.7	8.90	5.95	4.60	3.20	2.41	2.01	1.81	1.11	0.602	0.502	
9.9V	58.4	48.2	33.3	25.0	20.8	15.1	11.5	8.80	5.92	4.58	3.18	2.41	2.01	1.81	1.11	0.602	0.502	
10.2V	54.6	45.4	32.4	24.5	20.3	15.1	11.4	8.70	5.85	4.55	3.15	2.41	2.00	1.80	1.10	0.601	0.501	
10.5V	50.0	42.6	30.6	23.6	19.9	14.7	11.3	8.50	5.80	4.50	3.10	2.40	2.00	1.80	1.10	0.600	0.500	
10.8V	44.5	38.9	28.7	22.7	19.4	14.2	10.5	8.30	5.60	4.40	3.05	2.38	1.99	1.79	1.09	0.598	0.498	

Charging Method

Trickle Use	Control voltage: 13.6 - 13.8V; Initial current: 1.8A or smaller
-------------	--

Cut off voltage

Discharge current	0.6A - 2.4A	2.4A - 6A	6A - 12A	12A - 24A	24A - 36A
Cut off voltage (V)	10.5	10.2	9.9	9.3	8.7

Influence of Temperature on Trickle life

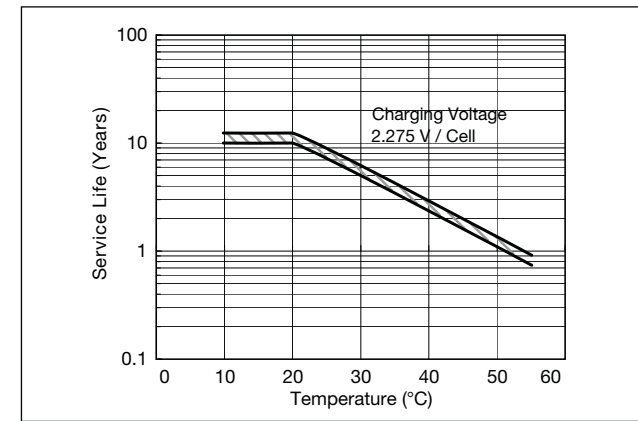

Residual capacity vs storage period

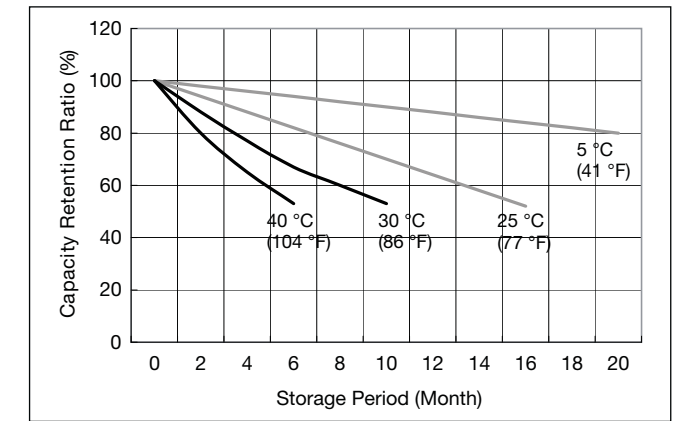

Constant-voltage and constant-current charge characteristics for Trickle use

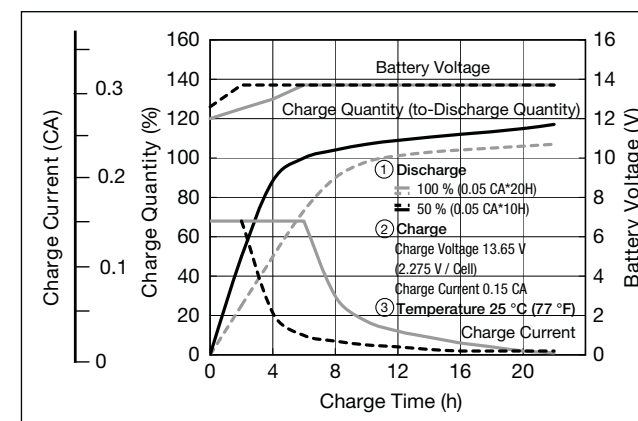

Discharge capacity by temperature and by discharge current

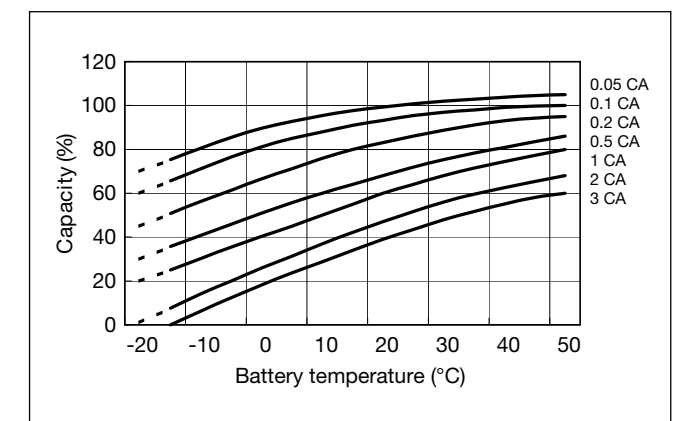

Discharge characteristics

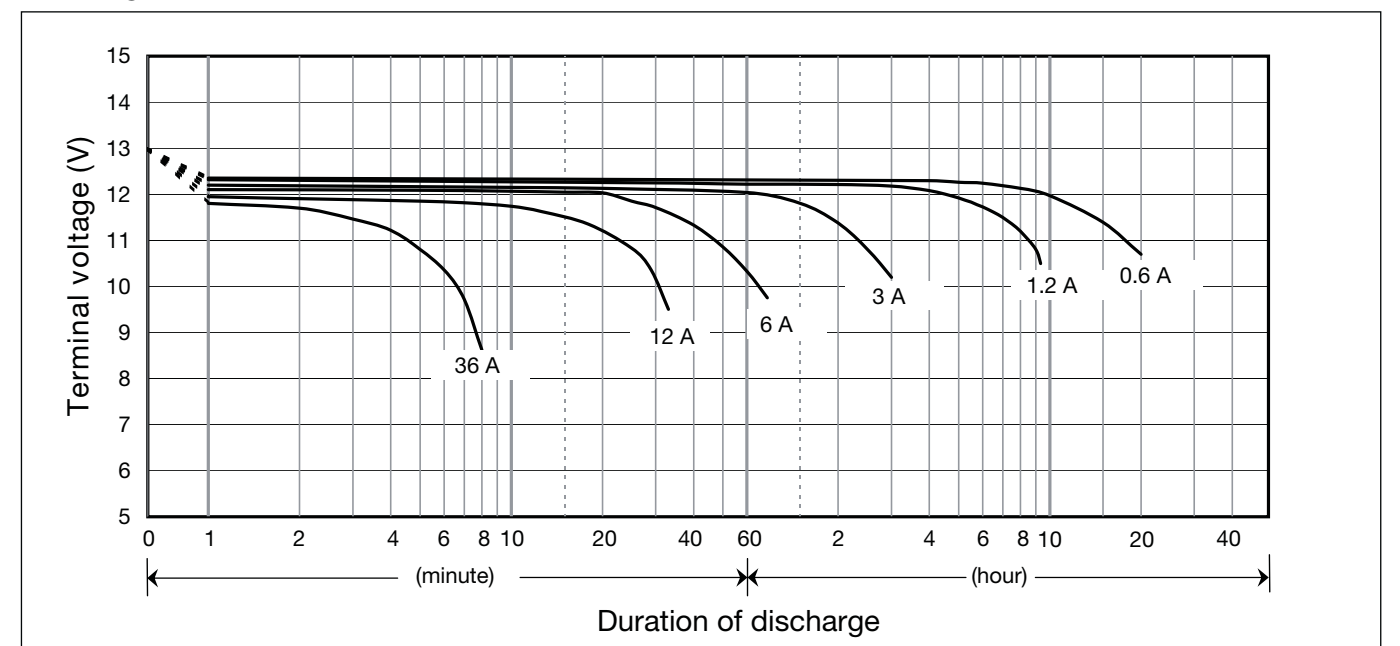

LC-XD1217PG/APG

For standby power supplies. Expected trickle design life:
10 – 12 years at 20°C according to Eurobat.

VdS

G104101



Dimensions (mm)

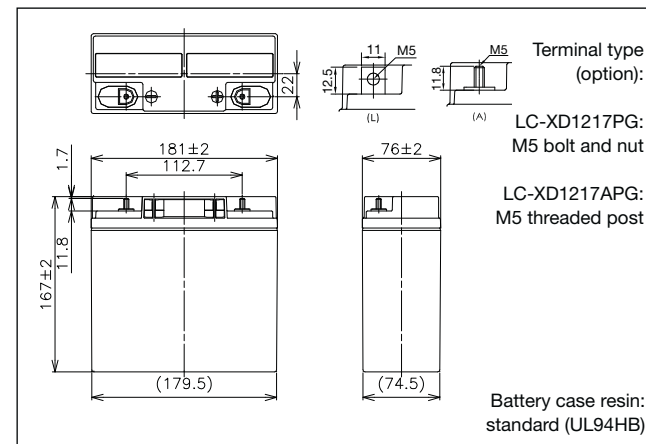

Specifications

Nominal voltage	12V	
Nominal capacity (20 hour rate)	17Ah	
Dimensions	Length	181mm
	Width	76mm
	Height	167mm
	Total Height	167mm
Approx. mass	6.5kg	
Terminal	M5 Bolt and Nut type/ M5 threaded post	

Duration of discharge vs Discharge current

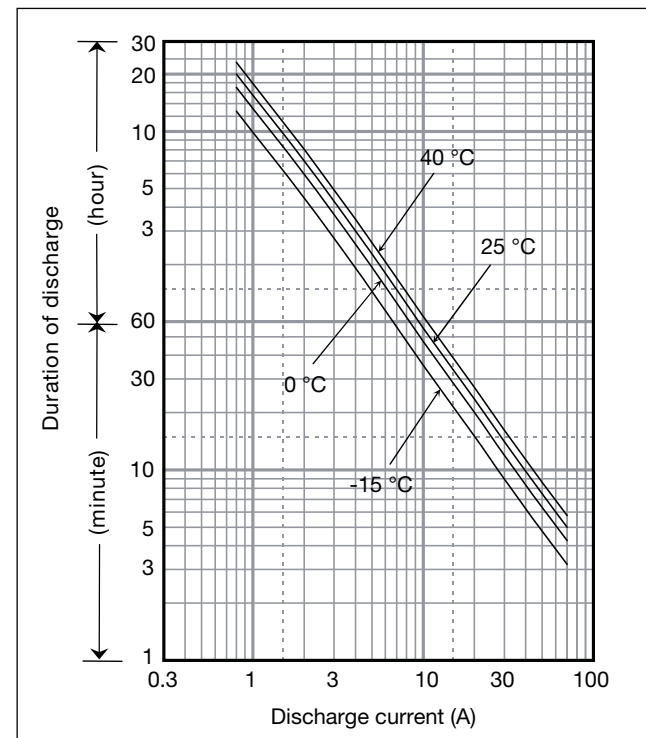

Characteristics

Capacity (25°C)	20 hour rate	17Ah
	10 hour rate	15Ah
	5 hour rate	13Ah
	1 hour rate	10Ah
Internal resistance	Fully charged battery (25°C)	12mΩ
Temperature dependency of capacity (20 hour rate)	40°C	102%
	25°C	100%
	0°C	85%
	-15°C	65%
Self discharge (25°C)	After 3 months	91%
	After 6 months	82%
	After 12 months	64%

Watt Table

Cut-off V	(Wattage/Battery)																							
	3min	5min	10min	15min	20min	30min	45min	1h	1.5h	2h	3h	4h	5h	6h	10h	20h	24h							
9.6V	1021	806	526	402	337	251	177	142	97.6	75.5	56.2	43.2	35.6	28.6	19.0	10.3	8.58							
9.9V	948	756	516	399	331	249	176	142	95.6	74.9	55.9	42.9	35.4	28.5	18.9	10.3	8.56							
10.2V	874	708	502	391	326	246	175	139	93.7	73.0	55.4	42.6	35.1	28.3	18.7	10.2	8.53							
10.5V	777	634	465	364	309	240	172	136	91.7	70.4	54.5	42.3	34.8	28.0	18.6	10.2	8.50							
10.8V	656	561	415	339	301	232	169	134	89.2	67.1	53.4	41.8	33.9	27.5	18.4	10.1	8.44							

Ampere Table

Cut-off V	(Ampere/Battery)																							
	3min	5min	10min	15min	20min	30min	45min	1h	1.5h	2h	3h	4h	5h	6h	10h	20h	24h							
9.6V	91.8	72.2	47.0	34.9	29.0	21.5	15.1	12.0	8.26	6.37	4.72	3.61	2.97	2.39	1.58	0.86	0.72							
9.9V	85.2	67.8	46.0	34.7	28.6	21.2	15.0	12.0	8.10	6.33	4.70	3.59	2.95	2.38	1.57	0.85	0.71							
10.2V	78.6	63.5	44.9	34.0	28.1	21.0	14.9	11.8	7.93	6.16	4.65	3.57	2.93	2.36	1.56	0.85	0.71							
10.5V	69.9	56.9	41.6	31.6	26.7	20.5	14.6	11.6	7.77	5.95	4.58	3.54	2.90	2.33	1.55	0.85	0.71							
10.8V	59.0	50.3	37.1	29.5	26.0	19.8	14.4	11.3	7.56	5.67	4.49	3.49	2.83	2.29	1.53	0.85	0.70							

Charging Method

Trickle use	Control voltage: 13.6 - 13.8V; Initial current: 2.55A or smaller
-------------	---

Influence of Temperature on Trickle life

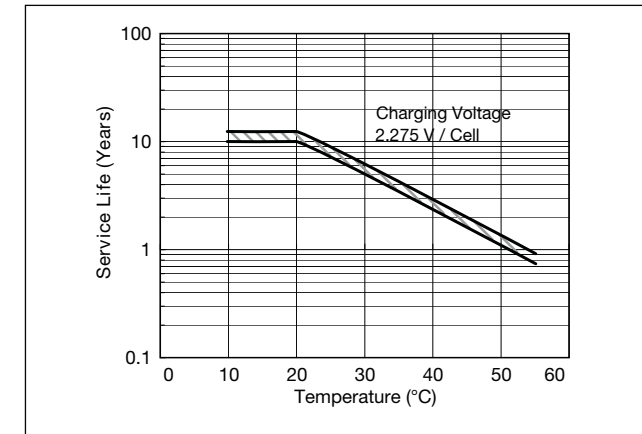

Cut off voltage

Discharge current	0.85A - 3.4A	3.4A - 8.5A	8.5A - 17A	17A - 34A	34A - 51A
Cut off voltage (V)	10.5	10.2	9.9	9.3	8.7

Residual capacity vs storage period

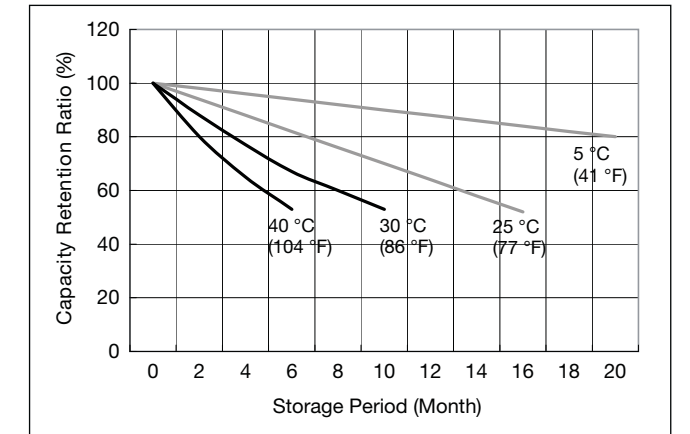

Constant-voltage and constant-current charge characteristics for Trickle use

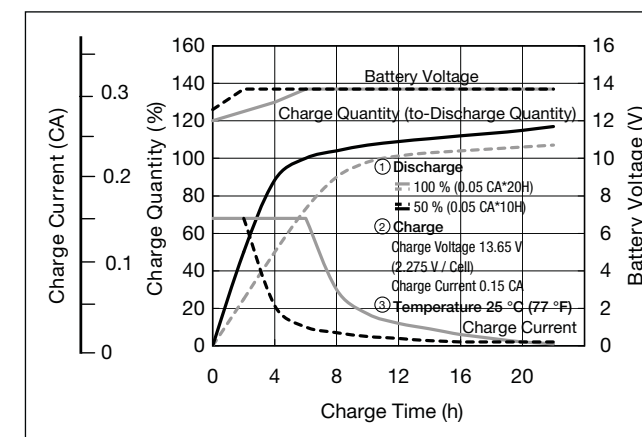

Discharge capacity by temperature and by discharge current

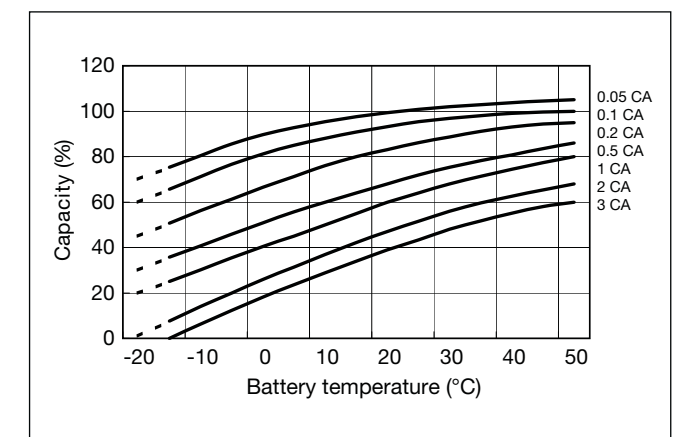

Discharge characteristics

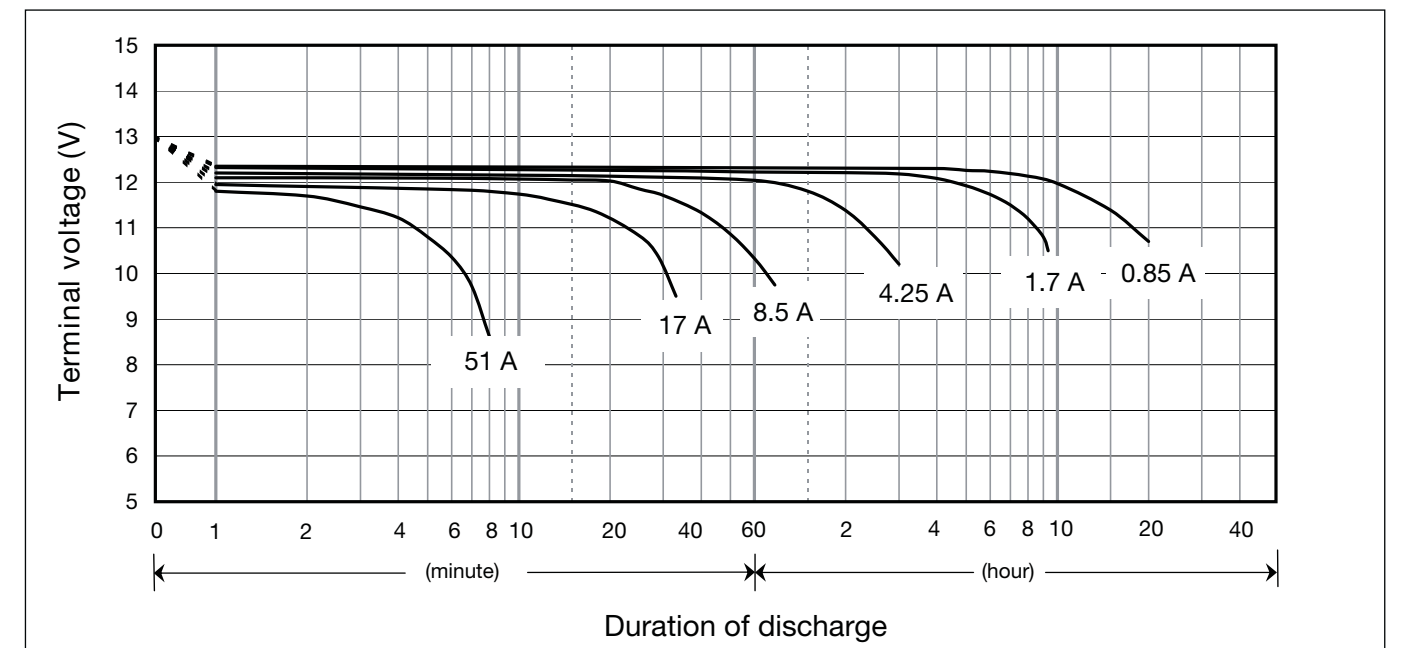

LC-X1220P/AP*1

For standby power supplies.
Expected trickle design life: 10 – 12 years at 20°C according to Eurobat.



Dimensions (mm)

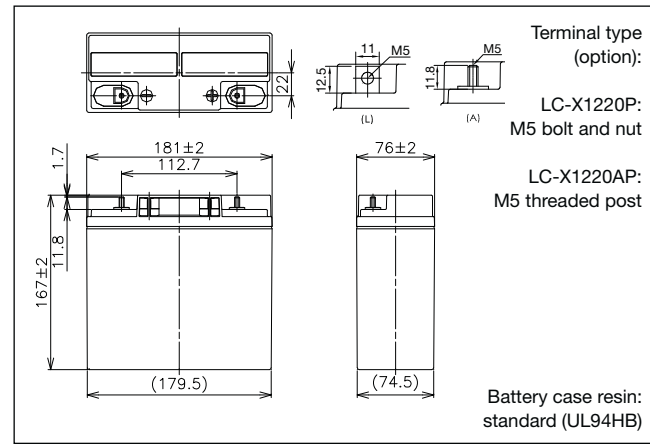

Specifications

Nominal voltage	12V	
Nominal capacity (20 hour rate)	20Ah	
Dimensions	Length	181mm
	Width	76mm
	Height	167mm
	Total Height	167mm
Approx. mass	6.6kg	
Terminal	M5 Bolt and Nut type/ M5 threaded post	

Characteristics

Capacity (25°C)	20 hour rate	20Ah
	10 hour rate	18Ah
	5 hour rate	16Ah
	1 hour rate	12Ah
Internal resistance	Fully charged battery (25°C)	11mΩ
Temperature dependency of capacity (20 hour rate)	40°C	102%
	25°C	100%
	0°C	85%
	-15°C	65%
Self discharge (25°C)	After 3 months	91%
	After 6 months	82%
	After 12 months	64%

Duration of discharge vs Discharge current

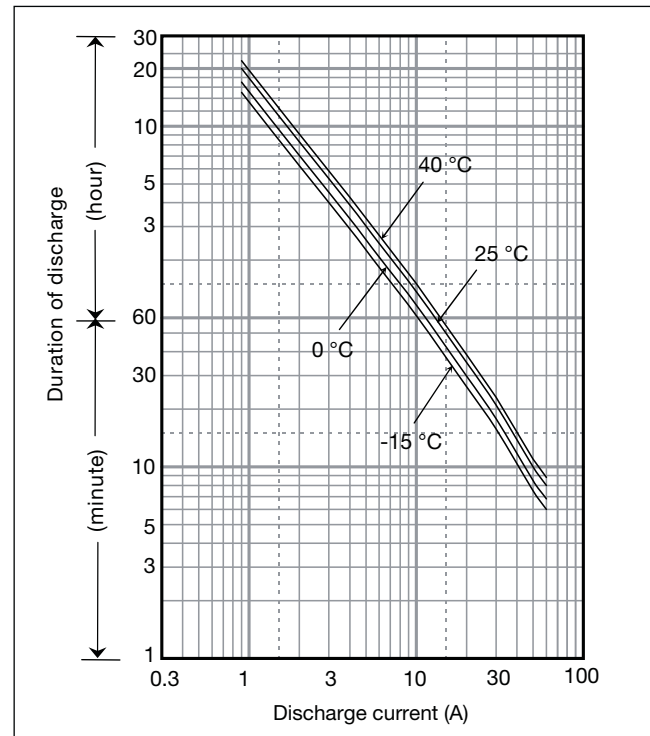

Watt Table

Cut-off V	(Wattage/Battery)																
	3min	5min	10min	15min	20min	30min	45min	1h	1.5h	2h	3h	4h	5h	6h	10h	20h	24h
9.6V	1202	948	619	473	396	296	209	167	115	88.8	66.1	50.8	41.9	33.7	22.3	12.1	10.1
9.9V	1115	889	607	470	390	293	207	167	113	88.1	65.8	50.5	41.6	33.6	22.2	12.1	10.1
10.2V	1029	833	591	460	383	289	205	164	110	85.8	65.1	50.1	41.3	33.3	22.0	12.0	10.0
10.5V	914	746	548	428	364	283	202	160	108	82.9	64.1	49.8	40.9	32.9	21.9	12.0	10.0
10.8V	772	660	488	399	354	273	199	157	105	78.9	62.8	49.1	39.9	32.4	21.7	11.9	9.93

Ampere Table

Cut-off V	(Ampere/Battery)																
	3min	5min	10min	15min	20min	30min	45min	1h	1.5h	2h	3h	4h	5h	6h	10h	20h	24h
9.6V	108	85.0	55.3	41.1	34.2	25.3	17.8	14.2	9.72	7.50	5.56	4.25	3.50	2.81	1.86	1.01	0.84
9.9V	100	79.7	54.2	40.8	33.6	25.0	17.7	14.2	9.53	7.44	5.53	4.22	3.47	2.80	1.85	1.01	0.84
10.2V	92.5	74.7	52.8	40.0	33.1	24.7	17.5	13.9	9.33	7.25	5.47	4.19	3.44	2.78	1.83	1.00	0.84
10.5V	82.2	66.9	48.9	37.2	31.4	24.2	17.2	13.6	9.14	7.00	5.39	4.17	3.42	2.74	1.83	1.00	0.83
10.8V	69.4	59.2	43.6	34.7	30.6	23.3	16.9	13.3	8.89	6.67	5.28	4.11	3.33	2.70	1.81	0.99	0.83

*1 This battery is also available with a flame retardant battery case resin (UL94 V-0).

Charging Method

Trickle use Control voltage: 13.6 - 13.8V; Initial current: 3A or smaller

Influence of Temperature on Trickle life

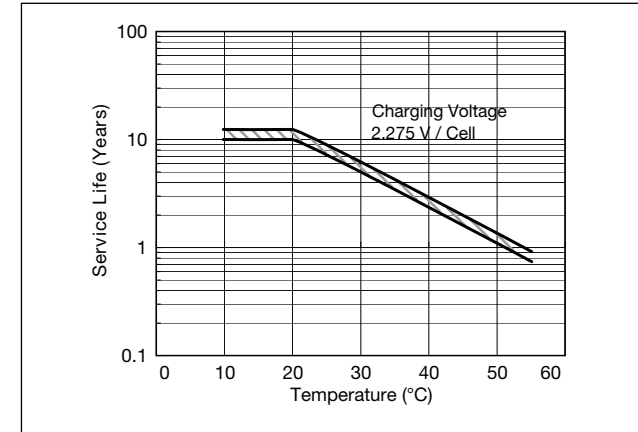

Cut off voltage

Discharge current	1A - 4A	4A - 10A	10A - 20A	20A - 40A	40A - 60A
Cut off voltage (V)	10.5	10.2	9.9	9.3	8.7

Residual capacity vs storage period

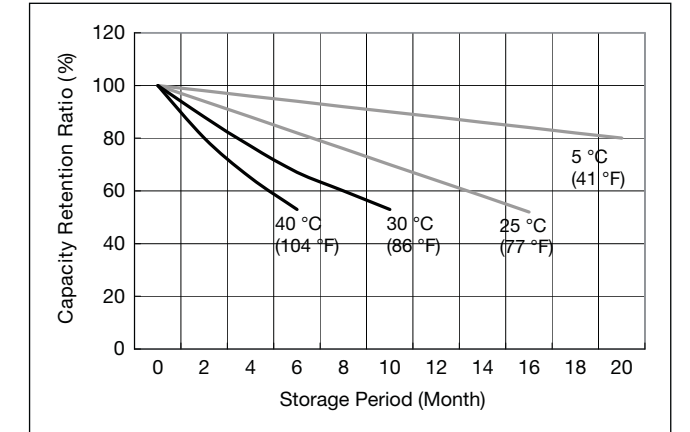

Constant-voltage and constant-current charge characteristics for Trickle use

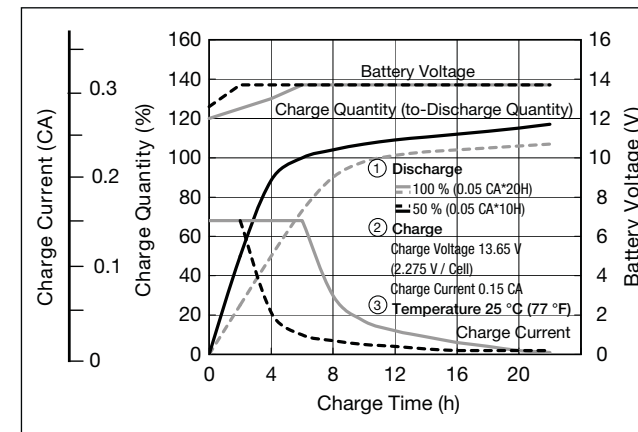

Discharge capacity by temperature and by discharge current

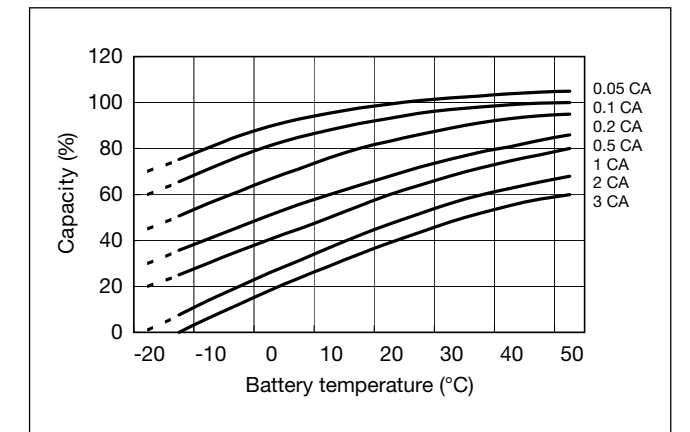

Discharge characteristics

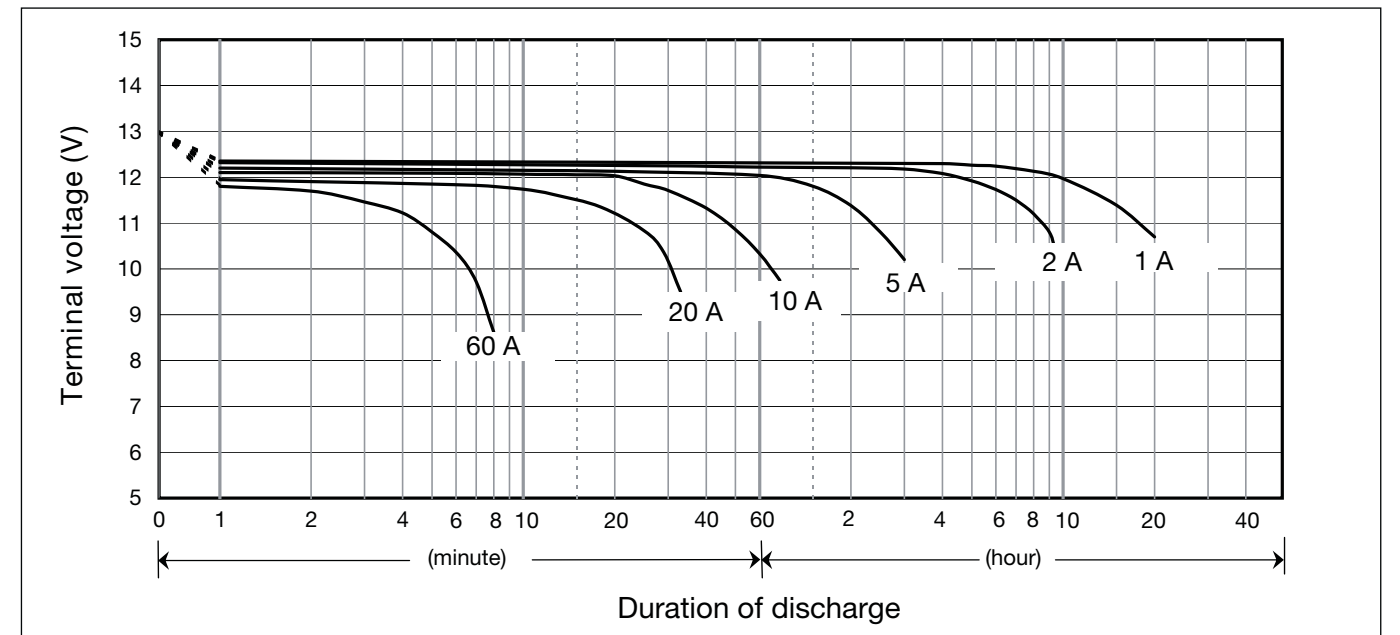

LC-X1224PG/APG

For standby power supplies. Expected trickle design life: 10 – 12 years at 20°C according to Eurobat.

VdS

G198049

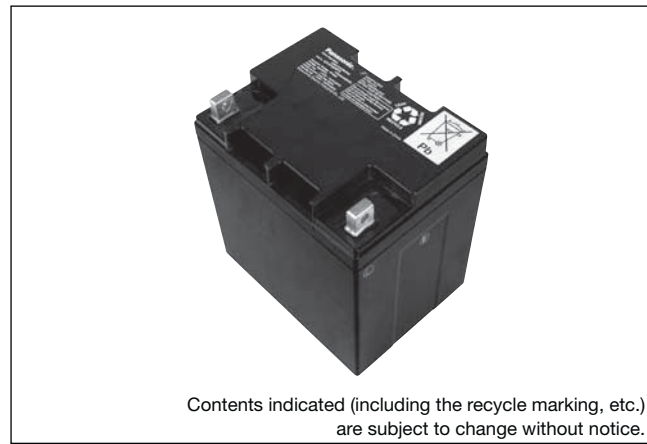

Dimensions (mm)

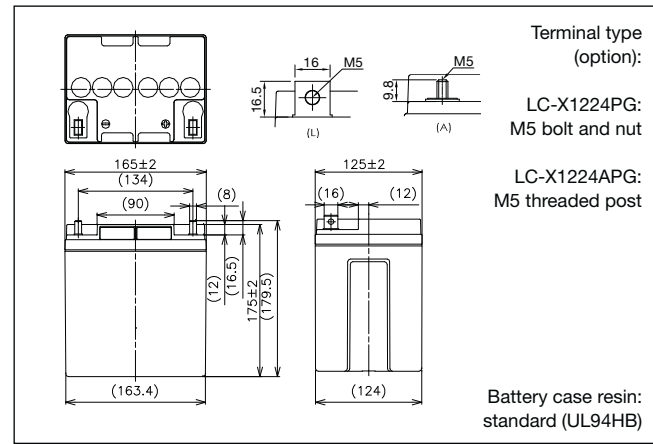

Specifications

Nominal voltage	12V	
Nominal capacity (20 hour rate)	24Ah	
Dimensions	Length	165mm
	Width	125mm
	Height	175mm
	Total Height	LC-X1224PG: 179.5mm LC-X1224APG: 175mm
Approx. mass	9kg	
Terminal	M5 Bolt and Nut type/ M5 threaded post	

Duration of discharge vs Discharge current

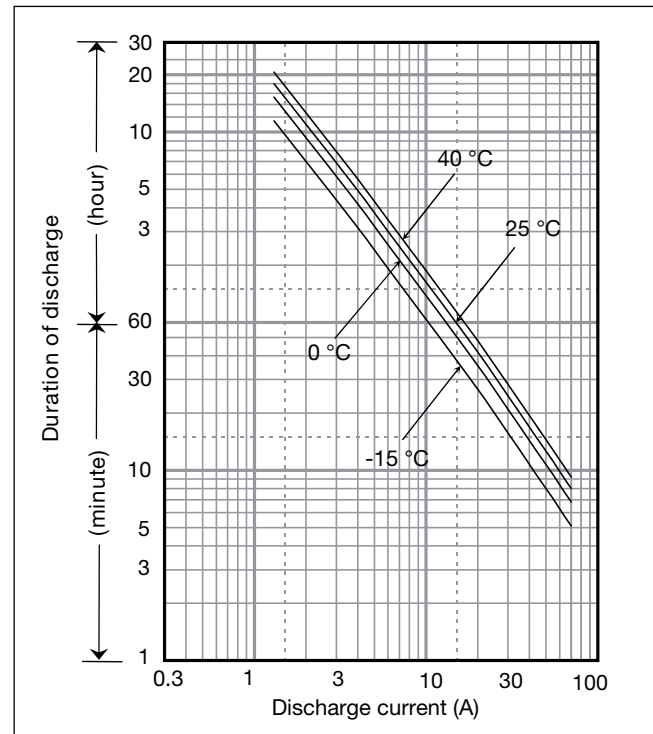

Characteristics

Capacity (25°C)	20 hour rate	24Ah
	10 hour rate	22Ah
	5 hour rate	19Ah
	1 hour rate	14Ah
Internal resistance	Fully charged battery (25°C)	11mΩ
Temperature dependency of capacity (20 hour rate)	40°C	102%
	25°C	100%
	0°C	85%
	-15°C	65%
Self discharge (25°C)	After 3 months	91%
	After 6 months	82%
	After 12 months	64%

Watt Table

Cut-off V	(Wattage/Battery)																
	3min	5min	10min	15min	20min	30min	45min	1h	1.5h	2h	3h	4h	5h	6h	10h	20h	24h
9.6V	1290	992	739	523	441	317	234	183	118	104	73.8	58.6	47.9	40.8	26.4	14.6	12.0
9.9V	1197	931	724	520	434	314	232	183	116	103	73.4	58.2	47.5	40.6	26.3	14.6	12.0
10.2V	1104	872	706	509	426	310	230	179	113	101	72.7	57.8	47.2	40.3	26.0	14.6	11.9
10.5V	982	782	654	474	405	303	226	175	111	97.2	71.6	57.4	46.8	39.8	25.9	14.4	11.9
10.8V	829	691	583	442	394	293	223	172	108	92.6	70.1	56.6	45.6	39.2	25.6	14.3	11.8

Ampere Table

Cut-off V	(Ampere/Battery)																
	3min	5min	10min	15min	20min	30min	45min	1h	1.5h	2h	3h	4h	5h	6h	10h	20h	24h
9.6V	116	89.0	66.0	45.5	38.0	27.1	19.9	15.5	10.0	8.80	6.20	4.90	4.00	3.40	2.20	1.22	1.00
9.9V	108	83.5	64.7	45.2	37.4	26.8	19.8	15.5	9.80	8.73	6.17	4.87	3.97	3.39	2.19	1.22	1.00
10.2V	99.3	78.2	63.0	44.3	36.8	26.5	19.6	15.2	9.60	8.51	6.11	4.84	3.94	3.36	2.17	1.21	0.99
10.5V	88.3	70.1	58.4	41.2	34.9	25.9	19.3	14.9	9.40	8.21	6.01	4.80	3.90	3.32	2.16	1.20	0.99
10.8V	74.6	62.0	52.1	38.4	34.0	25.0	19.0	14.6	9.14	7.82	5.89	4.74	3.81	3.27	2.13	1.19	0.98

Charging Method

Trickle use	Control voltage: 13.6 - 13.8V; Initial current: 3.6A or smaller
-------------	---

Influence of Temperature on Trickle life

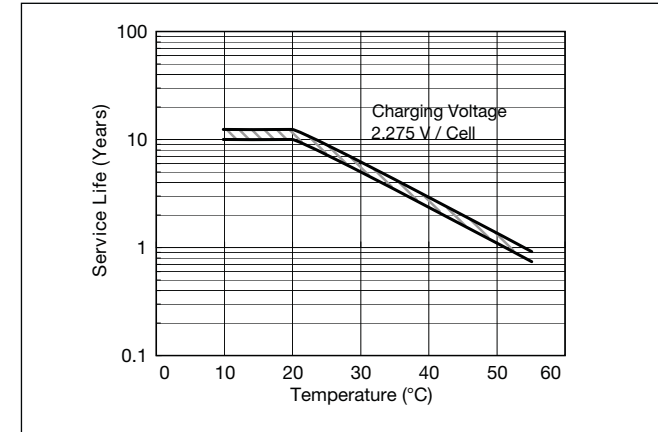

Cut off voltage

Discharge current	1.2A - 4.8A	4.8A - 12A	12A - 24A	24A - 48A	48A - 72A
Cut off voltage (V)	10.5	10.2	9.9	9.3	8.7

Residual capacity vs storage period

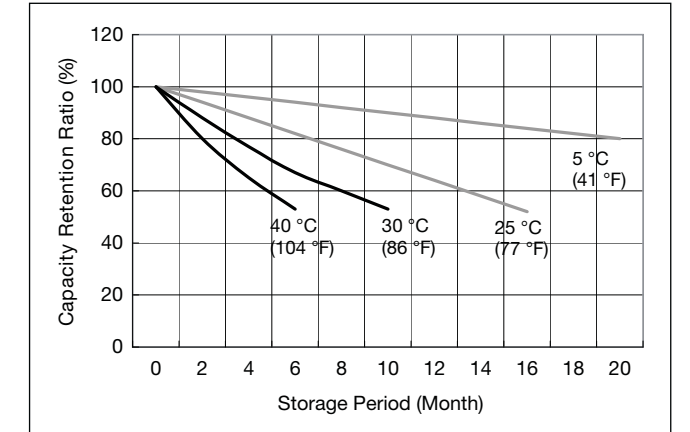

Constant-voltage and constant-current charge characteristics for Trickle use

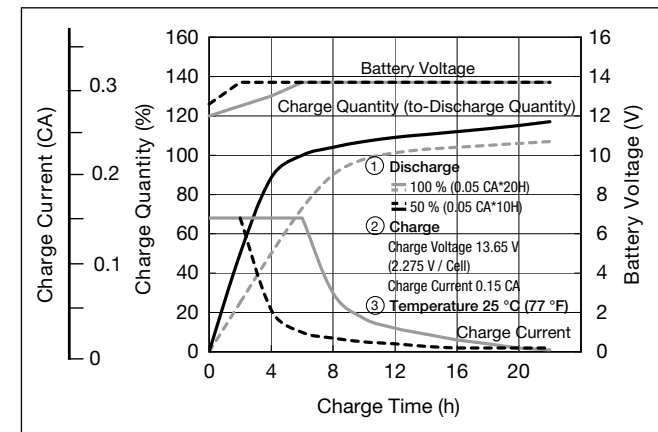

Discharge capacity by temperature and by discharge current

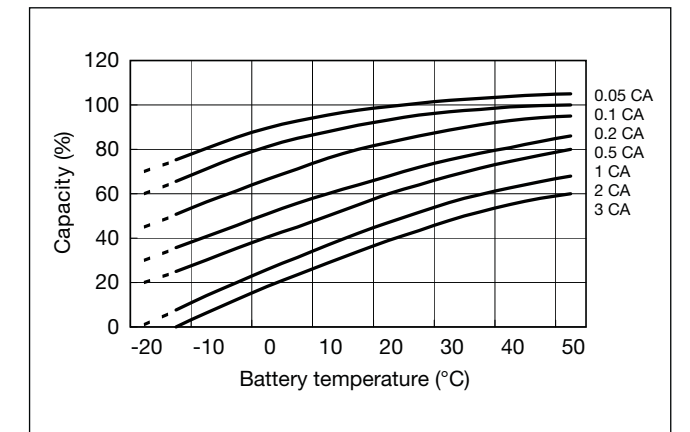

Discharge characteristics

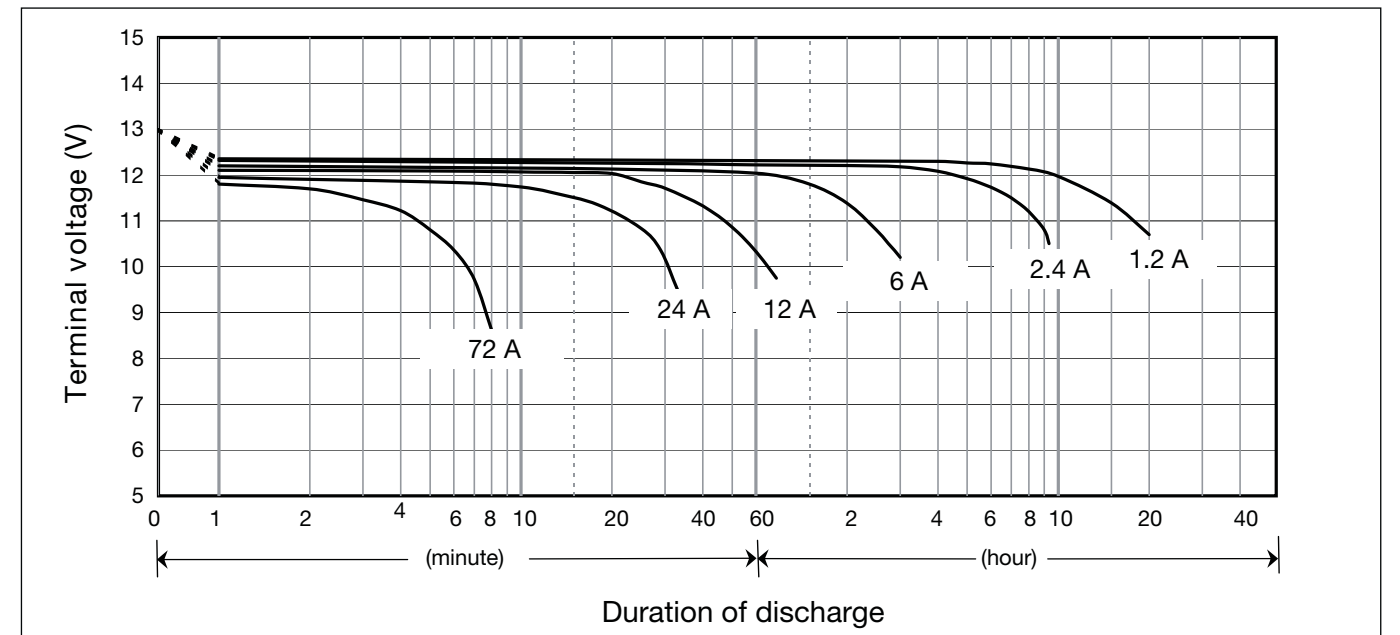

LC-X1228P/AP*1

For standby power supplies.
Expected trickle design life: 10 – 12 years at 20°C according to Eurobat.

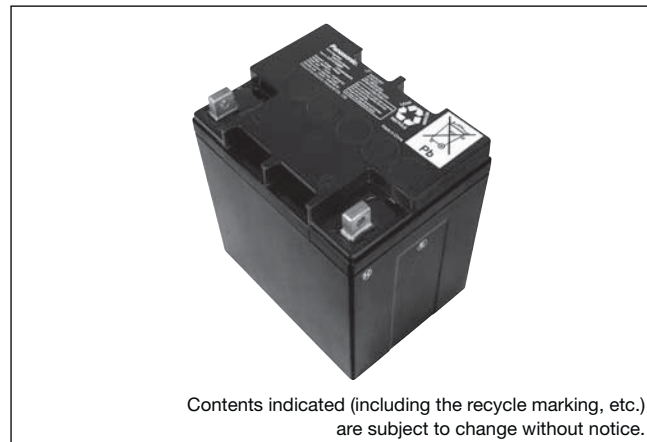

Dimensions (mm)

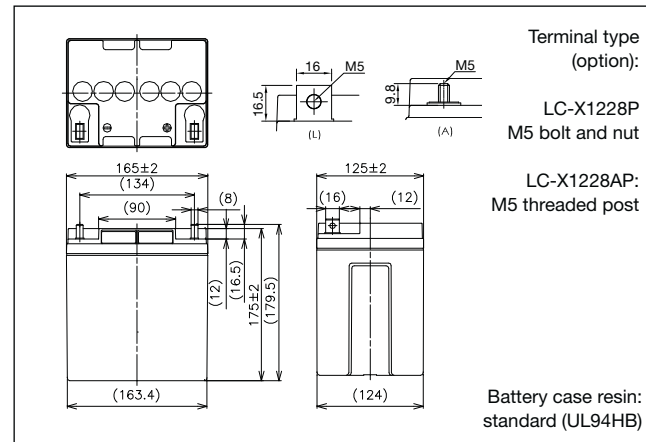

Specifications

Nominal voltage	12V	
Nominal capacity (20 hour rate)	28Ah	
Dimensions	Length	165mm
	Width	125mm
	Height	175mm
	Total Height	LC-X1228P: 179.5mm LC-X1228AP: 175mm
Approx. mass	11kg	
Terminal	M5 Bolt and Nut type/ M5 threaded post	

Characteristics

Capacity (25°C)	20 hour rate	28.0Ah
	10 hour rate	26.5Ah
	5 hour rate	25.0Ah
	1 hour rate	21.0Ah
Internal resistance	Fully charged battery (25°C)	8mΩ
Temperature dependency of capacity (20 hour rate)	40°C	102%
	25°C	100%
	0°C	85%
	-15°C	65%
Self discharge (25°C)	After 3 months	91%
	After 6 months	82%
	After 12 months	64%

Duration of discharge vs Discharge current

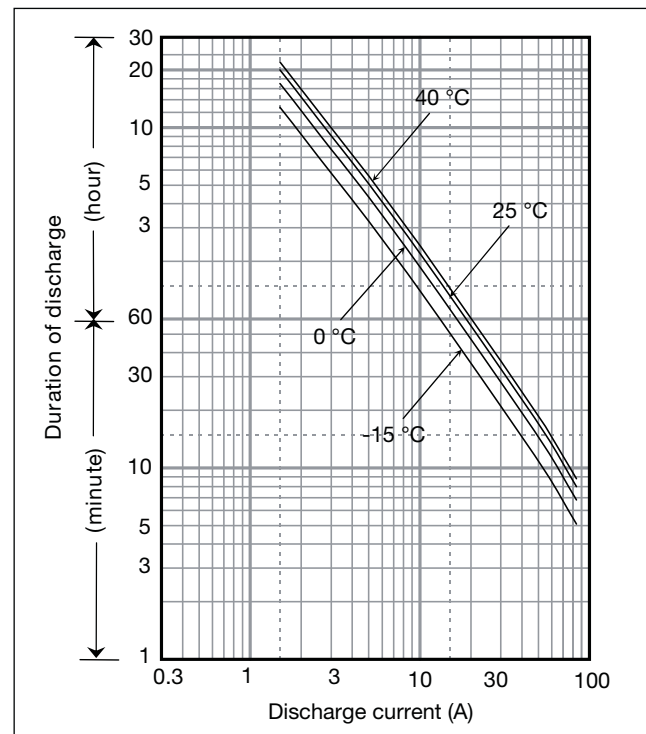

Watt Table

Cut-off V	(Wattage/Battery)																
	3min	5min	10min	15min	20min	30min	45min	1h	1.5h	2h	3h	4h	5h	6h	10h	20h	24h
9.6V	1423	1160	865	664	585	410	304	260	159	129	91.6	74.1	61.1	40.8	31.8	16.8	14.0
9.9V	1357	1093	849	654	579	404	294	254	156	128	90.4	72.9	59.9	51.6	31.8	16.8	14.0
10.2V	1301	1026	818	643	567	397	294	251	155	127	89.3	71.7	59.9	51.6	31.8	16.8	14.0
10.5V	1201	976	784	621	545	386	282	247	154	126	88.1	71.7	59.9	51.6	31.8	16.8	14.0
10.8V	1052	903	773	610	539	374	255	218	149	118	84.5	70.5	59.9	50.4	31.8	16.8	13.9

Ampere Table

Cut-off V	(Ampere/Battery)																
	3min	5min	10min	15min	20min	30min	45min	1h	1.5h	2h	3h	4h	5h	6h	10h	20h	24h
9.6V	128	104	77.2	57.7	50.4	35.0	25.9	22.1	13.5	10.9	7.7	6.2	5.1	3.4	2.65	1.40	1.17
9.9V	122	98.0	75.8	56.9	49.9	34.5	25.0	21.6	13.2	10.8	7.6	6.1	5.0	4.3	2.65	1.40	1.17
10.2V	117	92.0	73.0	55.9	48.9	33.9	25.0	21.3	13.1	10.7	7.5	6.0	5.0	4.3	2.65	1.40	1.17
10.5V	108	87.5	70.0	54.0	47.0	33.0	24.0	21.0	13.0	10.6	7.4	6.0	5.0	4.3	2.70	1.40	1.17
10.8V	94.6	81.0	69.0	53.0	46.5	32.0	21.7	18.5	12.6	10.0	7.1	5.9	5.0	4.2	2.65	1.40	1.16

*1 This battery is also available with a flame retardant battery case resin (UL94 V-0).

Charging Method

Trickle use	Control voltage: 13.6 - 13.8V; Initial current: 4.2A or smaller
-------------	---

Influence of Temperature on Trickle life

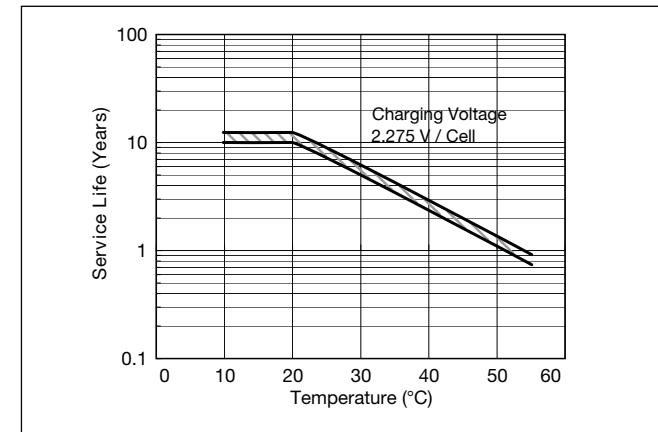

Cut off voltage

Discharge current	1.4A - 5.6A	5.6A - 14A	14A - 28A	28A - 56A	56A - 84A
Cut off voltage (V)	10.5	10.2	9.9	9.3	8.7

Residual capacity vs storage period

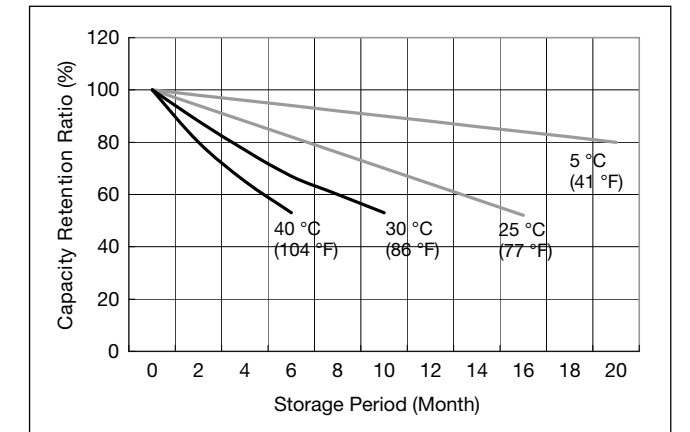

Constant-voltage and constant-current charge characteristics for Trickle use

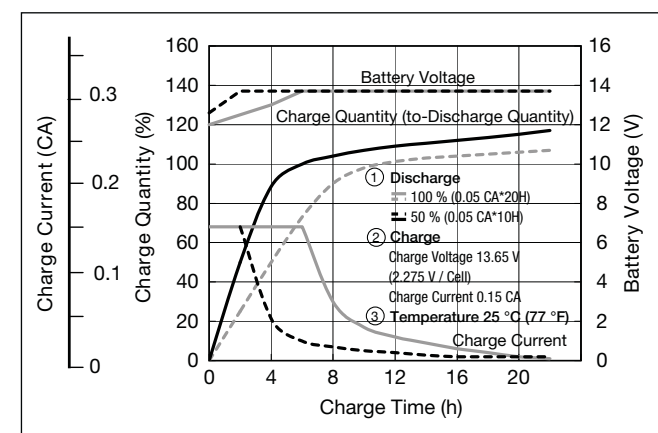

Discharge capacity by temperature and by discharge current

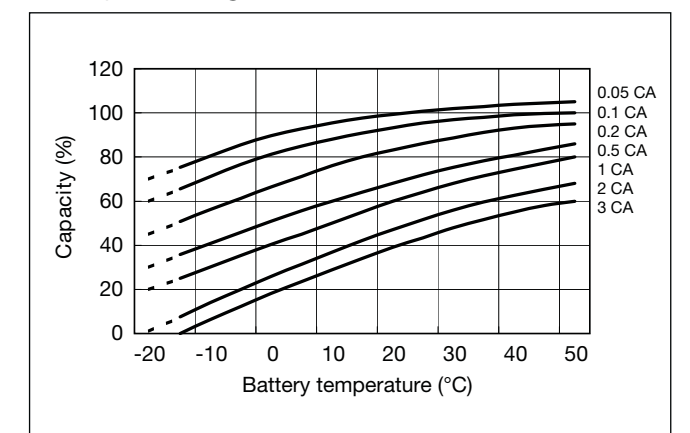

Discharge characteristics

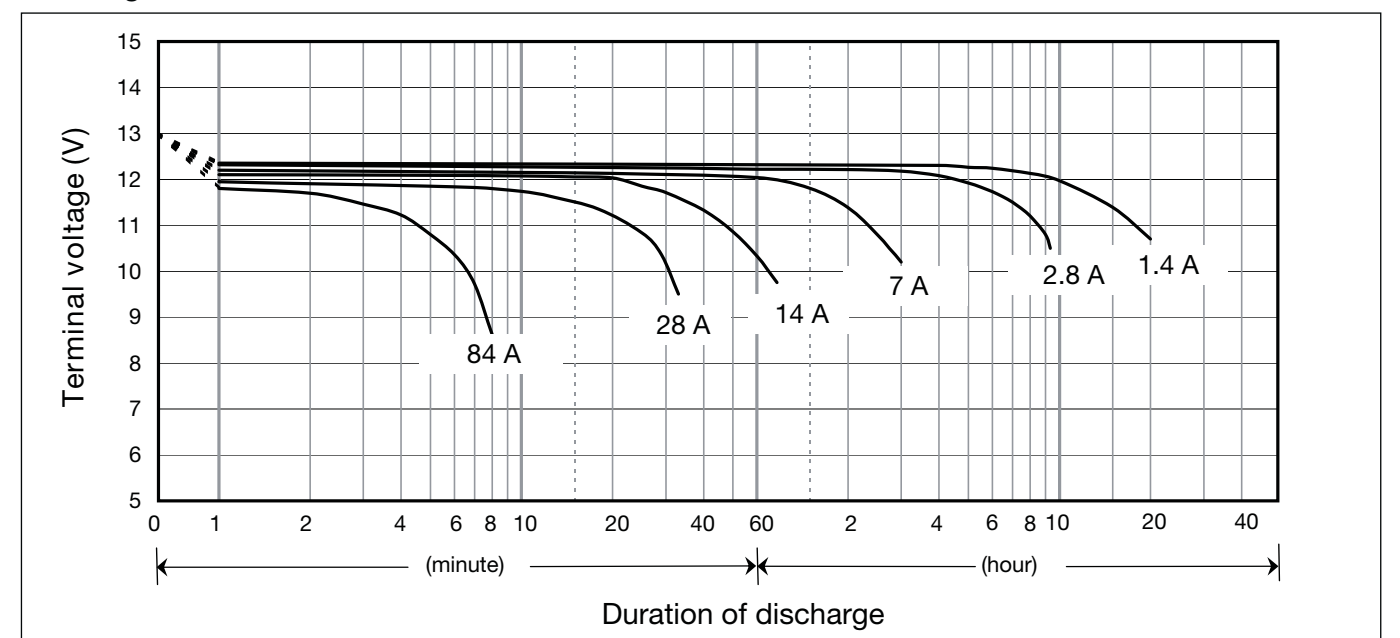

LC-X1238PG/APG

For standby power supplies. Expected trickle design life:
10 – 12 years at 20°C according to Eurobat.

VdS

G100002



Dimensions (mm)

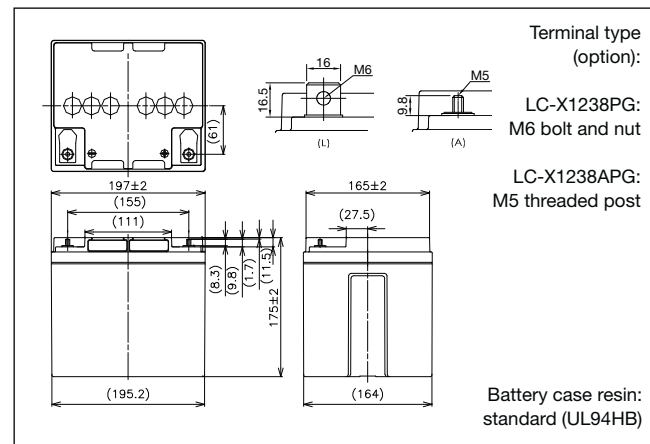

Specifications

Nominal voltage	12V	
Nominal capacity (20 hour rate)	38Ah	
Dimensions	Length	197mm
	Width	165mm
	Height	175mm
	Total Height	LC-X1238PG: 180mm LC-X1238APG: 175mm
Approx. mass	13kg	
Terminal	M6 Bolt and Nut type/ M5 threaded post	

Characteristics

Capacity (25°C)	20 hour rate	38.0Ah
	10 hour rate	35.0Ah
Internal resistance	Fully charged battery (25°C)	8mΩ
	Temperature dependency of capacity (20 hour rate)	40°C: 102% 25°C: 100% 0°C: 85% -15°C: 65%
Self discharge (25°C)	After 3 months	91%
	After 6 months	82%
	After 12 months	64%

Duration of discharge vs Discharge current

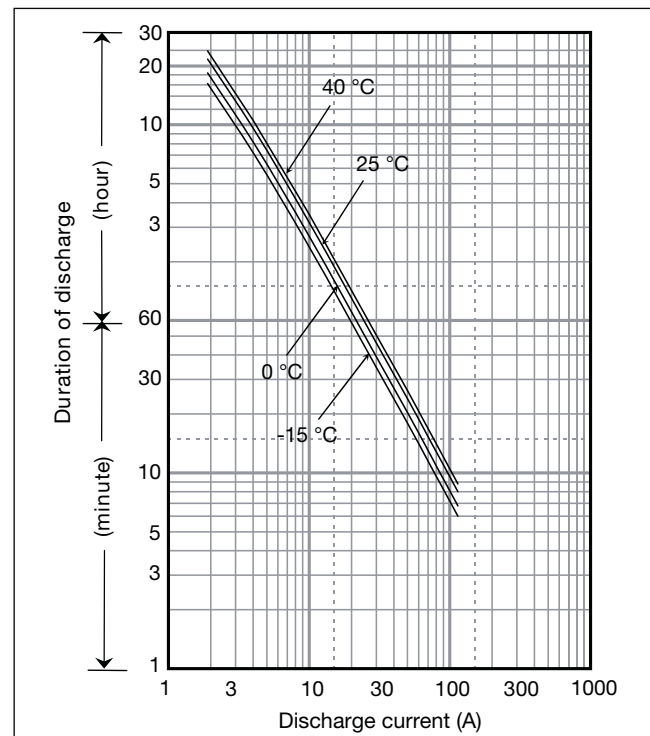

Watt Table

Cut-off V	(Wattage/Battery)																							
	3min	5min	10min	15min	20min	30min	45min	1h	1.5h	2h	3h	4h	5h	6h	10h	20h	24h							
9.6V	1668	1349	1030	800	686	505	351	276	214	169	123	99.2	77.9	68.3	42.0	22.8	19.0							
9.9V	1535	1271	1008	788	682	500	350	269	209	168	120	98.0	76.7	68.3	42.0	22.8	19.0							
10.2V	1457	1204	980	768	672	489	349	267	185	167	119	96.8	75.5	68.3	42.0	22.8	19.0							
10.5V	1446	1126	952	748	661	480	346	265	183	166	119	96.8	75.5	68.3	42.0	22.8	19.0							
10.8V	1311	1098	874	716	640	468	308	247	175	155	114	94.4	74.3	67.1	42.0	22.8	18.7							

Ampere Table

Cut-off V	(Ampere/Battery)																							
	3min	5min	10min	15min	20min	30min	45min	1h	1.5h	2h	3h	4h	5h	6h	10h	20h	24h							
9.6V	150	121	92.0	69.6	59.1	43.2	29.9	23.4	18.1	14.3	10.3	8.3	6.5	5.7	3.50	1.90	1.58							
9.9V	138	114	90.0	68.5	58.8	42.7	29.8	22.8	17.7	14.2	10.1	8.2	6.4	5.7	3.50	1.90	1.58							
10.2V	131	108	87.5	66.8	57.9	41.8	29.7	22.7	15.7	14.1	10.0	8.1	6.3	5.7	3.50	1.90	1.58							
10.5V	130	101	85.0	65.0	57.0	41.0	29.5	22.5	15.5	14.0	10.0	8.1	6.3	5.7	3.50	1.90	1.58							
10.8V	118	98.5	78.0	62.3	55.2	40.0	26.2	21.0	14.8	13.1	9.6	7.9	6.2	5.6	3.50	1.90	1.56							

Charging Method

Trickle use	Control voltage: 13.6 - 13.8V; Initial current: 5.7A or smaller
-------------	---

Influence of Temperature on Trickle life

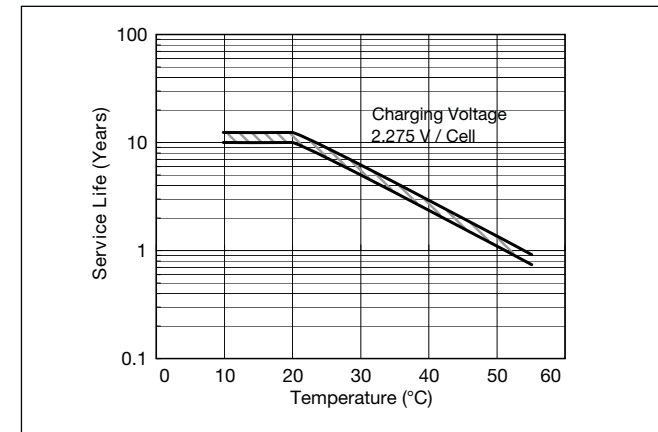

Cut off voltage

Discharge current	1.9A - 7.6A	7.6A - 19A	19A - 38A	38A - 76A	76A - 114A
Cut off voltage (V)	10.5	10.2	9.9	9.3	8.7

Residual capacity vs storage period

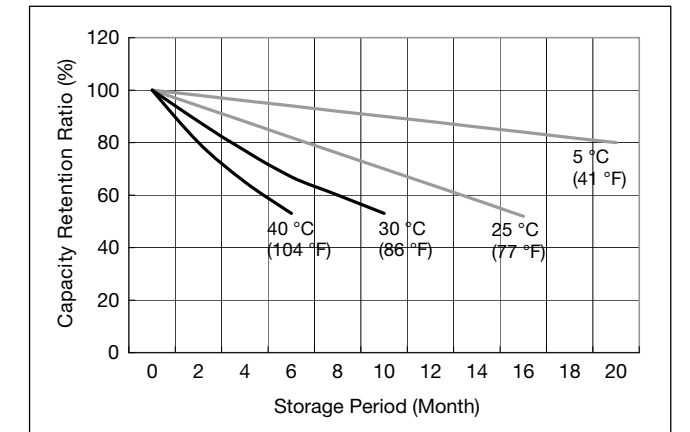

Constant-voltage and constant-current charge characteristics for Trickle use

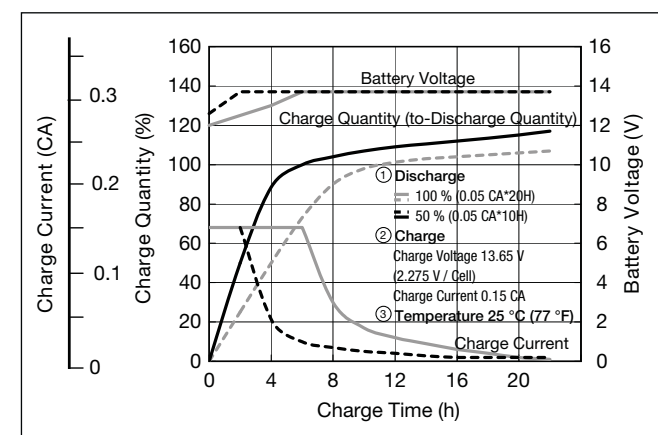

Discharge capacity by temperature and by discharge current

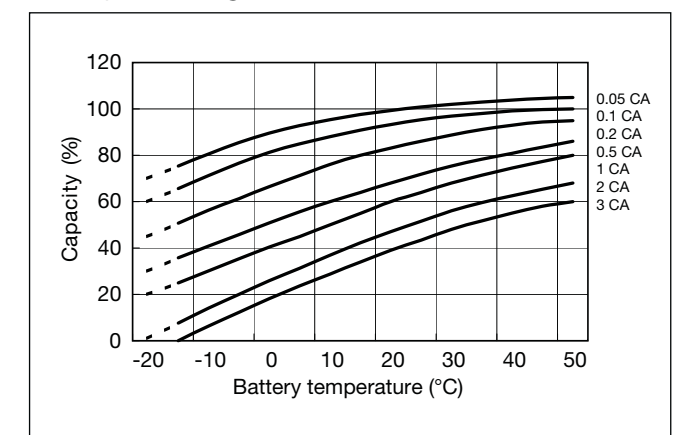

Discharge characteristics

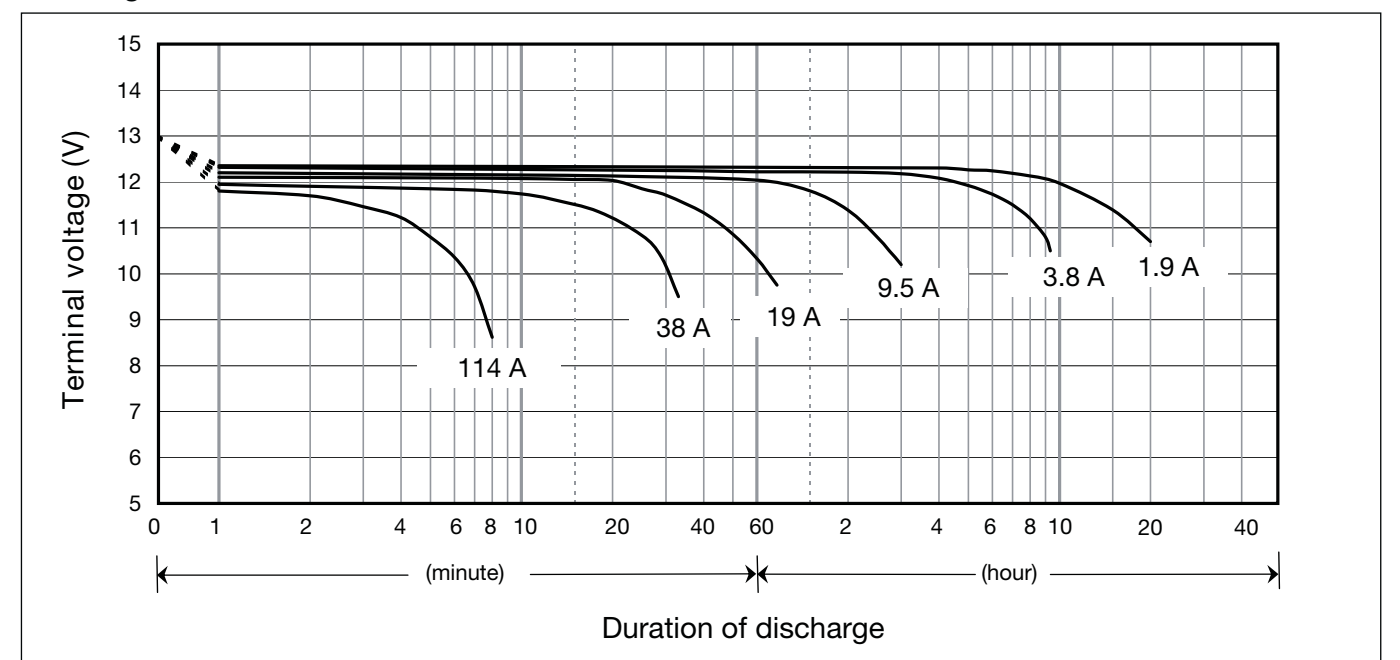

LC-X1242P/AP*1

For standby power supplies.
Expected trickle design life: 10 – 12 years at 20°C according to Eurobat.

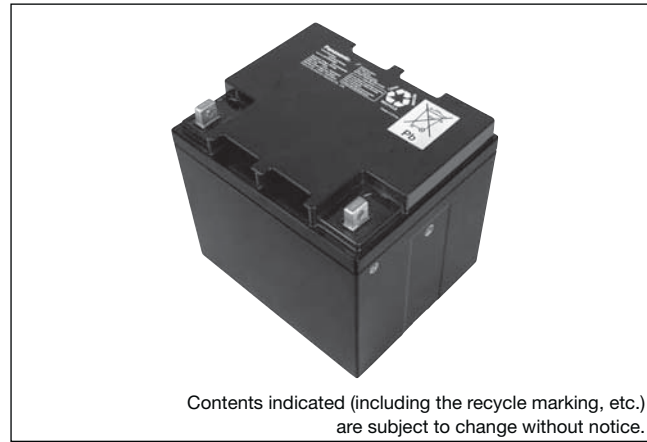

Dimensions (mm)

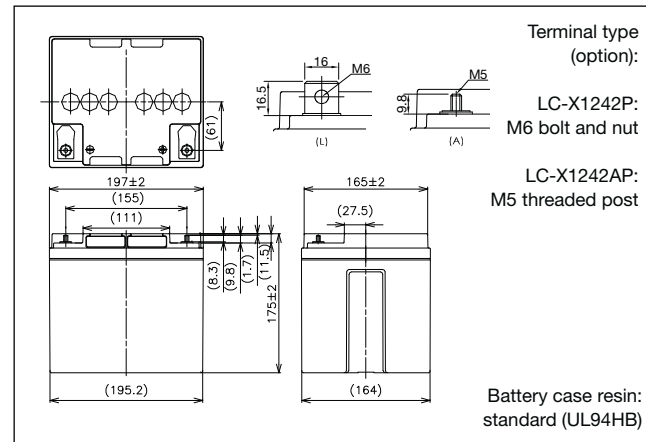

Specifications

Nominal voltage	12V	
Nominal capacity (20 hour rate)	42Ah	
Dimensions	Length	197mm
	Width	165mm
	Height	175mm
	Total Height	LC-X1242P: 180mm LC-X1242AP: 175mm
Approx. mass	16kg	
Terminal	M6 Bolt and Nut type/ M5 threaded post	

Characteristics

Capacity (25°C)	20 hour rate	42Ah
	10 hour rate	40Ah
	5 hour rate	37Ah
	1 hour rate	26Ah
Internal resistance	Fully charged battery (25°C)	8mΩ
Temperature dependency of capacity (20 hour rate)	40°C	102%
	25°C	100%
	0°C	85%
	-15°C	65%
Self discharge (25°C)	After 3 months	91%
	After 6 months	82%
	After 12 months	64%

Duration of discharge vs Discharge current

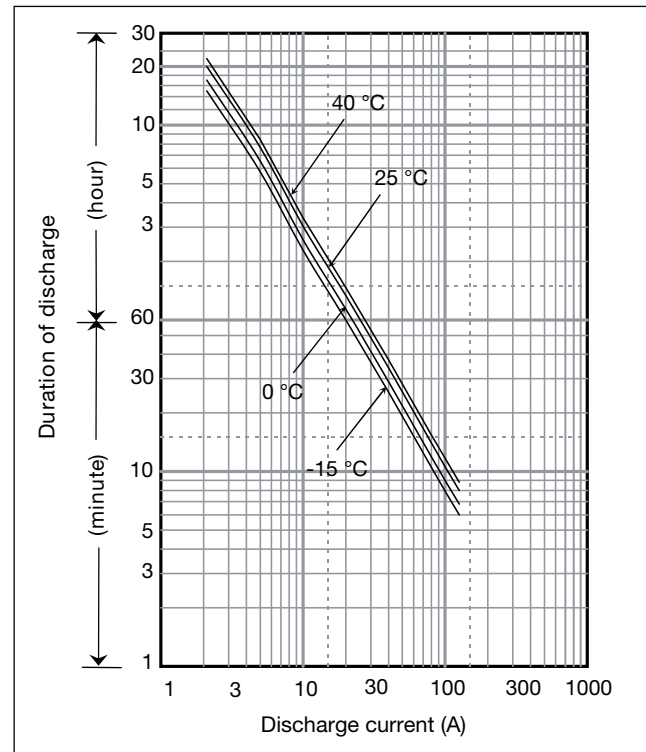

Watt Table

Cut-off V	(Wattage/Battery)																	
	3min	5min	10min	15min	20min	30min	45min	1h	1.5h	2h	3h	4h	5h	6h	10h	20h	24h	
9.6V	1846	1483	1254	966	835	625	410	312	241	187	132	110	89.9	79.1	48.0	25.2	21.0	
9.9V	1701	1405	1232	966	824	607	407	310	234	186	130	109	88.7	79.1	48.0	25.2	21.0	
10.2V	1612	1327	1210	943	812	596	406	307	217	184	127	108	88.7	77.9	48.0	25.2	21.0	
10.5V	1590	1249	1176	920	800	585	405	306	211	184	126	108	88.7	77.9	48.0	25.2	21.0	
10.8V	1449	1215	1086	886	777	573	390	295	201	173	121	105	87.5	75.5	48.0	25.2	20.8	

Ampere Table

Cut-off V	(Ampere/Battery)																	
	3min	5min	10min	15min	20min	30min	45min	1h	1.5h	2h	3h	4h	5h	6h	10h	20h	24h	
9.6V	166	133	112	84	72	53.4	34.9	26.5	20.4	15.8	11.1	9.2	7.5	6.6	4.0	2.1	1.75	
9.9V	153	126	110	84	71	51.9	34.7	26.3	19.8	15.7	10.9	9.1	7.4	6.6	4.0	2.1	1.75	
10.2V	145	119	108	82	70	50.9	34.6	26.1	18.4	15.5	10.7	9.0	7.4	6.5	4.0	2.1	1.75	
10.5V	143	112	105	80	69	50.0	34.5	26.0	17.9	15.5	10.6	9.0	7.4	6.5	4.0	2.1	1.75	
10.8V	130	109	97	77	67	49.0	33.2	25.0	17.0	14.6	10.2	8.8	7.3	6.3	4.0	2.1	1.73	

*1 This battery is also available with a flame retardant battery case resin (UL94 V-0).

Charging Method

Trickle use Control voltage: 13.6 - 13.8V; Initial current: 6.3A or smaller

Influence of Temperature on Trickle life

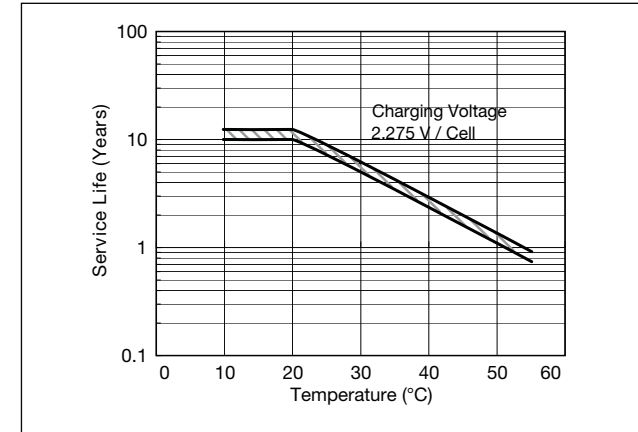

Cut off voltage

Discharge current	2.1A - 8.4A	8.4A - 21A	21A - 42A	42A - 84A	84A - 126A
Cut off voltage (V)	10.5	10.2	9.9	9.3	8.7

Residual capacity vs storage period

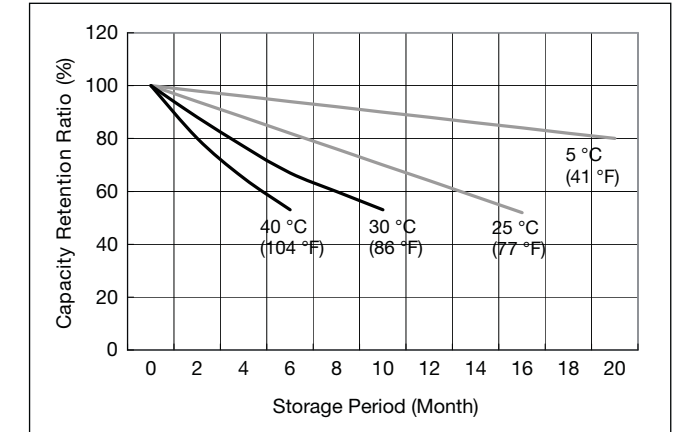

Constant-voltage and constant-current charge characteristics for Trickle use

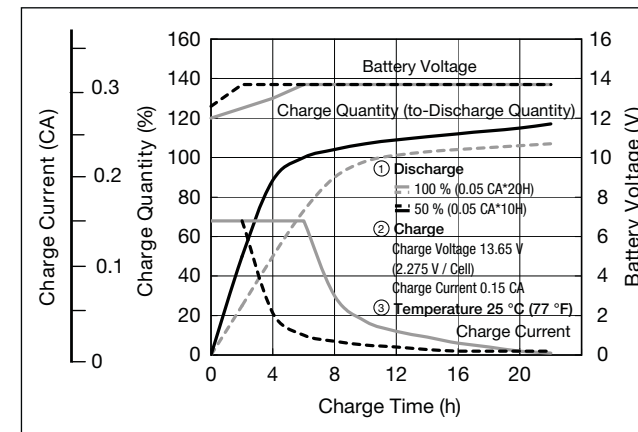

Discharge capacity by temperature and by discharge current

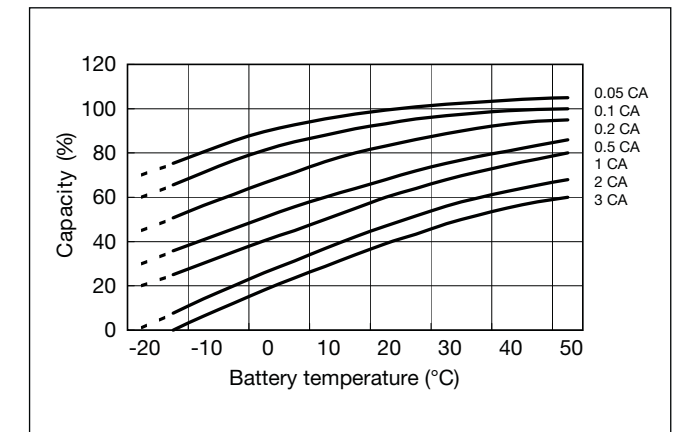

Discharge characteristics

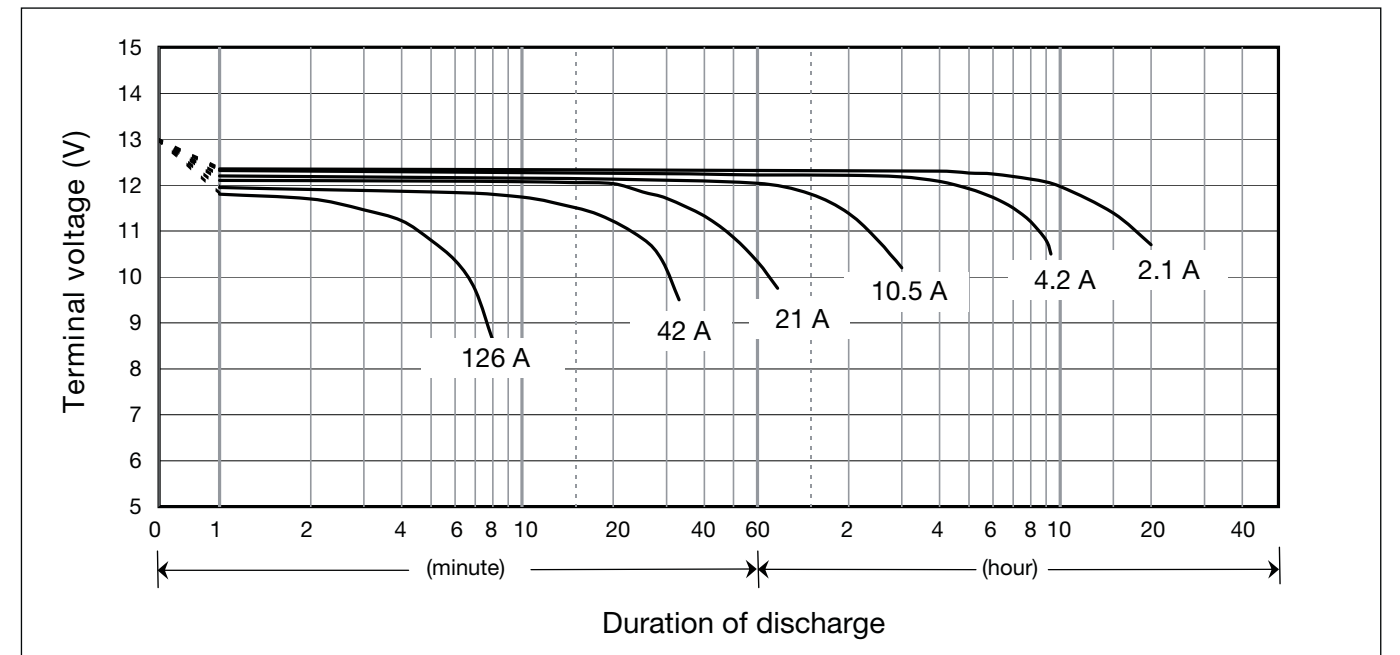

LC-X1265PG

For standby power supplies. Expected trickle design life: 10 – 12 years at 20°C according to Eurobat.

VdS

G199090



Dimensions (mm)

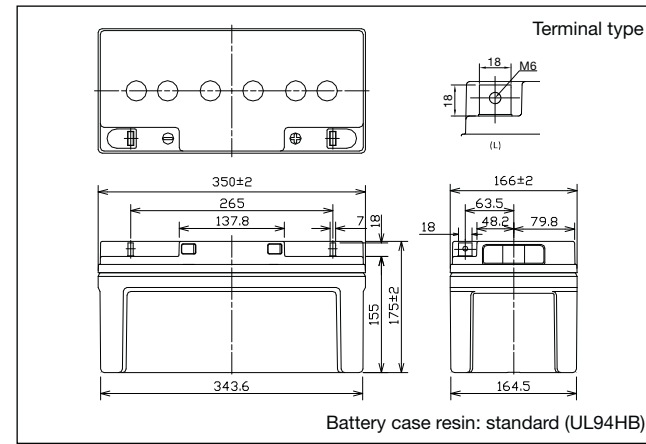

Specifications

Nominal voltage	12V	
Nominal capacity (20 hour rate)	65Ah	
Dimensions	Length	350mm
	Width	166mm
	Height	175mm
	Total Height	175mm
Approx. mass	20kg	
Terminal	M6 Bolt and Nut type	

Duration of discharge vs Discharge current

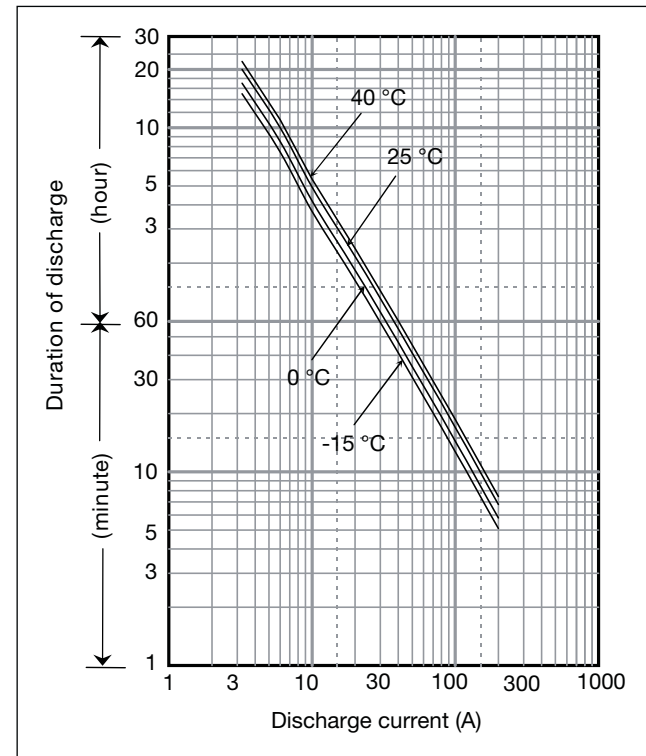

Characteristics

Capacity (25°C)	20 hour rate	65Ah
	10 hour rate	59Ah
	5 hour rate	53Ah
	1 hour rate	40Ah
Internal resistance	Fully charged battery (25°C)	7mΩ
Temperature dependency of capacity (20 hour rate)	40°C	102%
	25°C	100%
	0°C	85%
	-15°C	65%
Self discharge (25°C)	After 3 months	91%
	After 6 months	82%
	After 12 months	64%

Watt Table

Cut-off V	(Wattage/Battery)																		
	3min	5min	10min	15min	20min	30min	45min	1h	1.5h	2h	3h	4h	5h	6h	10h	20h	24h		
9.6V	2235	1884	1439	1127	956	742	533	501	321	290	201	158	131	115	70.8	39.0	32.4		
9.9V	2180	1851	1422	1116	951	734	520	494	313	289	198	157	127	115	70.8	39.0	32.4		
10.2V	2010	1735	1386	1093	935	725	515	484	307	281	196	156	126	114	70.1	38.9	32.3		
10.5V	1787	1554	1284	1017	888	709	507	474	300	272	193	154	125	113	69.7	38.8	32.2		
10.8V	1509	1374	1145	949	865	685	499	465	292	259	189	152	122	111	69.0	38.6	32.0		

Ampere Table

Cut-off V	(Ampere/Battery)																		
	3min	5min	10min	15min	20min	30min	45min	1h	1.5h	2h	3h	4h	5h	6h	10h	20h	24h		
9.6V	201	169	129	98.0	82.4	63.4	45.4	42.5	27.2	24.5	16.9	13.2	10.9	9.6	5.90	3.25	2.70		
9.9V	196	166	127	97.0	82.0	62.7	44.3	41.9	26.5	24.4	16.6	13.1	10.6	9.6	5.90	3.25	2.70		
10.2V	181	156	124	95.0	80.6	62.0	43.9	41.1	26.0	23.8	16.4	13.0	10.5	9.5	5.84	3.24	2.69		
10.5V	161	139	115	88.4	76.6	60.6	43.2	40.3	25.4	22.9	16.2	12.9	10.4	9.4	5.81	3.23	2.68		
10.8V	136	123	102	82.5	74.5	58.5	42.5	39.4	24.7	21.9	15.8	12.8	10.2	9.3	5.75	3.21	2.66		

Charging Method

Trickle use Control voltage: 13.6 - 13.8V; Initial current: 9.75A or smaller

Cut off voltage

Discharge current	3.25A - 13A	13A - 32.5A	32.5A - 65A	65A - 130A	130A - 195A
Cut off voltage (V)	10.5	10.2	9.9	9.3	8.7

Influence of Temperature on Trickle life

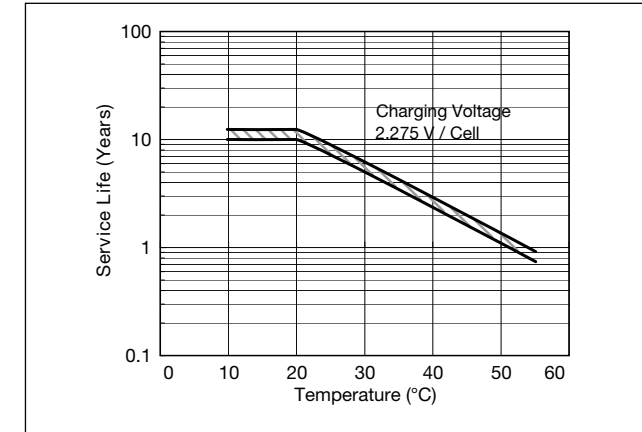

Residual capacity vs storage period

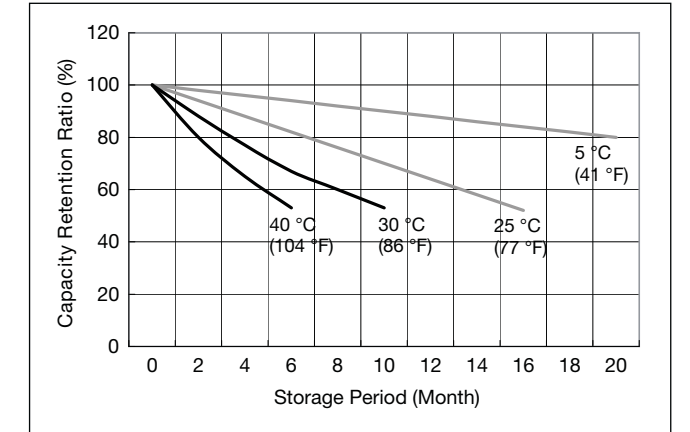

Constant-voltage and constant-current charge characteristics for Trickle use

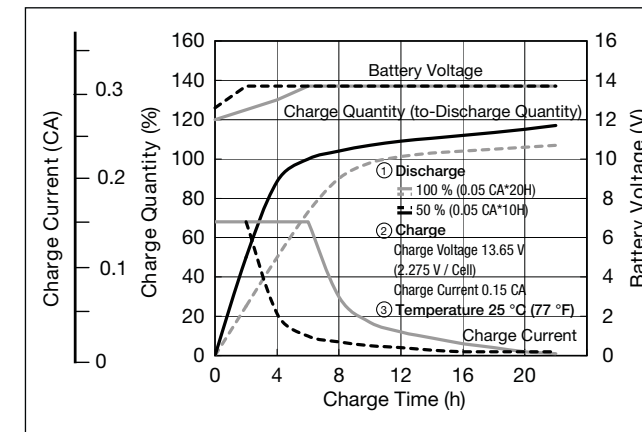

Discharge capacity by temperature and by discharge current

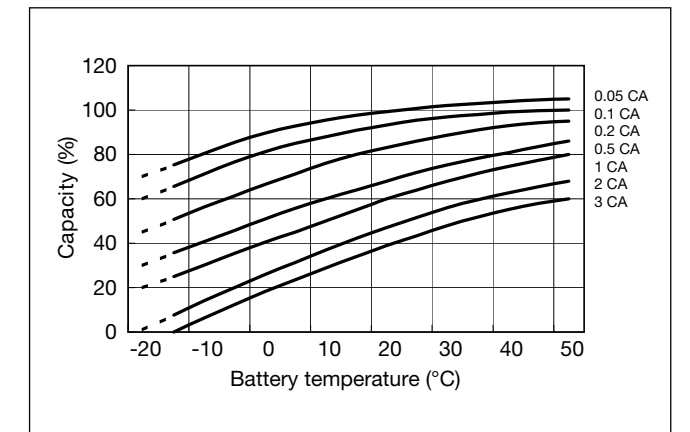

Discharge characteristics

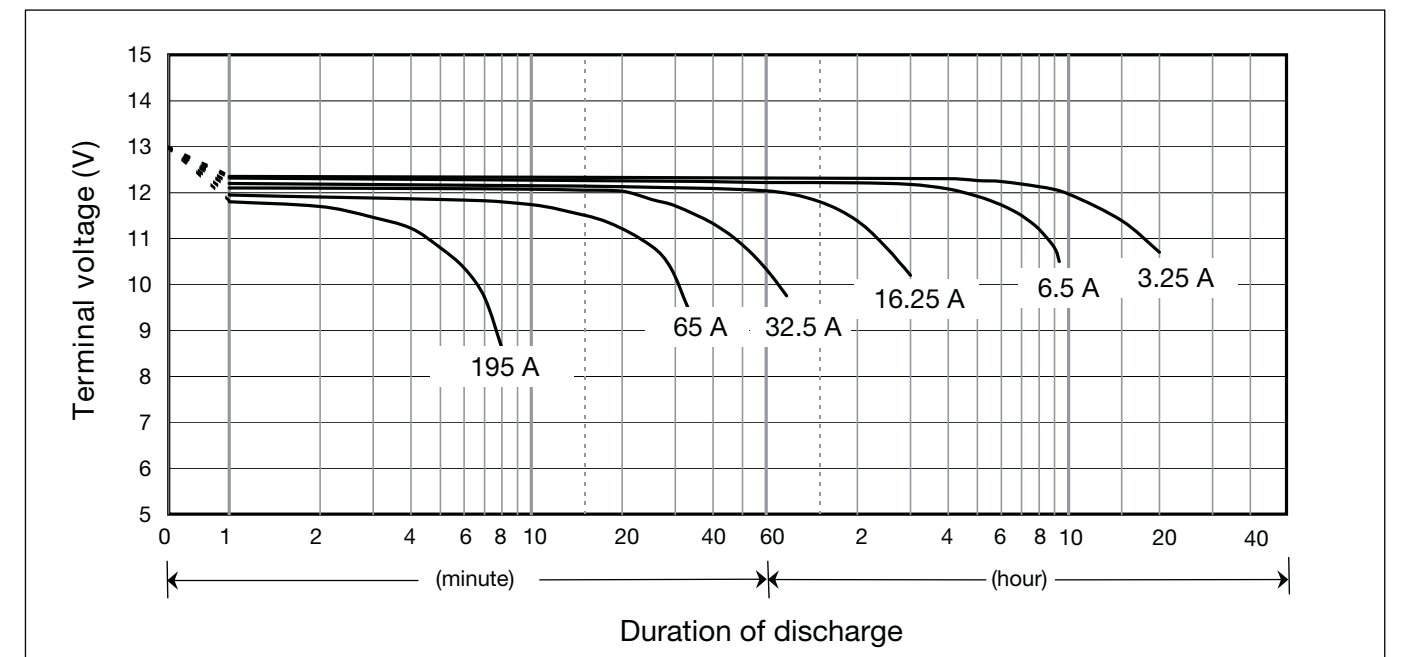

LC-X1275P*1

For standby power supplies.
Expected trickle design life: 10 – 12 years at 20°C according to Eurobat.

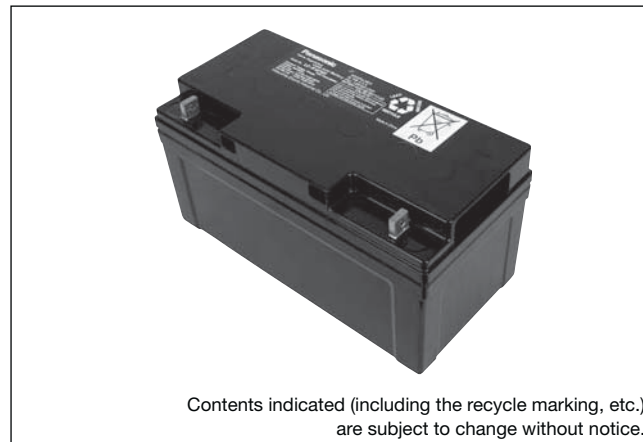

Dimensions (mm)

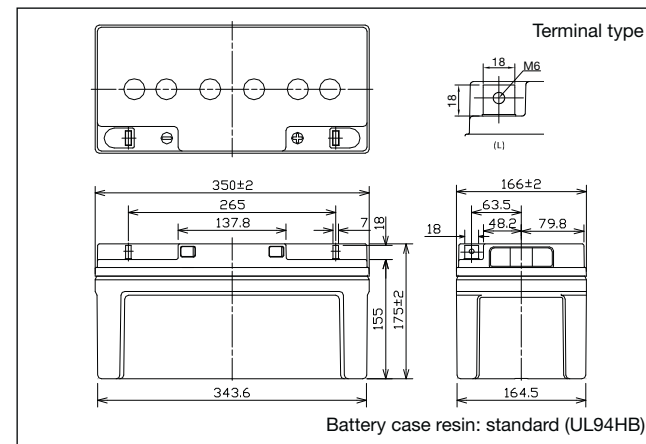

Specifications

Nominal voltage	12V	
Nominal capacity (20 hour rate)	75Ah	
Dimensions	Length	350mm
	Width	166mm
	Height	175mm
	Total Height	175mm
Approx. mass	24kg	
Terminal	M6 Bolt and Nut type	

Duration of discharge vs Discharge current

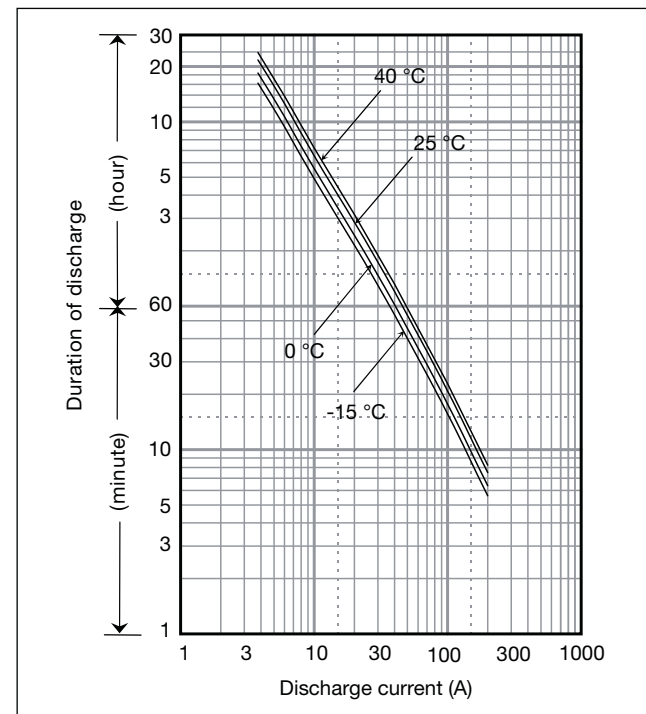

Characteristics

Capacity (25°C)	20 hour rate	75Ah
	10 hour rate	68Ah
	5 hour rate 1 hour rate	61Ah 45Ah
Internal resistance	Fully charged battery (25°C)	5mΩ
Temperature dependency of capacity (20 hour rate)	40°C	102%
	25°C	100%
	0°C	85%
	-15°C	65%
Self discharge (25°C)	After 3 months	91%
	After 6 months	82%
	After 12 months	64%

Watt Table

(Wattage/Battery)

Cut-off V	10min	15min	20min	30min	45min	1h	1.5h	2h	3h	4h	5h	6h	10h	20h	24h
9.6V	1985	1546	1350	1017	722	601	411	327	220	171	149	125	79.5	45.0	37.2
9.9V	1962	1538	1342	1009	703	599	403	325	216	169	147	125	79.5	45.0	37.2
10.2V	1955	1531	1327	994	699	595	400	321	215	168	144	124	78.6	45.0	37.2
10.5V	1783	1446	1265	978	691	591	395	317	215	168	144	124	78.6	45.0	37.2
10.8V	1693	1400	1234	962	597	512	355	301	205	164	143	120	77.8	44.1	37.2

Ampere Table

(Ampere/Battery)

Cut-off V	10min	15min	20min	30min	45min	1h	1.5h	2h	3h	4h	5h	6h	10h	20h	24h
9.6V	177	134	116	86.9	61.5	51.0	34.8	27.6	18.5	14.3	12.4	10.4	6.62	3.75	3.10
9.9V	175	134	116	86.3	59.9	50.8	34.1	27.4	18.2	14.2	12.2	10.4	6.62	3.75	3.10
10.2V	175	133	114	84.9	59.5	50.5	33.8	27.1	18.1	14.0	12.0	10.4	6.55	3.75	3.10
10.5V	159	126	109	83.6	58.9	50.2	33.4	26.8	18.1	14.0	12.0	10.4	6.55	3.75	3.10
10.8V	151	122	106	82.3	50.8	43.5	30.1	25.4	17.3	13.7	11.9	10.0	6.49	3.68	3.10

*1 This battery is also available with a flame retardant battery case resin (UL94 V-0).

Charging Method

Trickle use	Control voltage: 13.6 - 13.8V; Initial current: 11.25A or smaller
-------------	--

Cut off voltage

Discharge current	3.75A - 15A	15A - 37.5A	37.5A - 75A	75A - 150A	150A - 225A
Cut off voltage (V)	10.5	10.2	9.9	9.3	8.7

Influence of Temperature on Trickle life

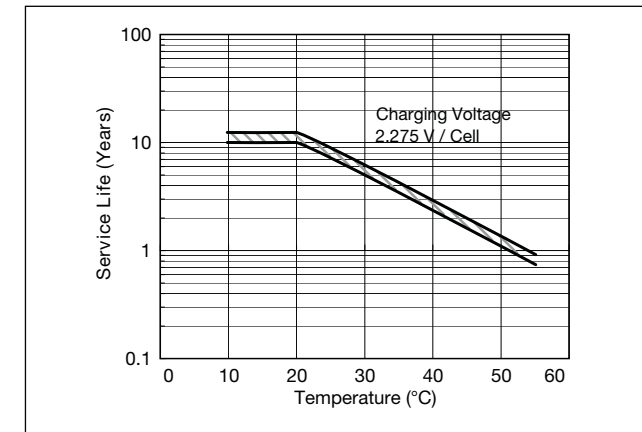

Residual capacity vs storage period

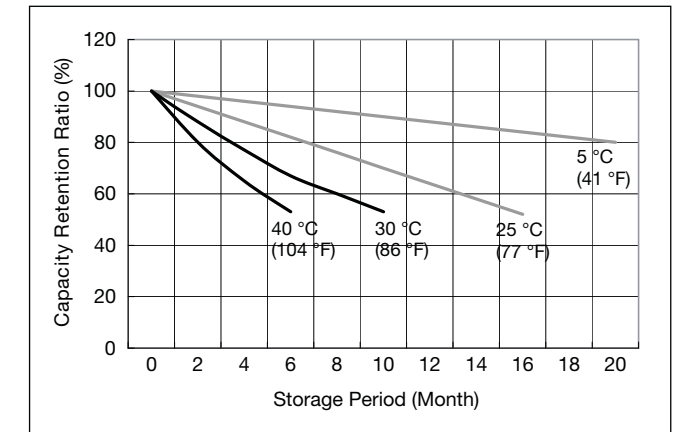

Constant-voltage and constant-current charge characteristics for Trickle use

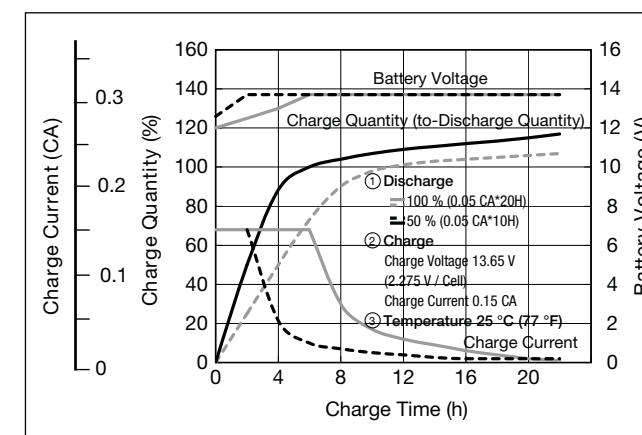

Discharge capacity by temperature and by discharge current

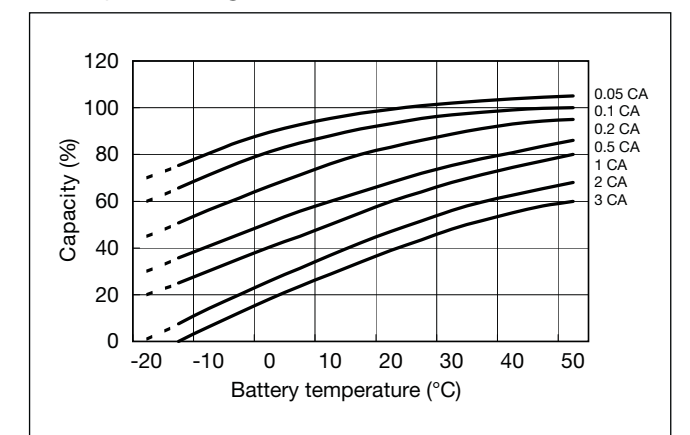

Discharge characteristics

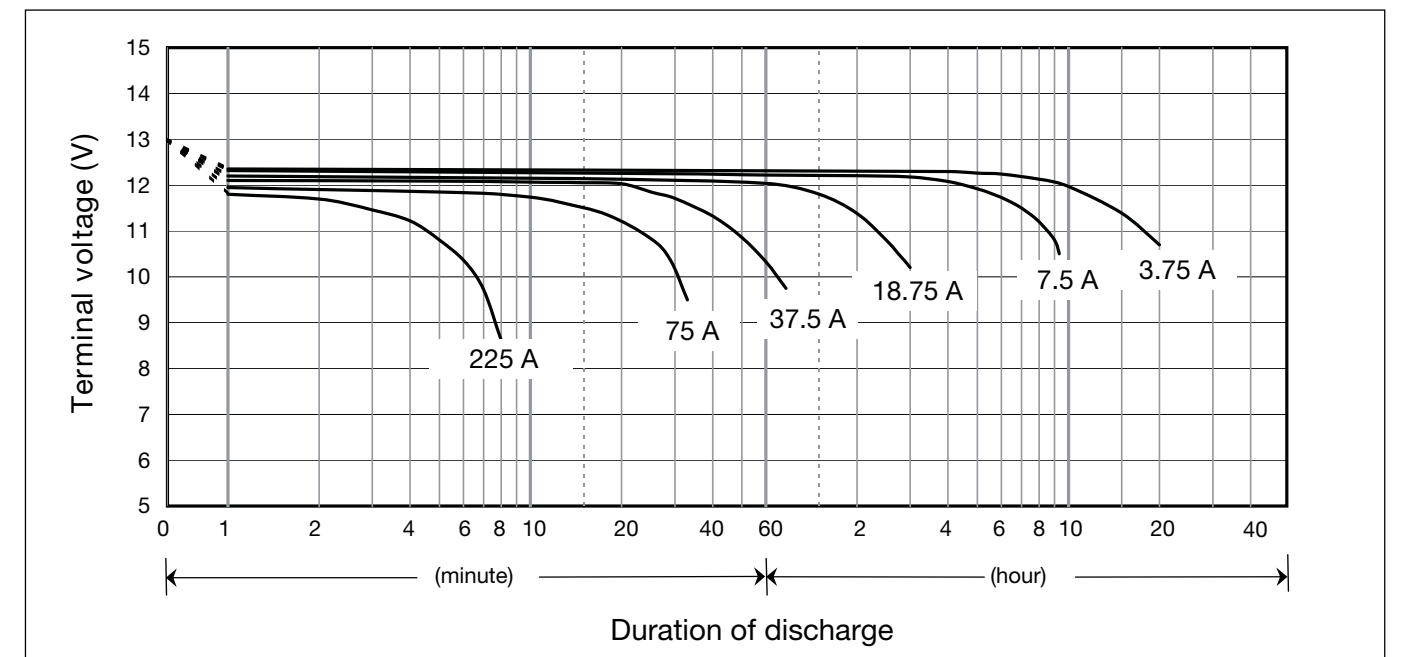

LC-XB12100P*1

For standby power supplies.
Expected trickle design life: 10 – 12 years at 20°C according to Eurobat.



Dimensions (mm)

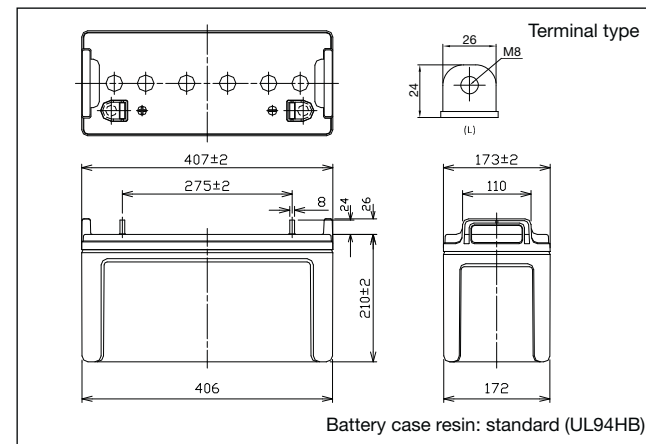

Specifications

Nominal voltage	12V	
Nominal capacity (20 hour rate)	100Ah	
Dimensions	Length	407mm
	Width	173mm
	Height	210mm
	Total Height	236mm
Approx. mass	36.5kg	
Terminal	M8 Bolt and Nut type	

Duration of discharge vs Discharge current

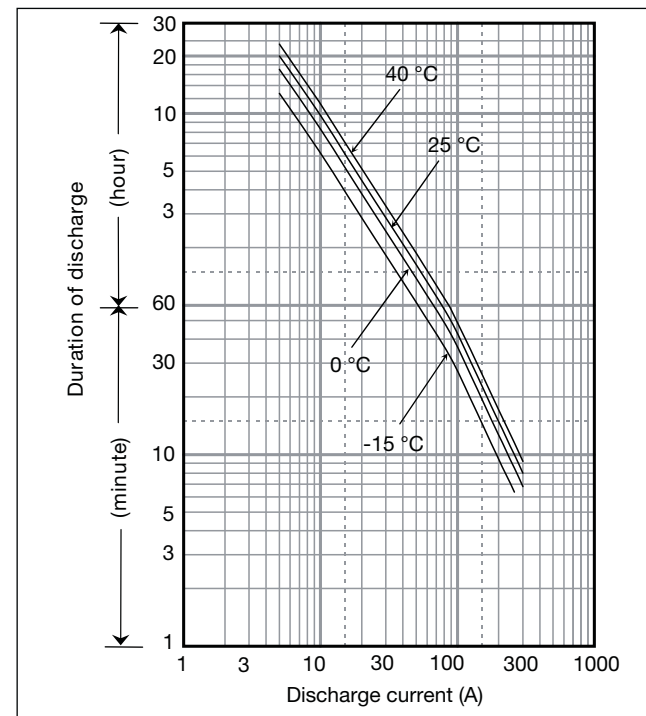

Characteristics

Capacity (25°C)	20 hour rate 10 hour rate 5 hour rate 1 hour rate	100Ah 98Ah 90Ah 70Ah
Internal resistance	Fully charged battery (25°C)	4.5mΩ
Temperature dependency of capacity (20 hour rate)	40°C 25°C 0°C -15°C	102% 100% 85% 65%
Self discharge (25°C)	After 3 months After 6 months After 12 months	91% 82% 64%

Watt Table

(Wattage/Battery)

Cut-off V	10min	15min	20min	30min	45min	1h	1.5h	2h	3h	4h	5h	6h	10h	20h	24h
9.6V	2306	1834	1592	1206	892	733	582	430	281	226	170	154	88.3	47.0	38.5
9.9V	2254	1790	1554	1177	869	714	567	419	276	221	165	149	85.3	47.0	38.5
10.2V	2204	1726	1498	1139	877	694	551	413	272	216	160	145	84.3	46.5	38.0
10.5V	2134	1705	1487	1130	852	675	536	405	267	213	160	145	83.3	46.5	38.0
10.8V	1947	1624	1479	1094	840	666	528	395	262	208	155	150	82.3	45.5	37.2

Ampere Table

(Ampere/Battery)

Cut-off V	10min	15min	20min	30min	45min	1h	1.5h	2h	3h	4h	5h	6h	10h	20h	24h
9.6V	265	201	174	130	92.0	76.3	52.0	41.3	27.7	21.4	18.6	15.6	9.9	5.0	4.2
9.9V	262	200	173	129	89.5	76.0	51.0	41.0	27.2	21.2	18.3	15.6	9.9	5.0	4.2
10.2V	261	199	171	127	89.0	75.5	50.6	40.5	27.0	21.0	18.0	15.5	9.8	5.0	4.2
10.5V	238	188	163	125	88.0	75.0	50.0	40.0	27.0	21.0	18.0	15.5	9.8	5.0	4.2
10.8V	226	182	159	123	76.0	65.0	45.0	38.0	25.8	20.5	17.8	15.0	9.7	4.9	4.2

*1 This battery is also available with a flame retardant battery case resin (UL94 V-0).

Charging Method

Trickle use Control voltage: 13.6 - 13.8V; Initial current 15A or smaller

Cut off voltage

Discharge current	5A - 20A	20A - 50A	50A - 100A	100A - 200A	200A - 300A
Cut off voltage (V)	10.5	10.2	9.9	9.3	8.7

Influence of Temperature on Trickle life

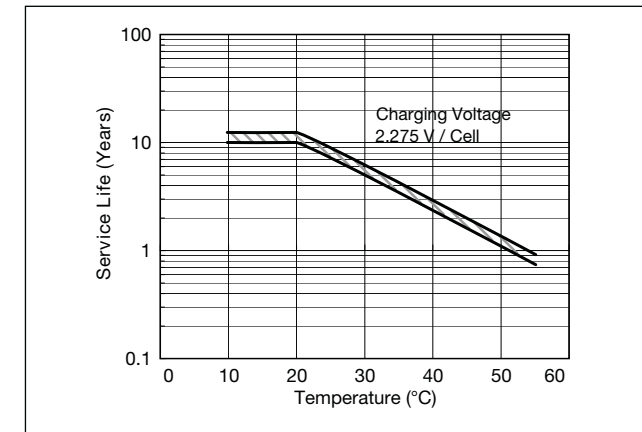

Residual capacity vs storage period

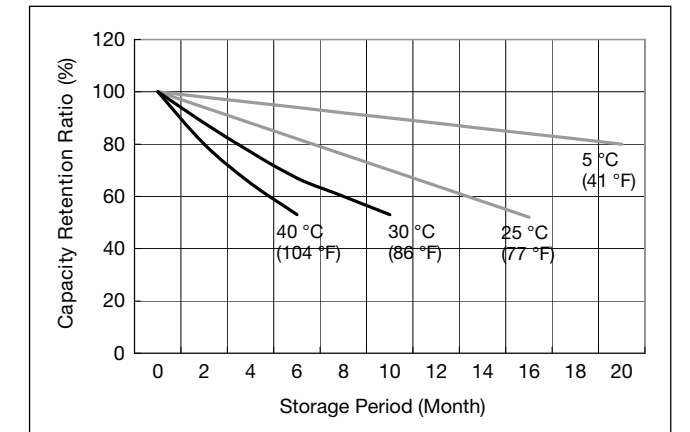

Constant-voltage and constant-current charge characteristics for Trickle use

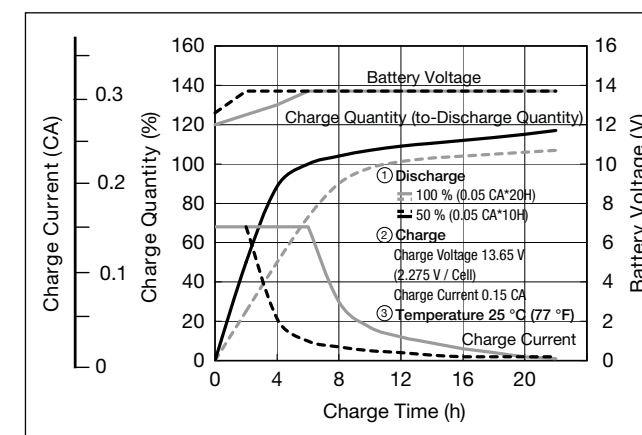

Discharge capacity by temperature and by discharge current

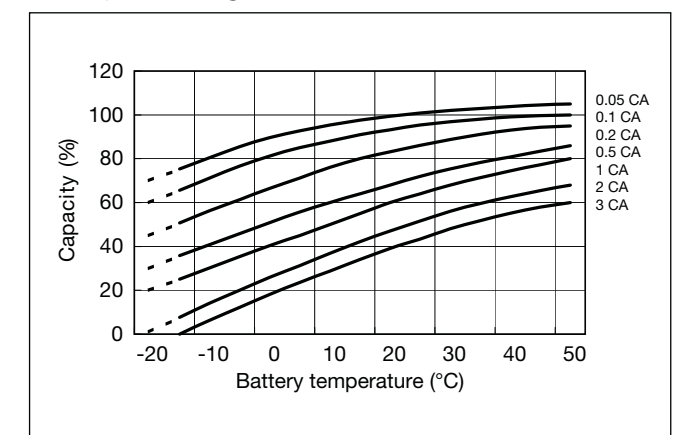

Discharge characteristics

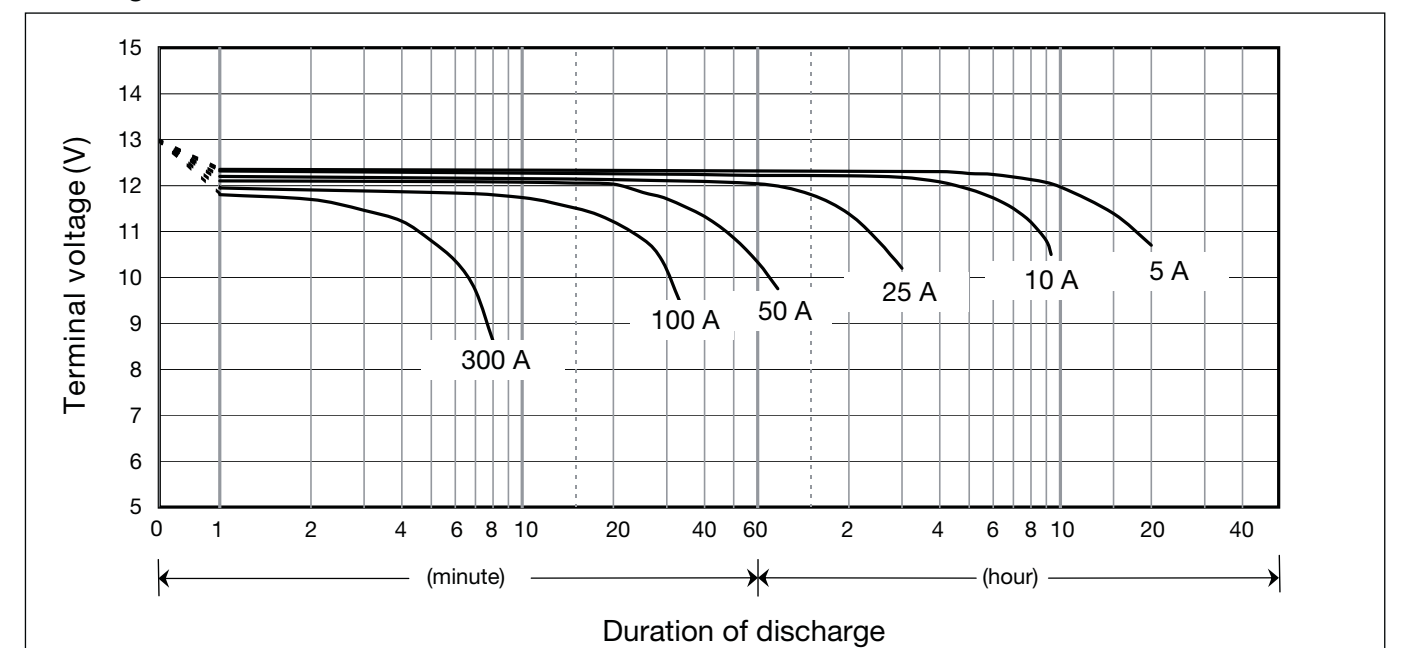

LC-X12120P*1



For standby power supplies.
Expected trickle design life: 10 – 12 years at 20°C according to Eurobat.

Dimensions (mm)

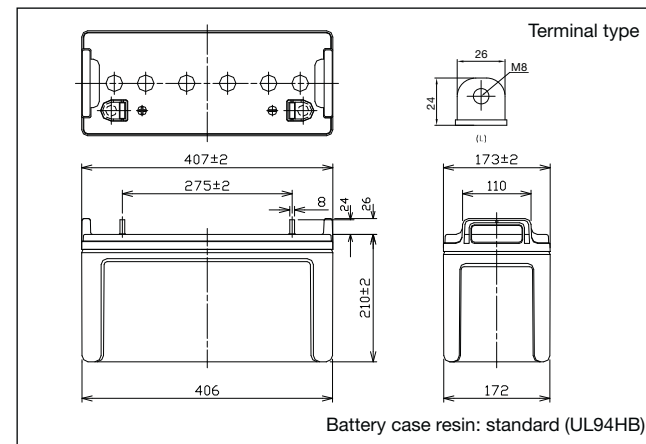

Specifications

Nominal voltage	12V	
Nominal capacity (20 hour rate)	120Ah	
Dimensions	Length	407mm
	Width	173mm
	Height	210mm
	Total Height	236mm
Approx. mass	35.5kg	
Terminal	M8 Bolt and Nut type	

Duration of discharge vs Discharge current

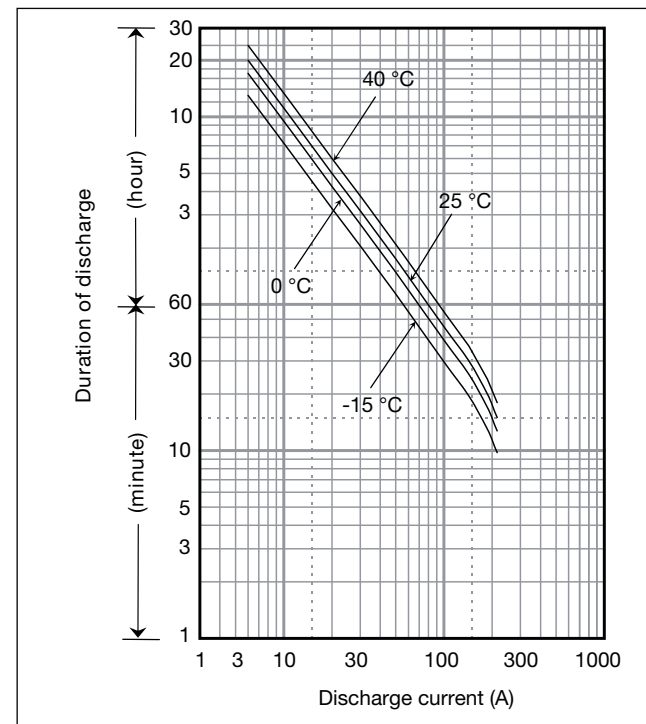

Characteristics

Capacity (25°C)	20 hour rate	120Ah
	10 hour rate	109Ah
	5 hour rate	99Ah
	1 hour rate	74Ah
Internal resistance	Fully charged battery (25°C)	3.5mΩ
Temperature dependency of capacity (20 hour rate)	40°C	102%
	25°C	100%
	0°C	85%
	-15°C	65%
Self discharge (25°C)	After 3 months	91%
	After 6 months	82%
	After 12 months	64%

Watt Table

Cut-off V	(Wattage/Battery)													
	15min	20min	30min	45min	1h	1.5h	2h	3h	4h	5h	6h	10h	20h	24h
9.6V	1920	1677	1409	1095	835	663	499	326	261	197	179	104	60.2	46.8
9.9V	1910	1667	1370	1062	820	662	486	322	255	191	177	103	60.1	46.8
10.2V	1901	1648	1322	1040	805	642	479	315	249	185	168	101	60.0	46.7
10.5V	1796	1571	1316	1025	764	629	470	310	246	184	166	101	60.0	46.6
10.8V	1739	1532	1281	980	672	559	458	306	240	180	163	100	59.9	46.6

Ampere Table

Cut-off V	(Ampere/Battery)													
	15min	20min	30min	45min	1h	1.5h	2h	3h	4h	5h	6h	10h	20h	24h
9.6V	229	198	149	105	86.9	59.3	47.9	32.1	23.7	20.6	17.4	11.1	6.00	5.04
9.9V	228	197	148	102	86.6	58.1	47.5	31.5	23.4	20.4	17.4	11.1	6.00	5.04
10.2V	227	195	146	102	85.9	57.7	46.9	31.2	23.2	20.0	17.3	11.0	6.00	5.04
10.5V	215	186	143	101	85.4	56.9	46.3	31.3	23.2	20.0	17.3	11.0	6.00	5.04
10.8V	208	181	141	87	74.0	51.2	44.0	29.9	22.7	19.8	16.7	10.9	5.88	5.00

*1 This battery is also available with a flame retardant battery case resin (UL94 V-0).

Charging Method

Trickle use	Control voltage: 13.6 - 13.8V; Initial current 18A or smaller
-------------	---

Cut off voltage

Discharge current	6A - 24A	24A - 60A	60A - 120A	120A - 240A
Cut off voltage (V)	10.5	10.2	9.9	9.3

Influence of Temperature on Trickle life

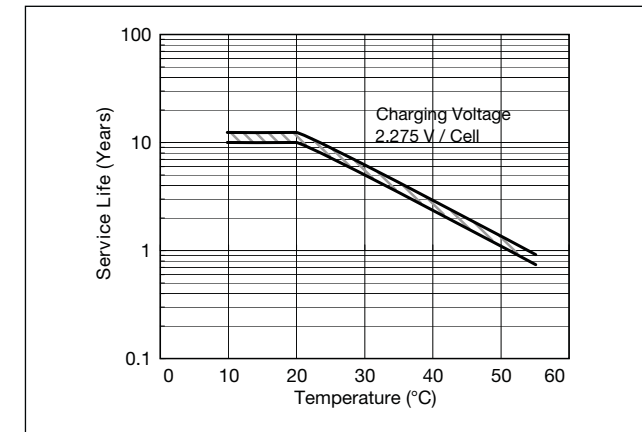

Residual capacity vs storage period

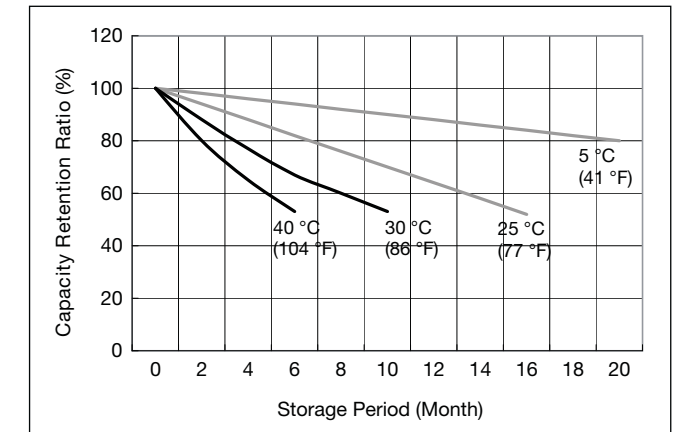

Constant-voltage and constant-current charge characteristics for Trickle use

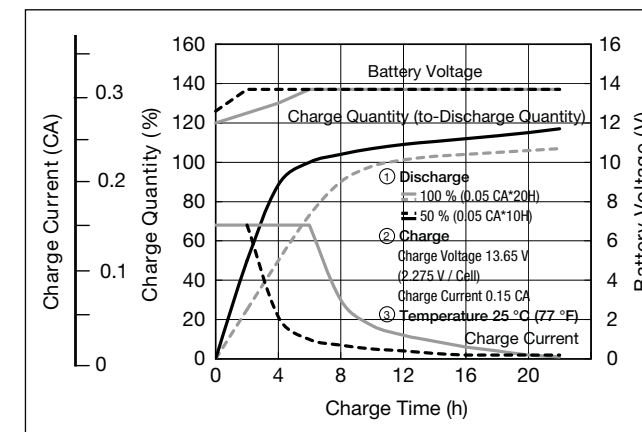

Discharge capacity by temperature and by discharge current

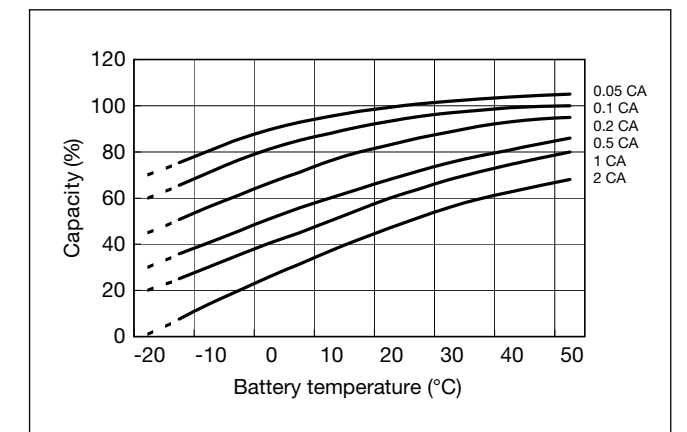

Discharge characteristics

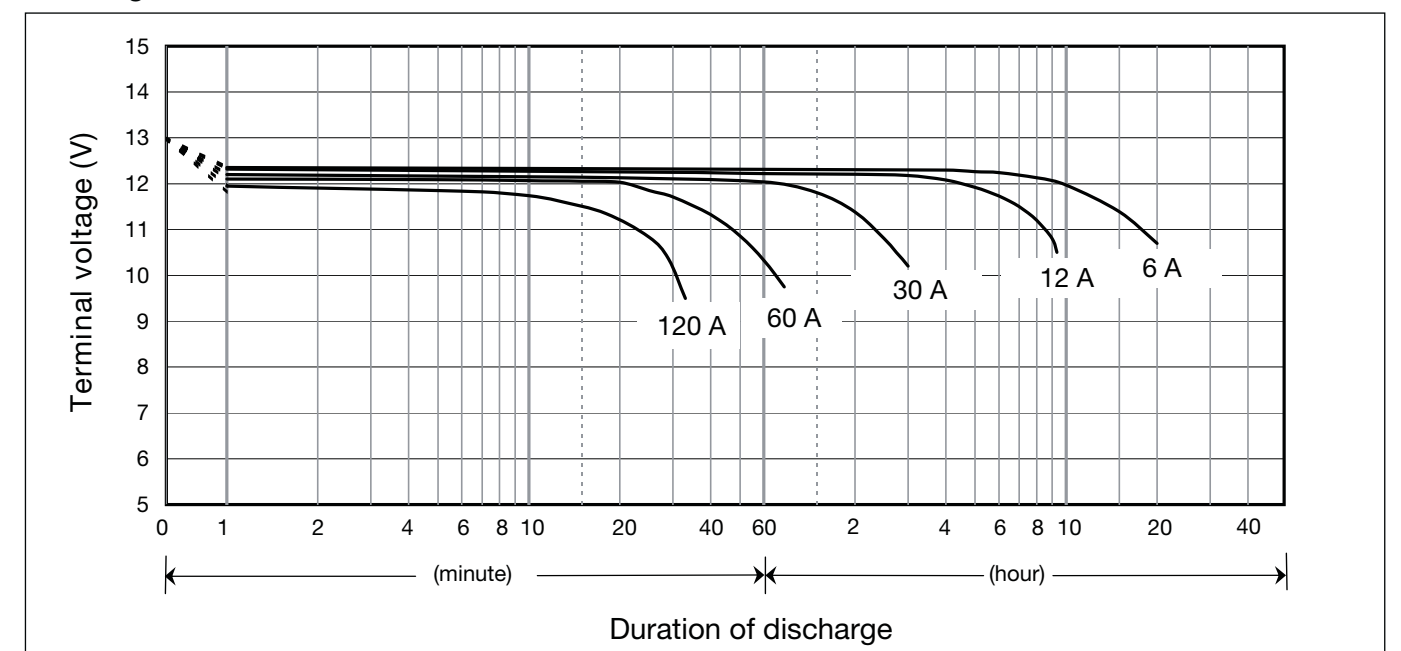

LC-CA1212P

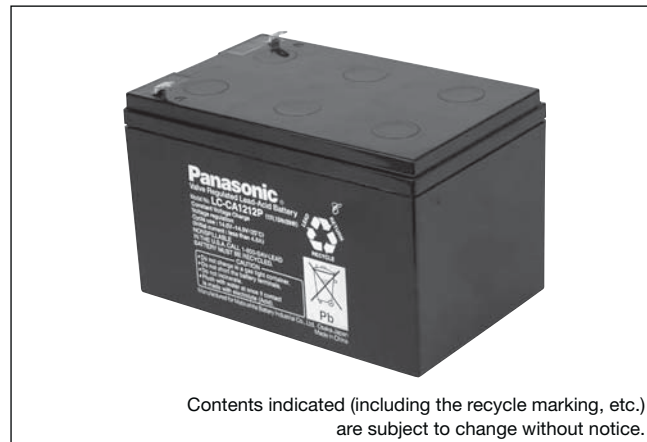

For main power supplies.
Cycle long life type.

Dimensions (mm)

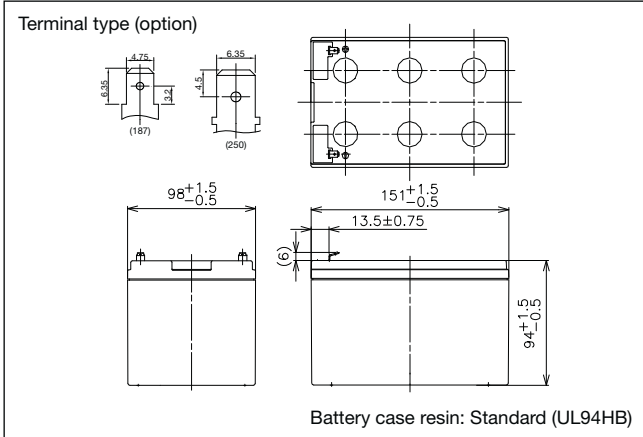

Specifications

Nominal voltage	12V	
Nominal capacity (20 hour rate)	12Ah	
Dimensions	Length	151mm
	Width	98mm
	Height	94mm
	Total Height	100mm
Approx. mass	3.8kg	
Terminal	Faston 187 or Faston 250 with hole	

Characteristics

Capacity (25°C)	20 hour rate	12.0Ah
	10 hour rate	11.3Ah
	5 hour rate	10.4Ah
	1 hour rate	8.1Ah
Internal resistance	Fully charged battery (25°C)	30mΩ
Temperature dependency of capacity (20 hour rate)	40°C	102%
	25°C	100%
	0°C	85%
	-15°C	65%
Self discharge (25°C)	After 3 months	91%
	After 6 months	82%
	After 12 months	64%

Duration of discharge vs Discharge current

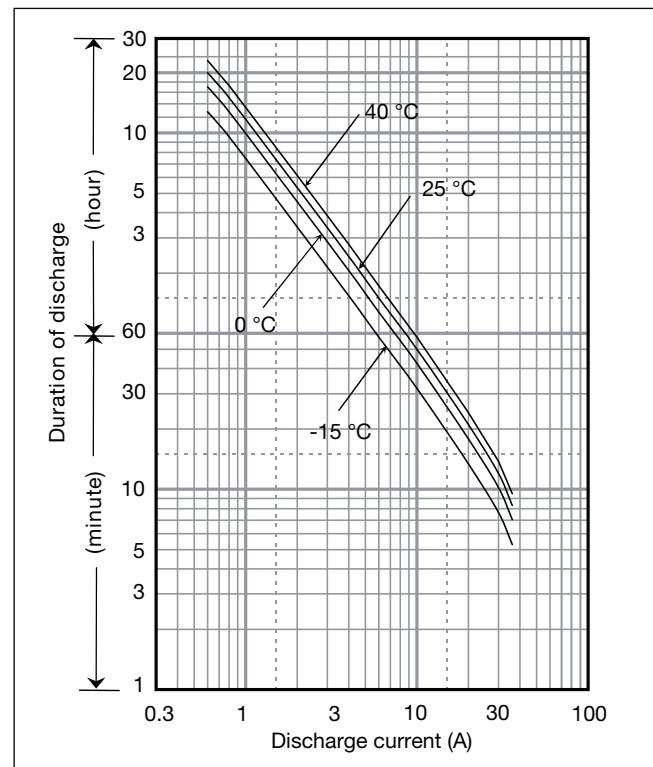

Watt Table

Cut-off V	(Wattage/Battery)																	
	3min	5min	10min	15min	20min	30min	45min	1h	1.5h	2h	3h	4h	5h	6h	10h	20h	24h	
9.6V	679	559	384	298	247	183	137	105	70.3	54.5	38.1	28.8	24.1	21.7	13.3	7.22	6.02	
9.9V	649	537	373	288	241	177	135	104	69.9	54.2	37.8	28.8	24.1	21.7	13.3	7.22	6.02	
10.2V	607	506	363	282	235	177	134	102	69.1	53.9	37.5	28.8	24.0	21.6	13.2	7.21	6.01	
10.5V	556	475	343	271	231	172	133	100	68.5	53.3	36.9	28.7	24.0	21.6	13.2	7.20	6.00	
10.8V	495	434	321	261	225	166	123	98	66.1	52.1	36.3	28.4	23.8	21.5	13.1	7.18	5.98	

Ampere Table

Cut-off V	(Ampere/Battery)																	
	3min	5min	10min	15min	20min	30min	45min	1h	1.5h	2h	3h	4h	5h	6h	10h	20h	24h	
9.6V	61.1	50.1	34.3	25.9	21.3	15.6	11.7	8.90	5.95	4.60	3.20	2.41	2.01	1.81	1.11	0.602	0.502	
9.9V	58.4	48.2	33.3	25.0	20.8	15.1	11.5	8.80	5.92	4.58	3.18	2.41	2.01	1.81	1.11	0.602	0.502	
10.2V	54.6	45.4	32.4	24.5	20.3	15.1	11.4	8.70	5.85	4.55	3.15	2.41	2.00	1.80	1.10	0.601	0.501	
10.5V	50.0	42.6	30.6	23.6	19.9	14.7	11.3	8.50	5.80	4.50	3.10	2.40	2.00	1.80	1.10	0.600	0.500	
10.8V	44.5	38.9	28.7	22.7	19.4	14.2	10.5	8.30	5.60	4.40	3.05	2.38	1.99	1.79	1.09	0.598	0.498	

Charging Method

Cycle Use	Control voltage 14.5 - 14.9V; Initial current 4.8A or smaller
-----------	---

Residual capacity vs storage period

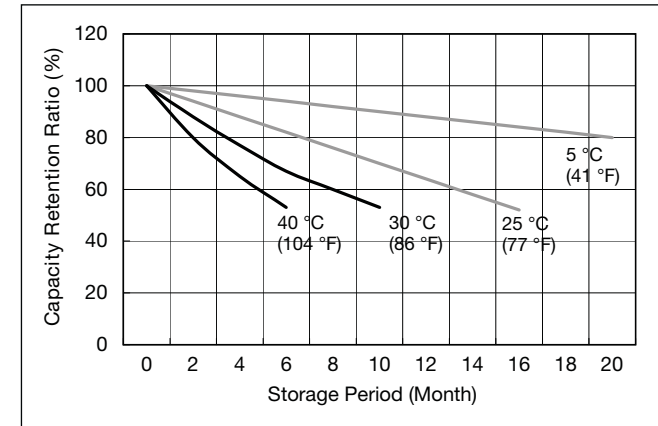

Cut off voltage

Discharge current	0.6A - 2.4A	2.4A - 6A	6A - 12A	12A - 24A	24A - 36A
Cut off voltage (V)	10.5	10.2	9.9	9.3	8.7

Cycle life vs Depth of discharge

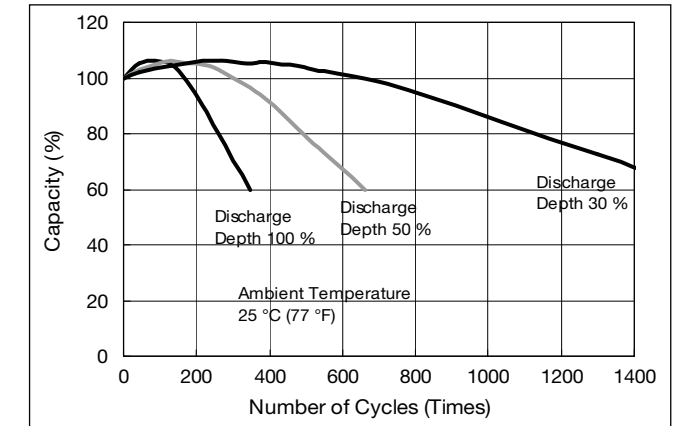

Constant-voltage and constant-current charge characteristics

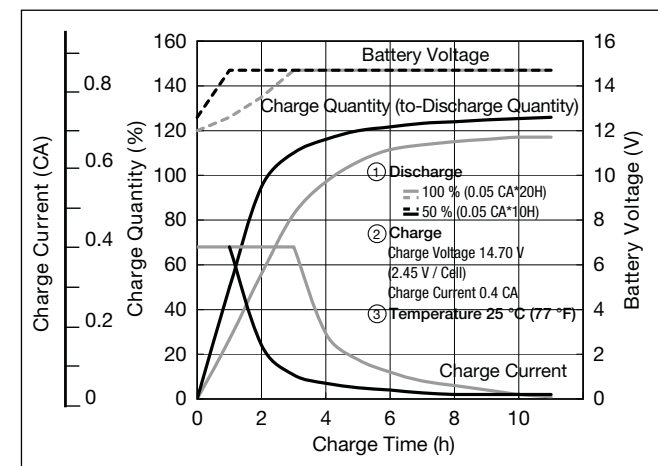

Discharge capacity by temperature and by discharge current

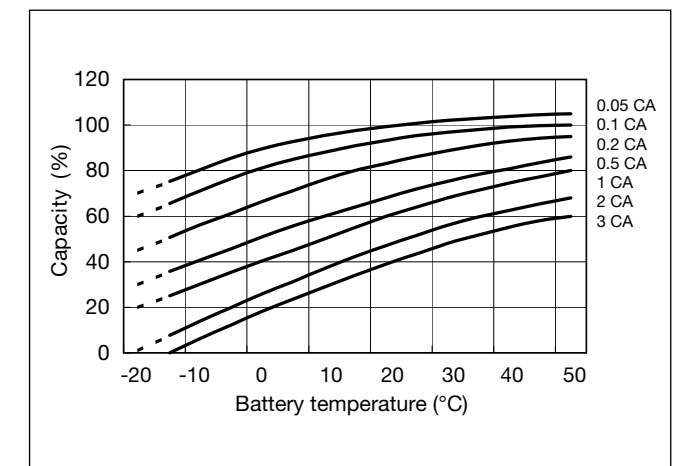

Discharge characteristics

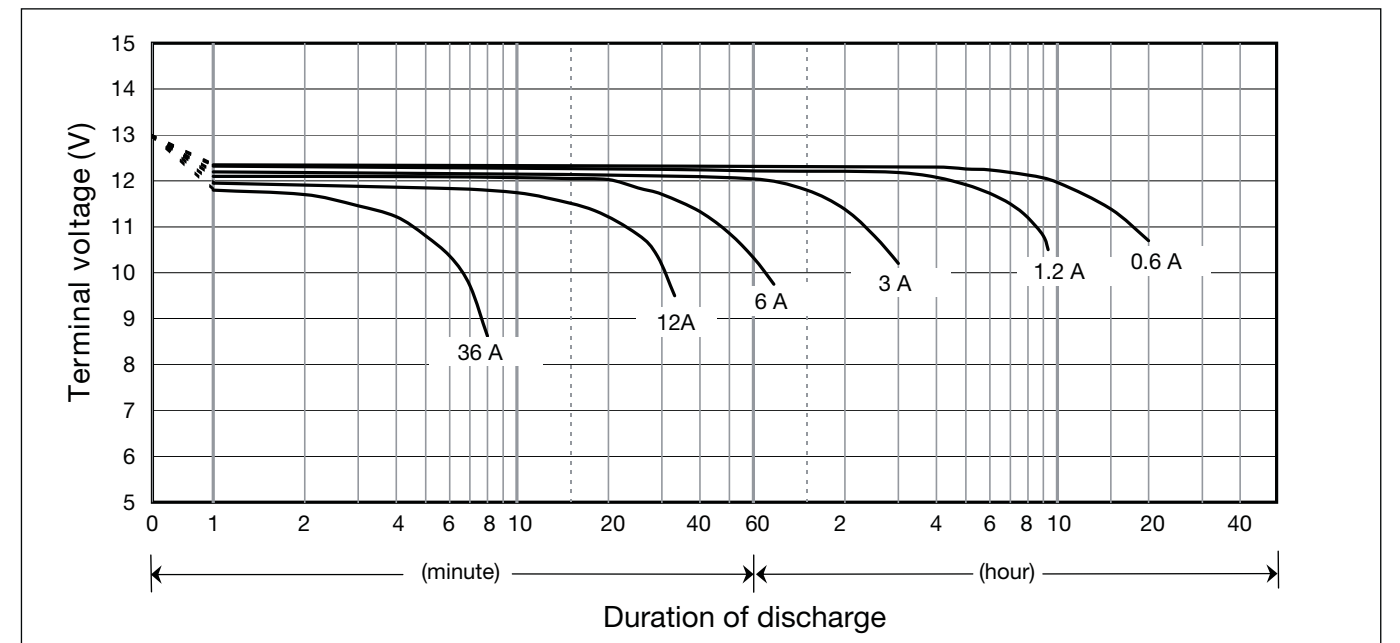

LC-CA1215P



For main power supplies.
Cycle long life type.

Dimensions (mm)

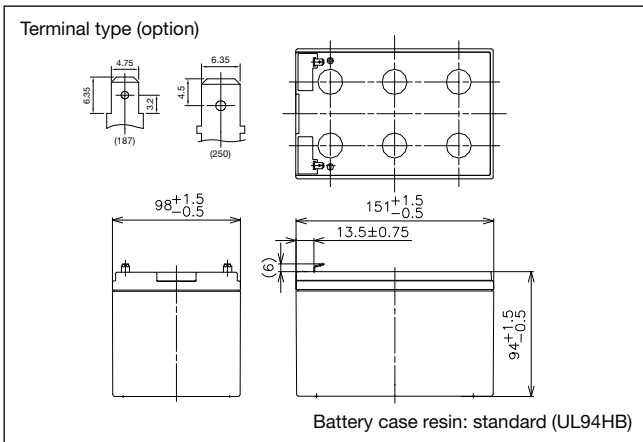

Specifications

Nominal voltage	12V	
Nominal capacity (20 hour rate)	15Ah	
Dimensions	Length	151mm
	Width	98mm
	Height	94mm
	Total Height	100mm
Approx. mass	4.2kg	
Terminal	Faston 187 or Faston 250 with hole	

Duration of discharge vs Discharge current

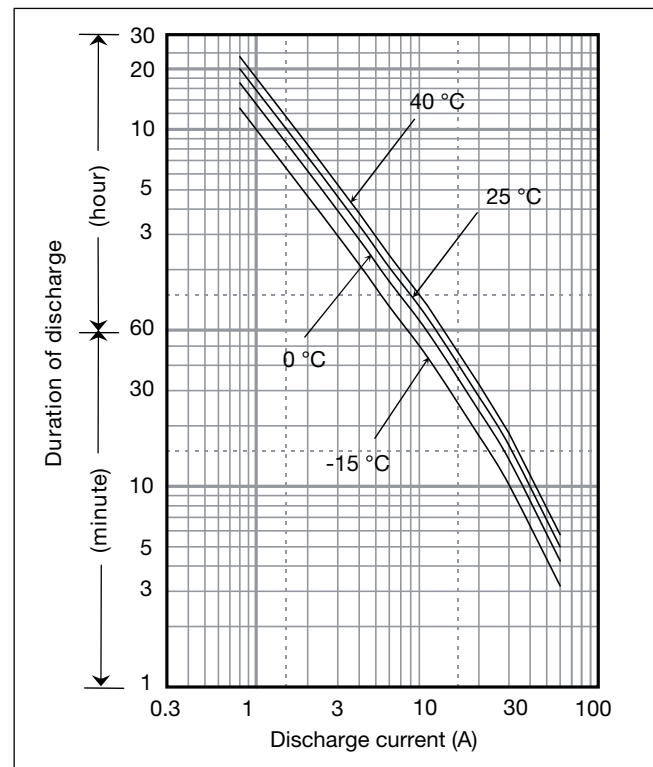

Characteristics

Capacity (25°C)	20 hour rate	15.0Ah
	10 hour rate	14.0Ah
	5 hour rate	12.9Ah
	1 hour rate	10.0Ah
Internal resistance	Fully charged battery (25°C)	30mΩ
Temperature dependency of capacity (20 hour rate)	40°C	102%
	25°C	100%
	0°C	85%
	-15°C	65%
Self discharge (25°C)	After 3 months	91%
	After 6 months	82%
	After 12 months	64%

Watt Table

Cut-off V	(Wattage/Battery)																	
	3min	5min	10min	15min	20min	30min	45min	1h	1.5h	2h	3h	4h	5h	6h	10h	20h	24h	
9.6V	850	682	455	350	292	217	157	123	83.9	65.0	47.1	36.0	29.9	25.2	16.2	8.75	7.30	
9.9V	799	646	444	343	286	213	156	123	82.8	64.6	46.9	35.8	29.7	25.1	16.1	8.74	7.29	
10.2V	741	607	433	336	281	211	154	121	81.4	63.4	46.4	35.7	29.5	24.9	15.9	8.72	7.27	
10.5V	667	555	404	318	270	206	152	118	80.1	61.9	45.7	35.5	29.4	24.8	15.9	8.70	7.25	
10.8V	576	497	368	300	263	199	146	116	77.7	59.6	44.8	35.1	28.9	24.5	15.7	8.66	7.21	

Ampere Table

Cut-off V	(Ampere/Battery)																	
	3min	5min	10min	15min	20min	30min	45min	1h	1.5h	2h	3h	4h	5h	6h	10h	20h	24h	
9.6V	76.5	61.2	40.6	30.4	25.2	18.5	13.4	10.5	7.11	5.49	3.96	3.01	2.49	2.10	1.35	0.73	0.61	
9.9V	71.8	58.0	39.7	29.9	24.7	18.2	13.3	10.4	7.01	5.45	3.94	3.00	2.48	2.09	1.34	0.73	0.61	
10.2V	66.6	54.5	38.6	29.2	24.2	18.1	13.1	10.3	6.89	5.36	3.90	2.99	2.46	2.08	1.33	0.73	0.61	
10.5V	59.9	49.8	36.1	27.6	23.3	17.6	13.0	10.0	6.78	5.22	3.84	2.97	2.45	2.07	1.33	0.72	0.60	
10.8V	51.8	44.6	32.9	26.1	22.7	17.0	12.5	9.82	6.58	5.03	3.77	2.94	2.41	2.04	1.31	0.72	0.60	

Charging Method

Cycle Use	Control voltage 14.5 - 14.9V; Initial current 6A or smaller
-----------	---

Cut off voltage

Discharge current	0.75A - 3A	3A - 7.5A	7.5A - 15A	15A - 30A	30A - 45A
Cut off voltage (V)	10.5	10.2	9.9	9.3	8.7

Residual capacity vs storage period

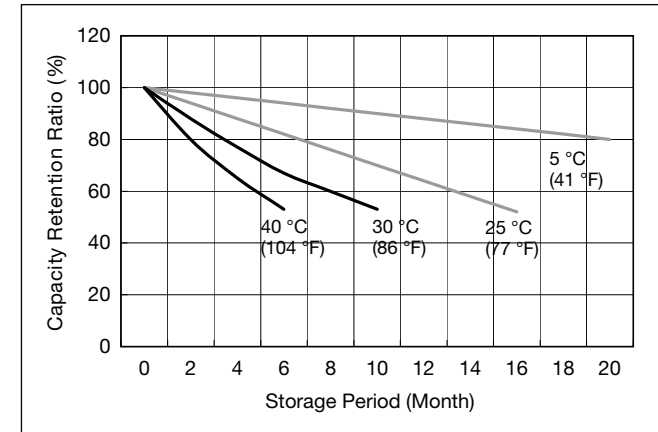

Cycle life vs Depth of discharge

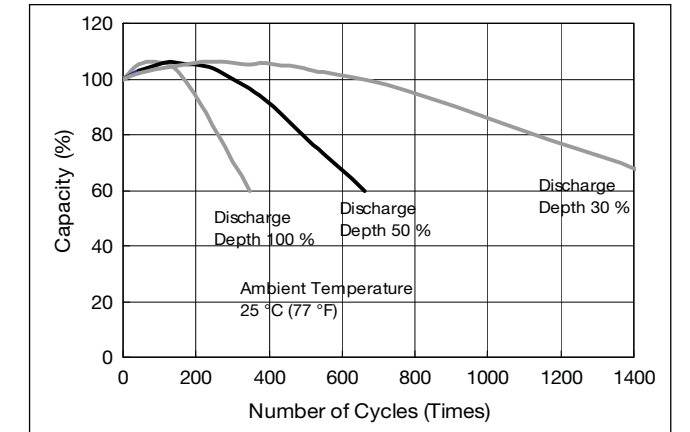

Constant-voltage and constant-current charge characteristics

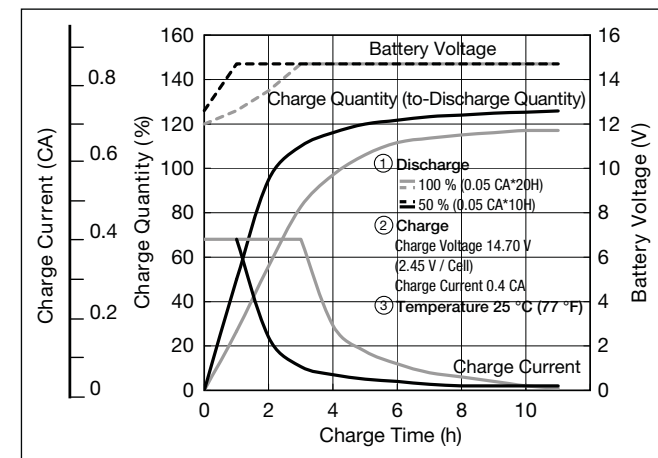

Discharge capacity by temperature and by discharge current

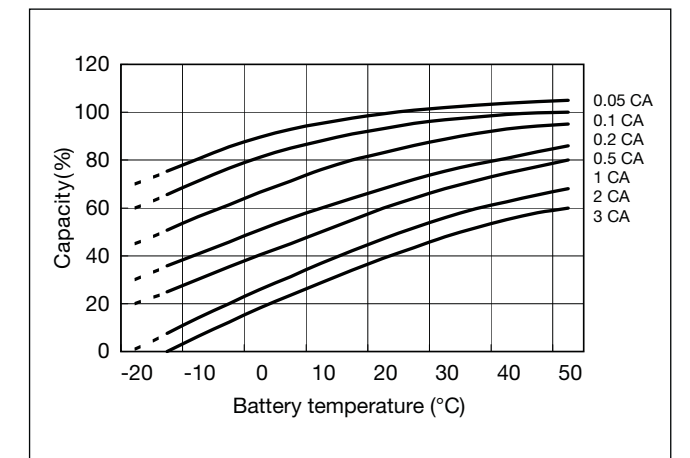

Discharge characteristics

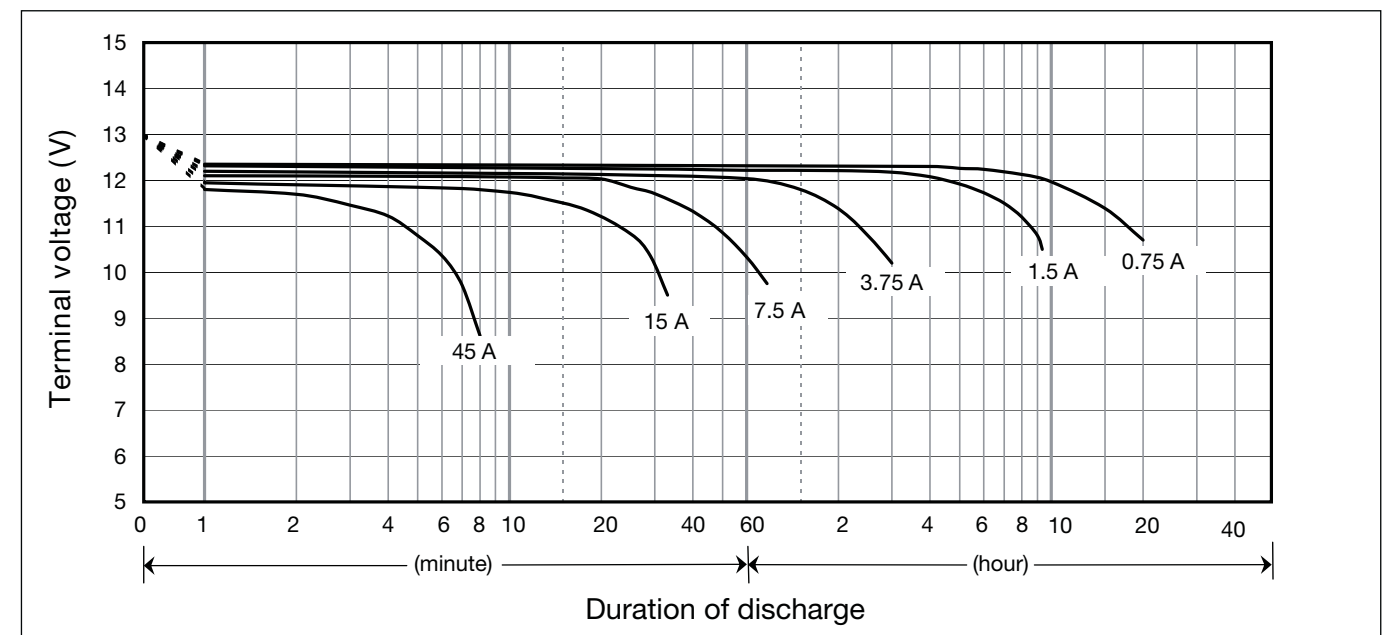

LC-CA1216

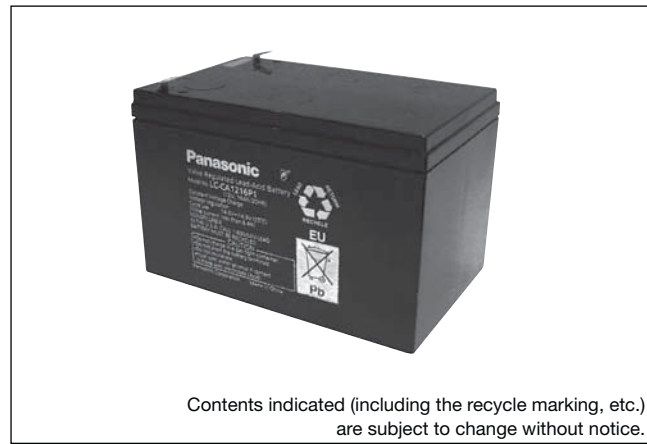

For main power supplies.
Cycle long life type.

Dimensions (mm)

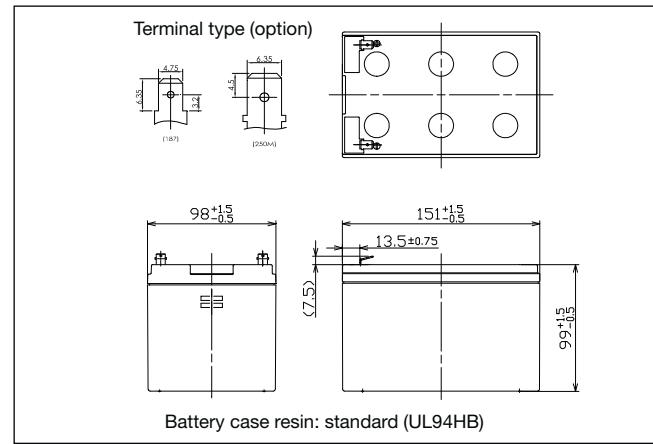

Specifications

Nominal voltage	12V	
Nominal capacity (20 hour rate)	16Ah	
Dimensions	Length	151mm
	Width	98mm
	Height	99mm
	Total Height	105mm
Approx. mass	4.70kg	
Terminal	Faston 187 & 250M	

Characteristics

Capacity (25°C)	20 hour rate	16Ah
	10 hour rate	14Ah
Internal resistance	5 hour rate	12Ah
	1 hour rate	11Ah
	Fully charged battery (25°C)	11mΩ
Temperature dependency of capacity (20 hour rate)	40°C	102%
	25°C	100%
	0°C	85%
	-15°C	65%
Self discharge (25°C)	After 3 months	91%
	After 6 months	82%
	After 12 months	64%

Duration of discharge vs Discharge current

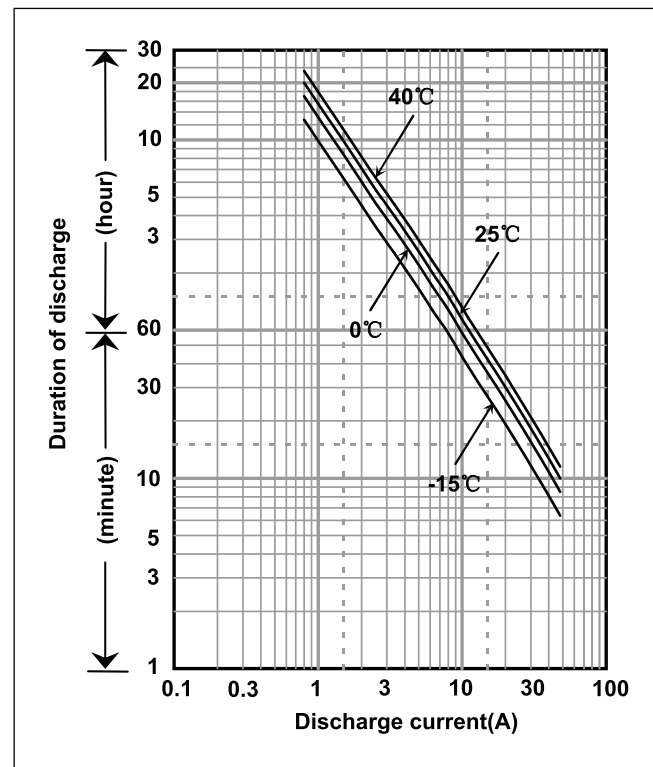

Watt Table

Cut-off V	(Wattage/Battery)															
	3min	5min	10min	15min	20min	30min	45min	1h	1.5h	2h	3h	4h	5h	6h	10h	20h
9.6V	879	721	517	381	308	225	165	132	94.2	74.7	53.1	40.5	33.0	28.1	17.8	9.54
9.9V	825	683	505	374	302	220	163	131	92.9	74.2	52.8	40.4	32.9	28.0	17.8	9.52
10.2V	766	642	491	366	296	219	162	129	91.3	72.9	52.3	40.2	32.7	27.8	17.6	9.50
10.5V	689	586	459	346	285	213	160	126	89.9	71.1	51.5	40.0	32.5	27.6	17.5	9.48
10.8V	595	526	418	327	277	206	153	123	87.2	68.5	50.6	39.5	32.0	27.3	17.4	9.43

Ampere Table

Cut-off V	(Ampere/Battery)															
	3min	5min	10min	15min	20min	30min	45min	1h	1.5h	2h	3h	4h	5h	6h	10h	20h
9.6V	83.3	68.7	48.0	35.0	28.1	20.5	14.9	11.6	8.07	6.70	4.64	3.47	2.84	2.35	1.51	0.800
9.9V	77.3	64.4	46.9	34.3	27.6	20.1	14.8	11.5	7.96	6.66	4.61	3.45	2.83	2.34	1.50	0.800
10.2V	71.4	60.4	45.6	33.6	27.0	19.9	14.6	11.3	7.83	6.54	4.57	3.44	2.81	2.33	1.49	0.800
10.5V	63.4	54.1	42.6	31.8	26.0	19.5	14.5	11.1	7.71	6.38	4.49	3.42	2.80	2.32	1.48	0.800
10.8V	53.6	47.8	38.8	30.0	25.3	18.8	13.9	10.8	7.47	6.15	4.41	3.38	2.75	2.29	1.47	0.800

Charging Method

Cycle Use	Control voltage 14.5 - 14.9V; Initial current 6.4A or smaller
-----------	---

Residual capacity test result

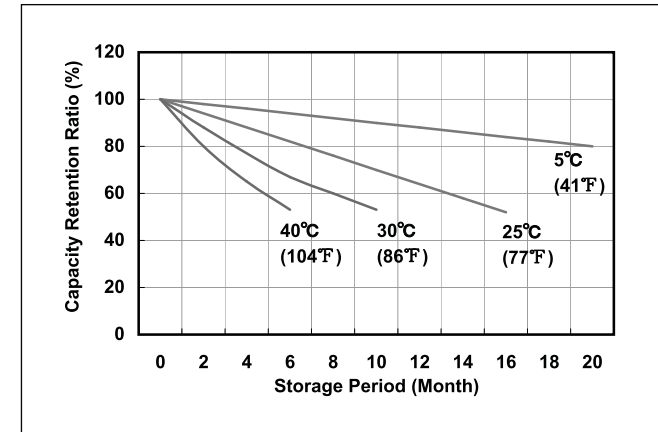

Cut off voltage

Discharge current	0.800A - 3.20A	3.20A - 8A	8A - 16A	16A - 32A	32A - 48A
Cut off voltage (V)	10.5	10.2	9.9	9.3	8.7

Cycle life vs. Depth of discharge

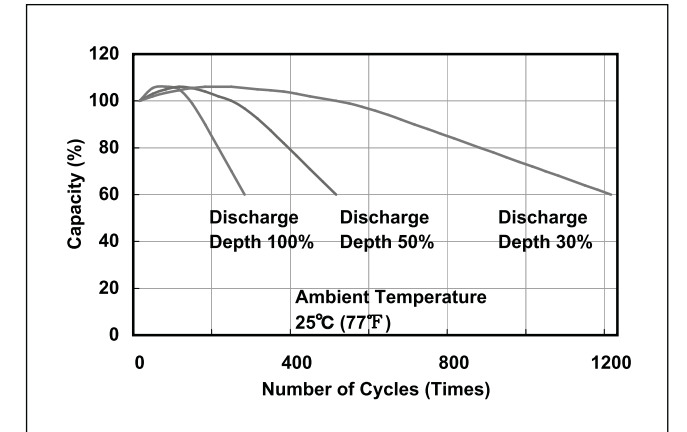

Constant-voltage and constant-current charge characteristics

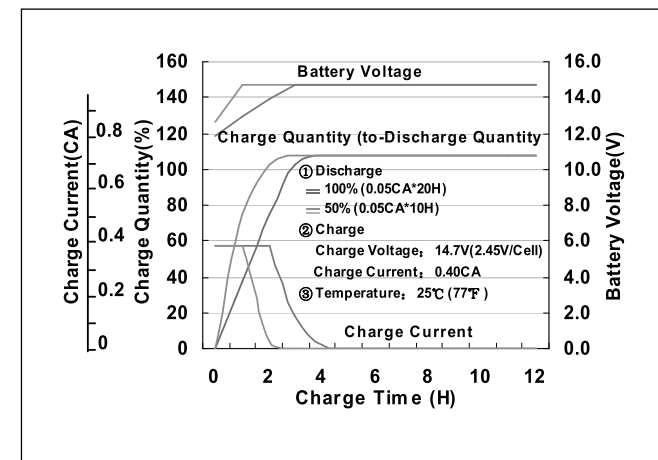

Discharge capacity by temperature and by discharge current

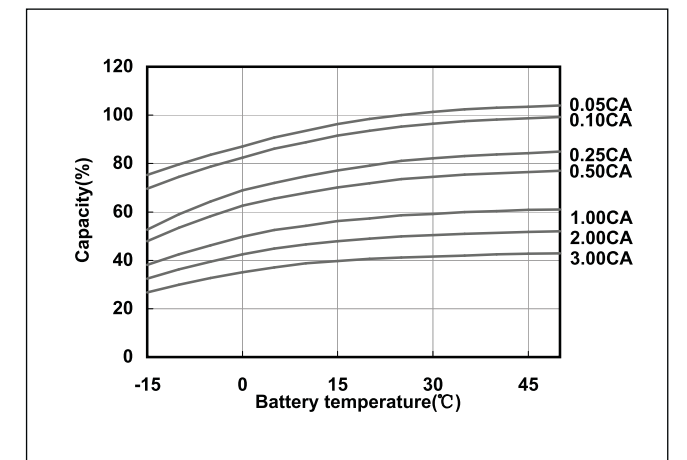

Discharge characteristics (25°C)

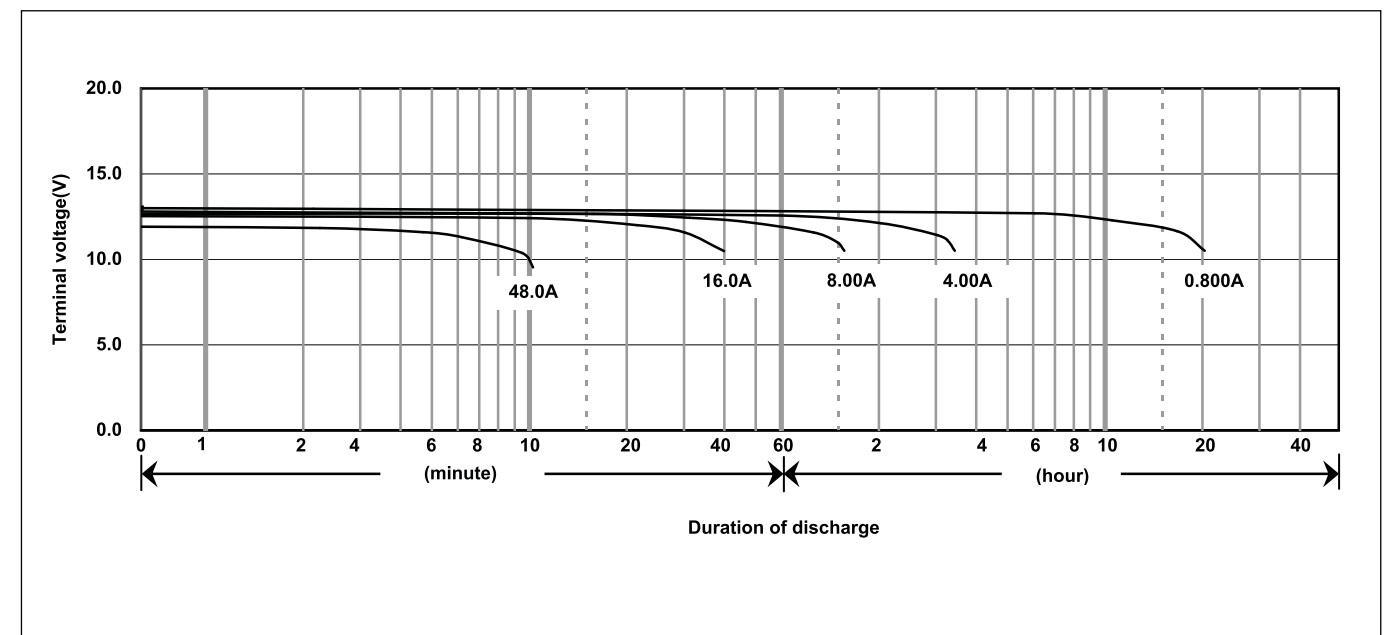

LC-XC1222P

For main power supplies.
Cycle long life type.

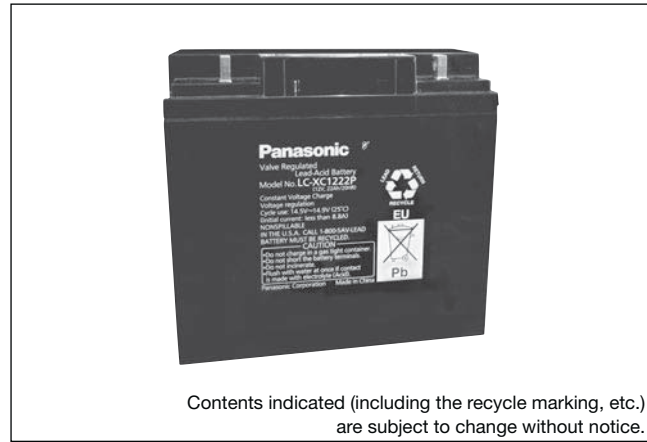

Contents indicated (including the recycle marking, etc.) are subject to change without notice.

Dimensions (mm)

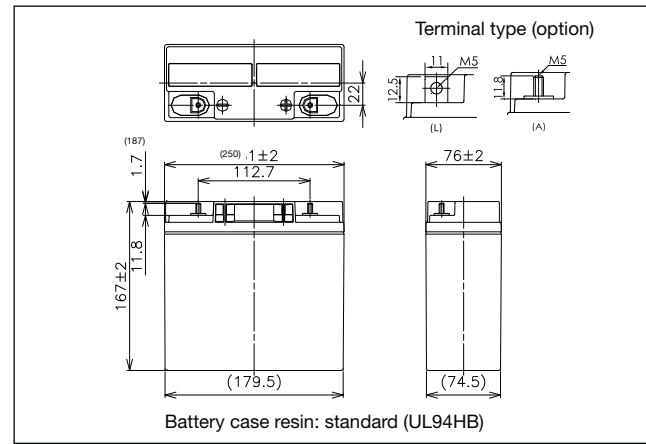

Battery case resin: standard (UL94HB)

Specifications

Nominal voltage	12V	
Nominal capacity (20 hour rate)	22Ah	
Dimensions	Length	181mm
	Width	76mm
	Height	167mm
	Total Height	167mm
Approx. mass	6.55kg	
Terminal	M5 threaded post Bolt and Nut type	

Duration of discharge vs Discharge current

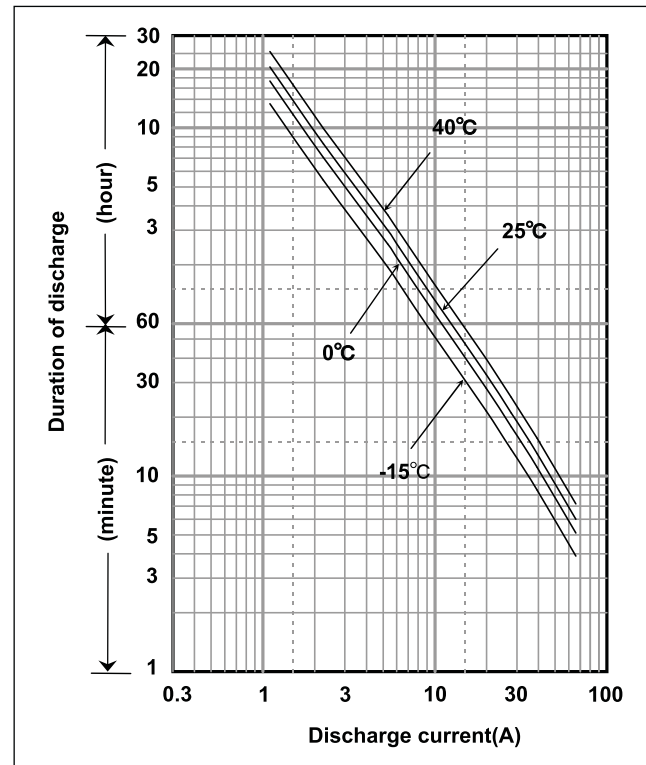

Characteristics

Capacity (25°C)	20 hour rate	22.0Ah
	10 hour rate	19.5Ah
	5 hour rate	17.5Ah
	1 hour rate	13.0Ah
Internal resistance	Fully charged battery (25°C)	12mΩ
Temperature dependency of capacity (20 hour rate)	40°C	102%
	25°C	100%
	0°C	85%
	-15°C	65%
Self discharge (25°C)	After 3 months	91%
	After 6 months	82%
	After 12 months	64%

Watt Table

(Wattage/Battery)

Cut-off V	10min	15min	20min	30min	45min	1h	1.5h	2h	3h	4h	5h	6h	10h	20h	24h
9.6V	618	472	396	295	213	170	117	93.2	69.4	53.3	44.0	35.4	24.0	13.0	10.8
9.9V	605	469	389	292	211	170	115	92.5	69.0	53.0	43.7	35.2	23.9	13.0	10.8
10.2V	590	459	383	289	209	167	112	90.1	68.3	52.6	43.3	35.0	23.6	12.9	10.8
10.5V	546	427	363	282	206	163	110	87.0	67.3	52.3	43.0	34.5	23.5	12.9	10.7
10.8V	487	399	354	272	203	160	107	82.8	65.9	51.6	41.9	34.0	23.3	12.8	10.7

Ampere Table

(Ampere/Battery)

Cut-off V	10min	15min	20min	30min	45min	1h	1.5h	2h	3h	4h	5h	6h	10h	20h	24h
9.6V	59.4	43.0	36.7	25.4	18.8	14.5	9.79	7.55	5.85	4.48	3.69	2.96	2.05	1.11	0.926
9.9V	58.2	42.7	36.1	25.1	18.7	14.5	9.59	7.49	5.82	4.45	3.66	2.95	2.04	1.11	0.923
10.2V	56.7	41.8	35.5	24.8	18.5	14.2	9.40	7.30	5.76	4.42	3.63	2.93	2.02	1.10	0.920
10.5V	52.6	38.9	33.7	24.3	18.2	13.9	9.20	7.05	5.68	4.39	3.60	2.89	2.01	1.10	0.917
10.8V	46.9	36.3	32.8	23.4	17.9	13.6	8.95	6.71	5.56	4.33	3.51	2.84	1.99	1.09	0.911

Charging Method

Cycle Use	Control voltage 14.5 - 14.9V; Initial current 8.8A or smaller
-----------	---

Cut off voltage

Discharge current	1.1A - 4.4A	4.4A - 11A	11A - 22A	22A - 44A	44A - 66A
Cut off voltage (V)	10.5	10.2	9.9	9.3	8.7

Residual capacity test result

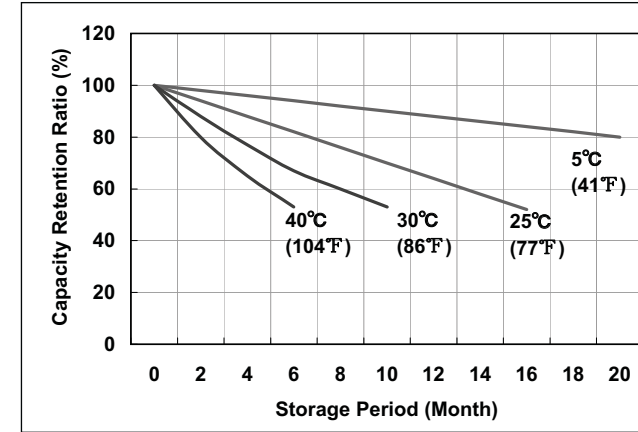

Cycle life vs. Depth of discharge

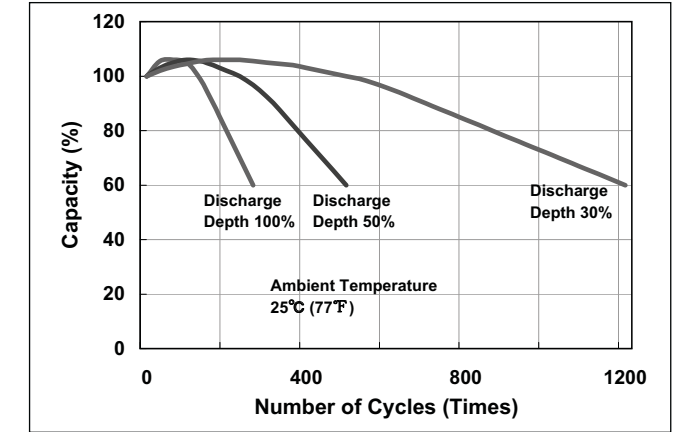

Constant-voltage and constant-current charge characteristics

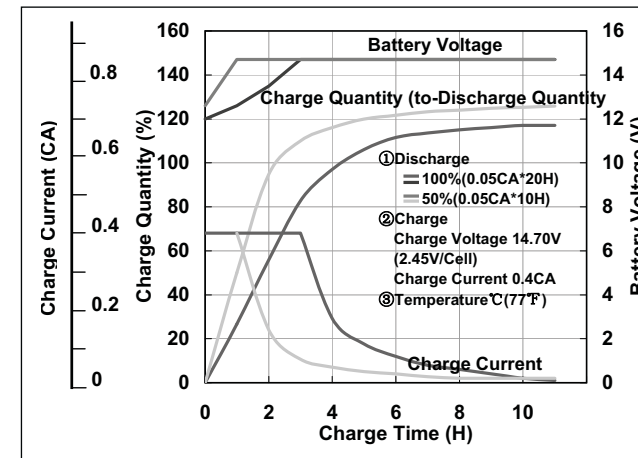

Discharge capacity by temperature and by discharge current

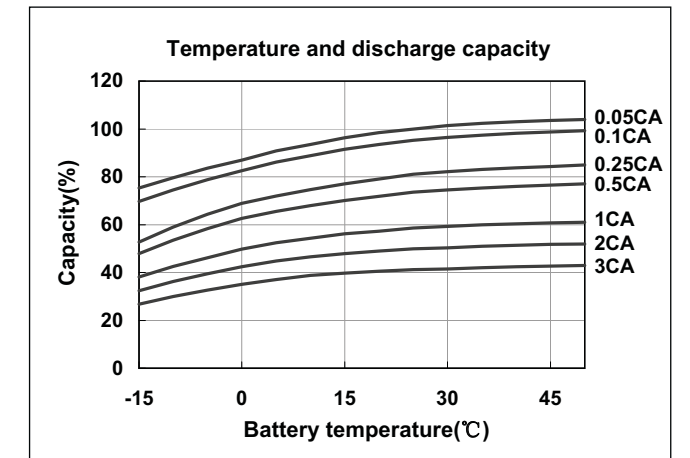

Discharge characteristics (25°C)

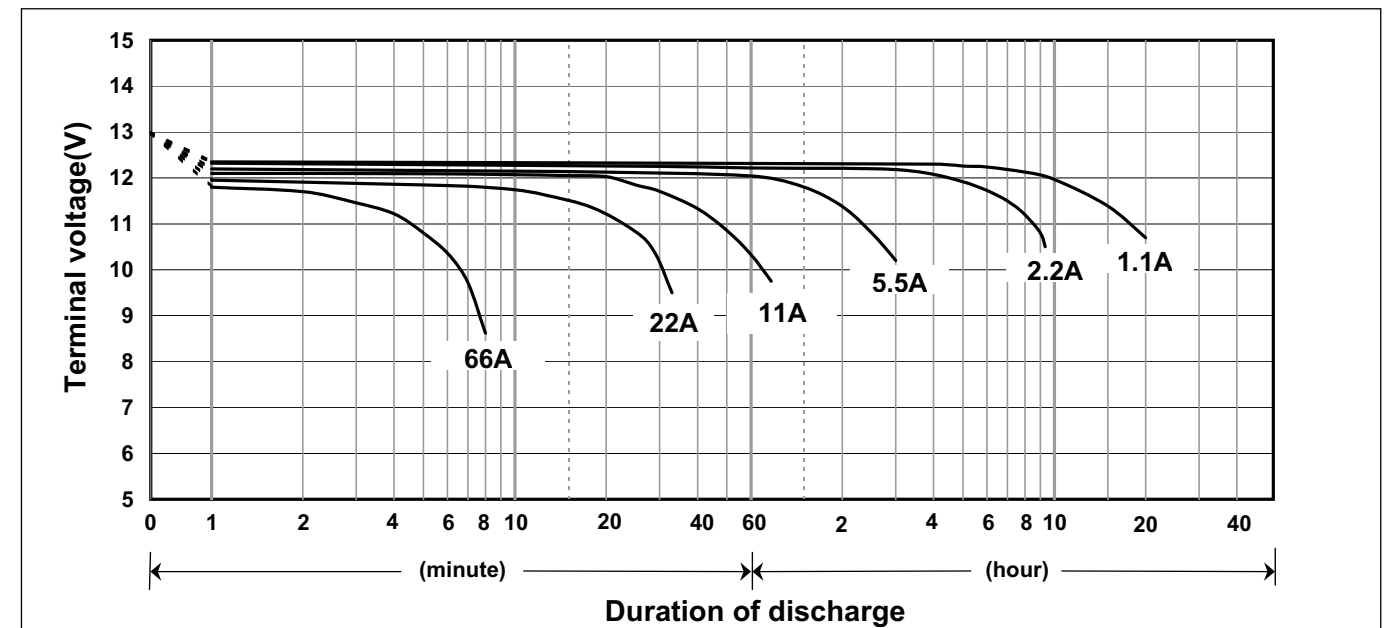

LC-XC1228P

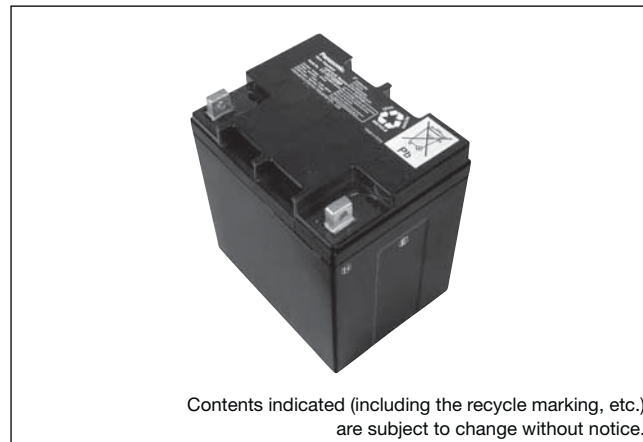

For main power supplies.
Cycle long life type.

Dimensions (mm)

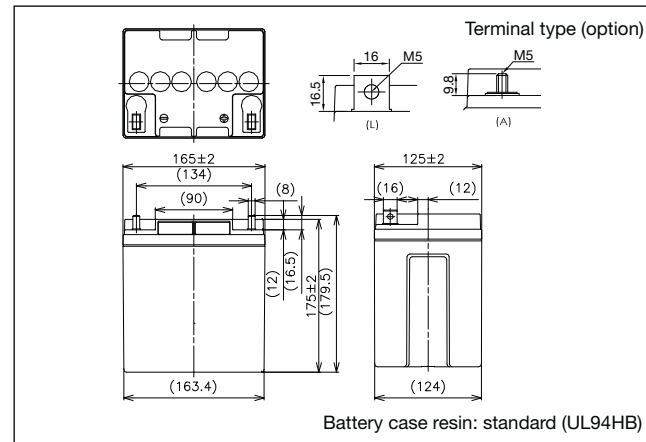

Specifications

Nominal voltage	12V	
Nominal capacity (20 hour rate)	28Ah	
Dimensions	Length	165mm
	Width	125mm
	Height	175mm
	Total Height	179.5mm
Approx. mass	10kg	
Terminal	M5 Bolt and Nut type	

Duration of discharge vs Discharge current

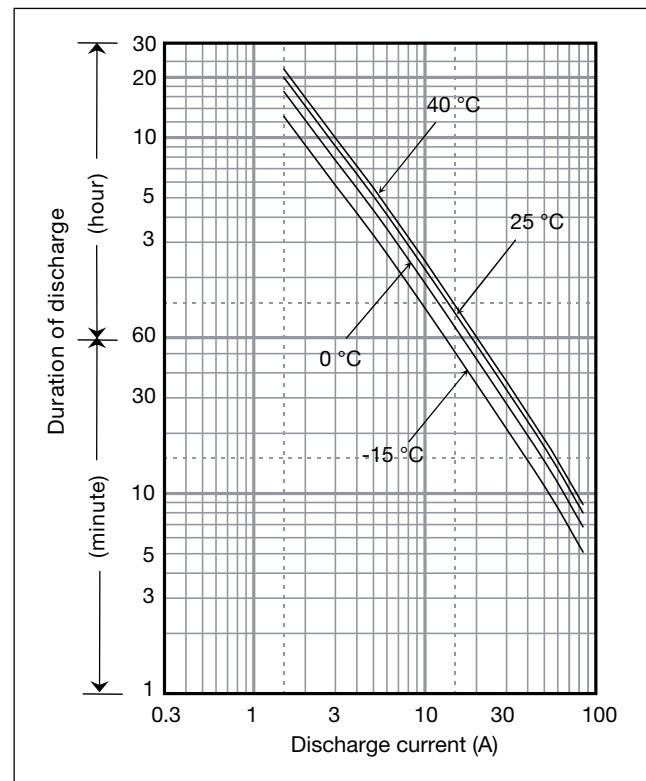

Characteristics

Capacity (25°C)	20 hour rate	28.0Ah
	10 hour rate	26.5Ah
	5 hour rate	25.0Ah
	1 hour rate	21.0Ah
Internal resistance	Fully charged battery (25°C)	8mΩ
Temperature dependency of capacity (20 hour rate)	40°C	102%
	25°C	100%
	0°C	85%
	-15°C	65%
Self discharge (25°C)	After 3 months	91%
	After 6 months	82%
	After 12 months	64%

Watt Table

Cut-off V	(Wattage/Battery)																	
	3min	5min	10min	15min	20min	30min	45min	1h	1.5h	2h	3h	4h	5h	6h	10h	20h	24h	
9.6V	1423	1160	865	664	585	410	304	260	159	129	91.6	74.1	61.1	52.8	31.8	16.8	14.0	
9.9V	1357	1093	849	654	579	404	294	254	156	128	90.4	72.9	59.9	51.6	31.8	16.8	14.0	
10.2V	1301	1026	818	643	567	397	294	251	155	127	89.3	71.7	59.9	51.6	31.8	16.8	14.0	
10.5V	1201	976	784	621	545	386	282	247	154	126	88.1	71.7	59.9	51.6	31.8	16.8	14.0	
10.8V	1052	903	773	610	539	374	255	218	149	118	84.5	70.5	59.9	50.4	31.8	16.8	13.9	

Ampere Table

Cut-off V	(Ampere/Battery)																	
	3min	5min	10min	15min	20min	30min	45min	1h	1.5h	2h	3h	4h	5h	6h	10h	20h	24h	
9.6V	128	104	77.2	57.7	50.4	35.0	25.9	22.1	13.5	10.9	7.7	6.20	5.10	3.40	2.65	1.40	1.17	
9.9V	122	98	75.8	56.9	49.9	34.5	25.0	21.6	13.2	10.8	7.6	6.10	5.00	4.30	2.65	1.40	1.17	
10.2V	117	92	73.0	55.9	48.9	33.9	25.0	21.3	13.1	10.7	7.5	6.00	5.00	4.30	2.65	1.40	1.17	
10.5V	108	88	70.0	54.0	47.0	33.0	24.0	21.0	13.0	10.6	7.4	6.00	5.00	4.30	2.70	1.40	1.17	
10.8V	95	81	69.0	53.0	46.5	32.0	21.7	18.5	12.6	10.0	7.1	5.90	5.00	4.20	2.65	1.40	1.16	

Charging Method

Trickle use	Control voltage: 14.5 - 14.9V; Initial current 11.2A or smaller
-------------	---

Cut off voltage

Discharge current	1.4A - 5.6A	5.6A - 14A	14A - 28A	28A - 56A	56A - 84A
Cut off voltage (V)	10.5	10.2	9.9	9.3	8.7

Residual capacity vs storage period

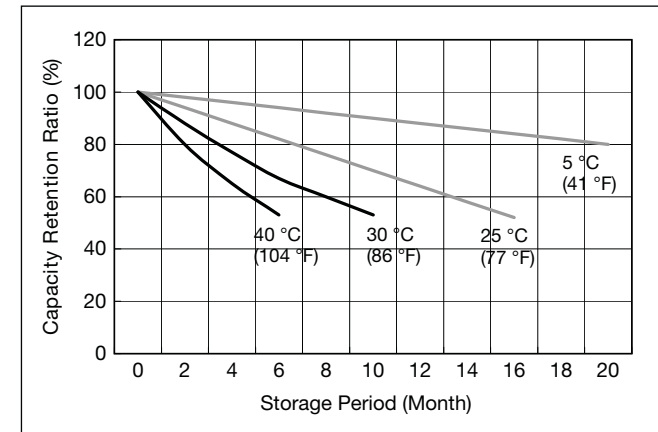

Cycle life vs Depth of discharge

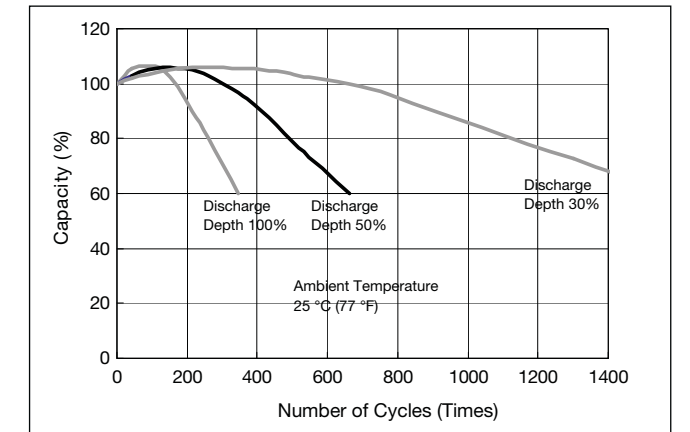

Constant-voltage and constant-current charge characteristics

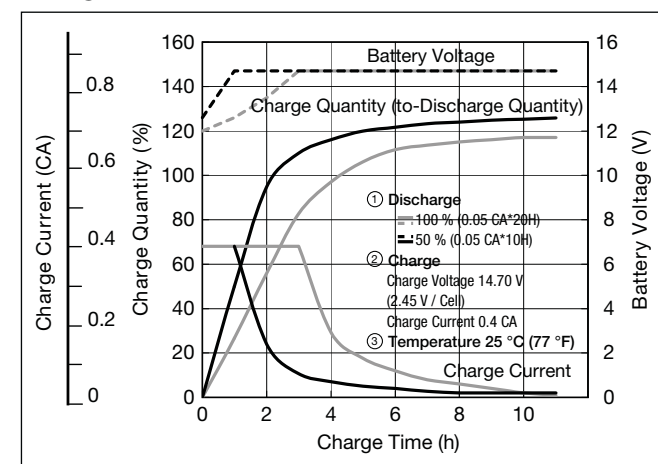

Discharge capacity by temperature and by discharge current

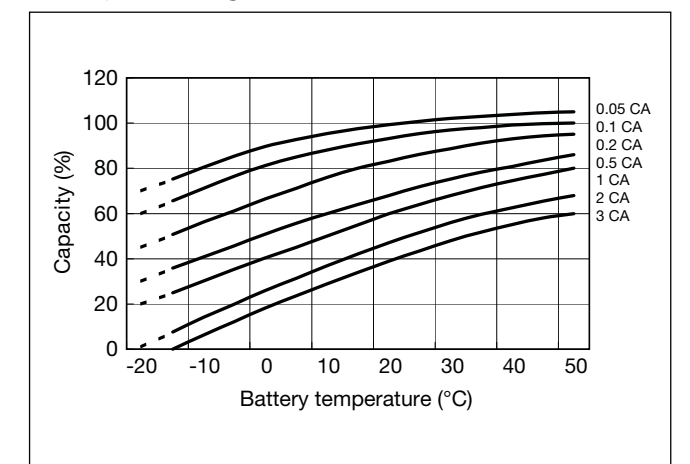

Discharge characteristics

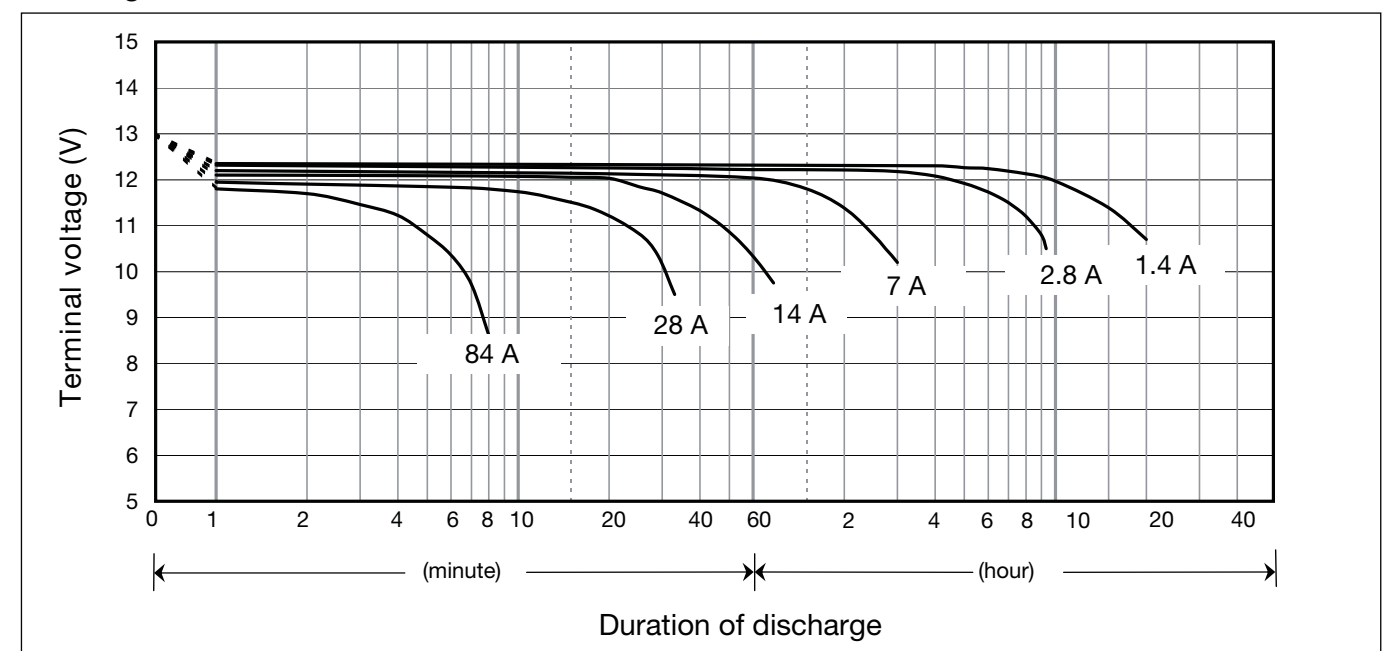

LC-XC1238P

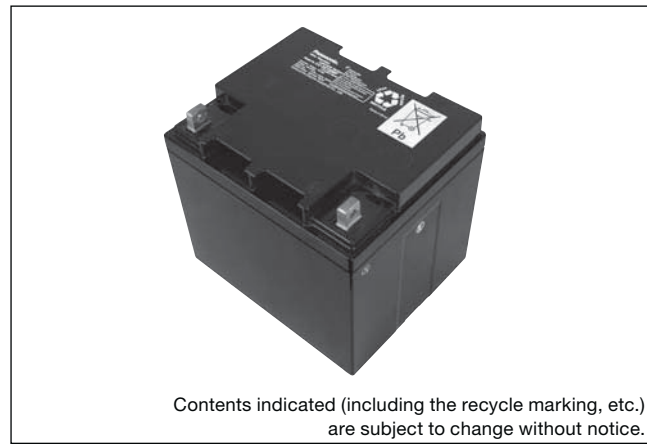

For main power supplies.
Cycle long life type.

Dimensions (mm)

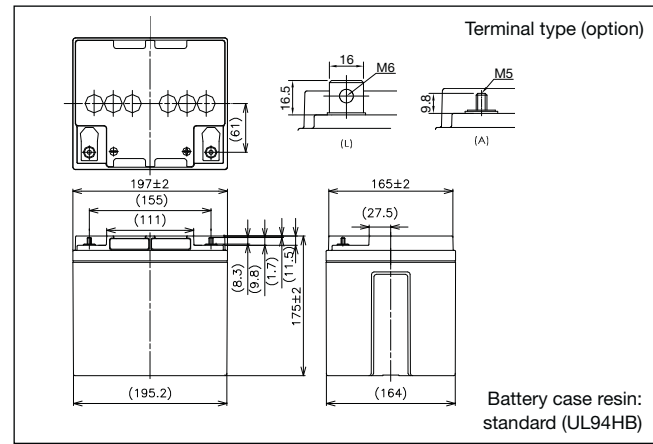

Specifications

Nominal voltage	12V	
Nominal capacity (20 hour rate)	38Ah	
Dimensions	Length	197mm
	Width	165mm
	Height	175mm
	Total Height	179.5mm
Approx. mass	15kg	
Terminal	M6 Bolt and Nut type	

Duration of discharge vs Discharge current

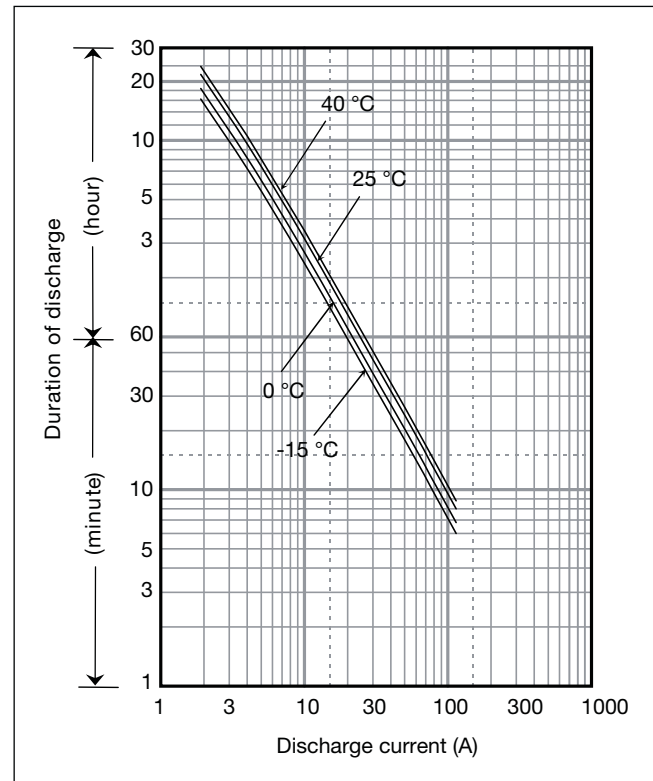

Characteristics

Capacity (25°C)	20 hour rate 10 hour rate 5 hour rate 1 hour rate	38Ah 36Ah 35Ah 23Ah
Internal resistance	Fully charged battery (25°C)	9mΩ
Temperature dependency of capacity (20 hour rate)	40°C 25°C 0°C -15°C	102% 100% 85% 65%
Self discharge (25°C)	After 3 months After 6 months After 12 months	91% 82% 64%

Watt Table

Cut-off V	(Wattage/Battery)																
	3min	5min	10min	15min	20min	30min	45min	1h	1.5h	2h	3h	4h	5h	6h	10h	20h	24h
9.6V	1668	1349	1030	800	686	505	351	276	214	169	123	99.2	77.9	68.3	42.0	22.8	19.0
9.9V	1535	1271	1008	788	682	500	350	269	209	168	120	98.0	76.7	68.3	42.0	22.8	19.0
10.2V	1457	1204	980	768	672	489	349	267	185	167	119	96.8	75.5	68.3	42.0	22.8	19.0
10.5V	1446	1126	952	748	661	480	346	265	183	166	119	96.8	75.5	68.3	42.0	22.8	19.0
10.8V	1311	1098	874	716	640	468	308	247	175	155	114	94.4	74.3	67.1	42.0	22.8	18.7

Ampere Table

Cut-off V	(Ampere/Battery)																
	3min	5min	10min	15min	20min	30min	45min	1h	1.5h	2h	3h	4h	5h	6h	10h	20h	24h
9.6V	150	121	92.0	69.6	59.1	43.2	29.9	23.4	18.1	14.3	10.3	8.30	6.50	5.70	3.50	1.90	1.58
9.9V	138	114	90.0	68.5	58.8	42.7	29.8	22.8	17.7	14.2	10.1	8.20	6.40	5.70	3.50	1.90	1.58
10.2V	131	108	87.5	66.8	57.9	41.8	29.7	22.7	15.7	14.1	10.0	8.10	6.30	5.70	3.50	1.90	1.58
10.5V	130	101	85.0	65.0	57.0	41.0	29.5	22.5	15.5	14.0	10.0	8.10	6.30	5.70	3.50	1.90	1.58
10.8V	118	98.5	78.0	62.3	55.2	40.0	26.2	21.0	14.8	13.1	9.6	7.90	6.20	5.60	3.50	1.90	1.56

Charging Method

Trickle use	Control voltage: 14.5 - 14.9V; Initial current 15.2A or smaller
-------------	---

Cut off voltage

Discharge current	1.9A - 7.6A	7.6A - 19A	19A - 38A	38A - 76A	76A - 114A
Cut off voltage (V)	10.5	10.2	9.9	9.3	8.7

Residual capacity vs storage period

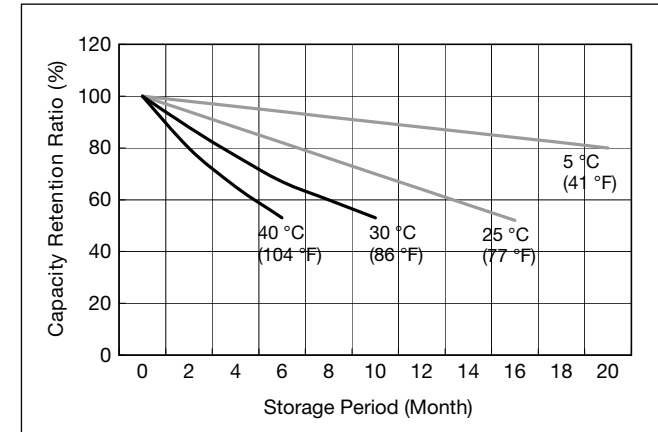

Cycle life vs Depth of discharge

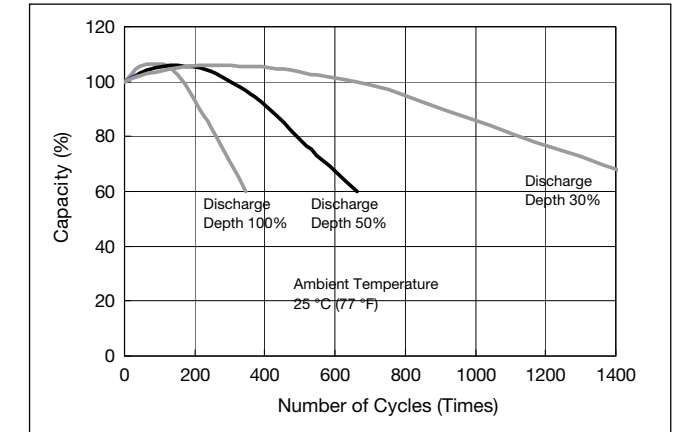

Constant-voltage and constant-current charge characteristics

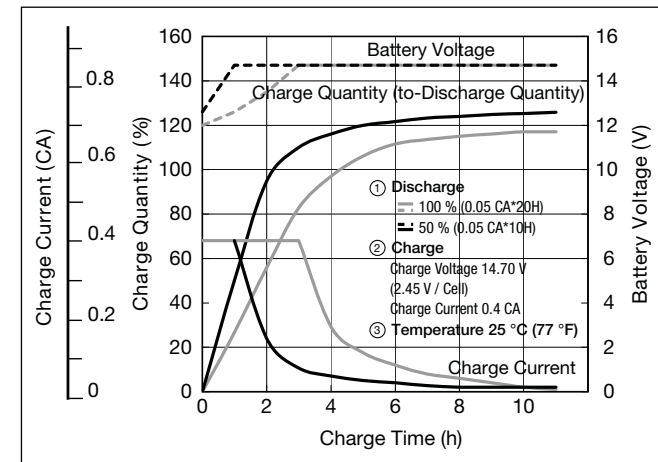

Discharge capacity by temperature and by discharge current

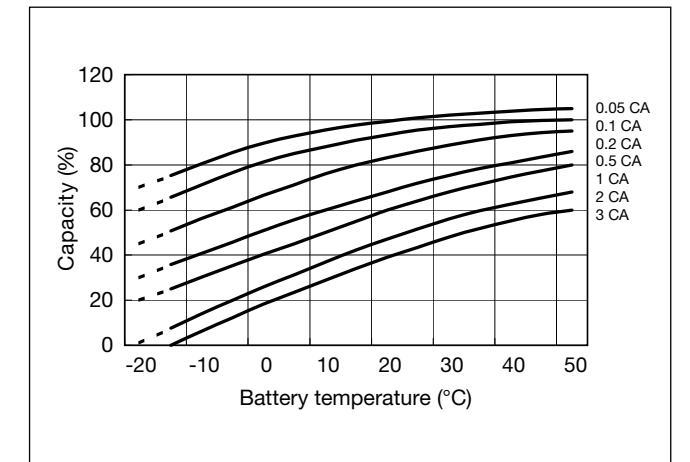

Discharge characteristics

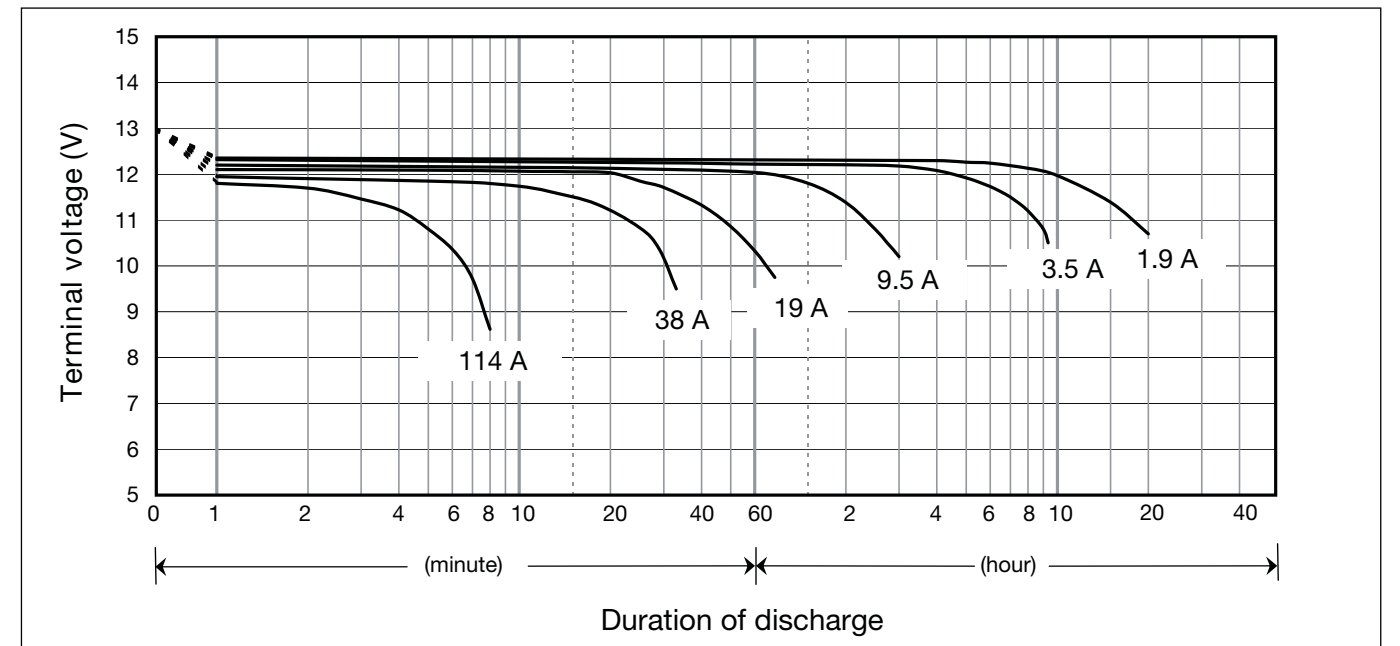

UP-RW0645P*1



Contents indicated (including the recycle marking, etc.) are subject to change without notice.

For standby power supplies.
Expected trickle design life: 6 – 9 years at 20°C according to Eurobat.

Dimensions (mm)

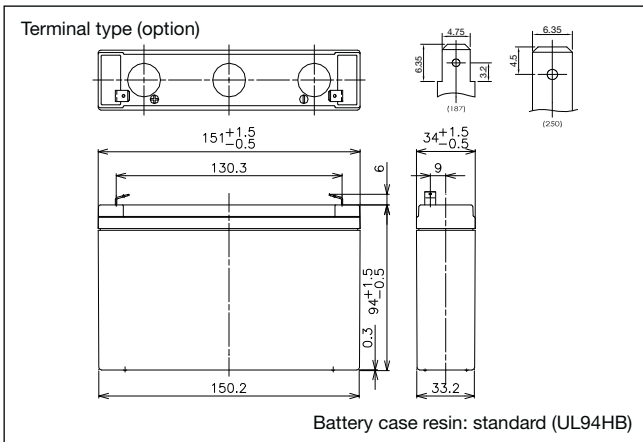

Specifications

Nominal voltage	6V	
Nominal capacity (10 minute rate)	135W	
Dimensions	Length	151mm
	Width	34mm
	Height	94mm
	Total Height	100mm
Approx. mass	1.3kg	
Terminal	Faston 187 or Faston 250 with hole	

Characteristics

Capacity (25°C)	20 hour rate	56W
	10 hour rate	97W
	5 hour rate	134W
	1 hour rate	205W
Internal resistance	Fully charged battery (25°C)	10mΩ
Temperature dependency of capacity (20 hour rate)	40°C	102%
	25°C	100%
	0°C	85%
	-15°C	65%
Self discharge (25°C)	After 3 months	91%
	After 6 months	82%
	After 12 months	64%

Duration of discharge vs Discharge current

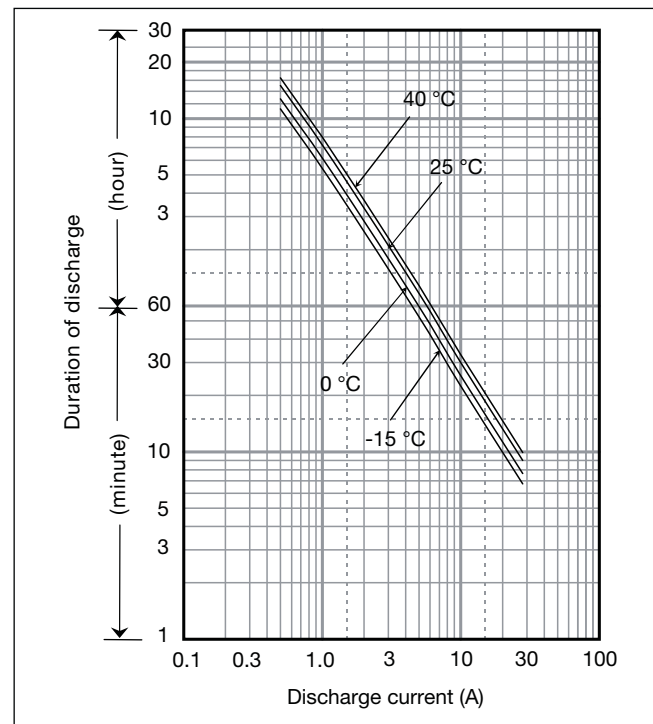

Watt Table

Cut-off V	(Wattage/Battery)																
	3min	5min	10min	15min	20min	30min	45min	1h	1.5h	2h	3h	4h	5h	6h	10h	20h	24h
4.8V	265	205	134	97.5	79.5	56.0	41.1	32.8	22.6	17.5	13.0	10.0	8.25	6.63	4.39	2.38	1.99
4.95V	254	200	131	97.2	78.9	55.9	40.8	32.8	22.1	17.3	12.9	9.92	8.18	6.60	4.37	2.37	1.98
5.1V	245	195	129	96.5	78.0	55.5	40.4	32.2	21.7	16.9	12.8	9.86	8.12	6.55	4.33	2.37	1.97
5.25V	231	180	123	93.4	75.4	55.0	39.3	31.5	20.8	16.4	12.8	9.85	8.07	6.48	4.31	2.36	1.97
5.4V	217	165	117	90.0	73.0	54.5	39.1	30.9	20.6	15.5	12.4	9.66	7.85	6.37	4.26	2.35	1.95

Ampere Table

Cut-off V	(Ampere/Battery)																
	3min	5min	10min	15min	20min	30min	45min	1h	1.5h	2h	3h	4h	5h	6h	10h	20h	24h
4.8V	47.7	36.8	23.9	17.0	13.7	9.6	6.99	5.57	3.82	2.95	2.19	1.67	1.38	1.11	0.732	0.397	0.331
4.95V	45.8	35.9	23.5	16.9	13.6	9.6	6.95	5.57	3.75	2.93	2.17	1.66	1.37	1.10	0.729	0.396	0.330
5.1V	44.1	35.0	23.0	16.8	13.5	9.5	6.88	5.46	3.67	2.86	2.15	1.65	1.36	1.09	0.721	0.394	0.329
5.25V	41.6	32.3	22.0	16.3	13.0	9.4	6.70	5.35	3.53	2.77	2.16	1.65	1.35	1.08	0.718	0.393	0.328
5.4V	39.0	29.6	20.9	15.7	12.6	9.3	6.67	5.25	3.50	2.62	2.08	1.62	1.31	1.06	0.710	0.391	0.326

*1 This battery is also available with a flame retardant battery case resin (UL94 V-0).

Charging Method

Trickle use	Control voltage: 6.8 - 6.9V; Initial current: 1.2A or smaller
-------------	---

Influence of Temperature on Trickle life

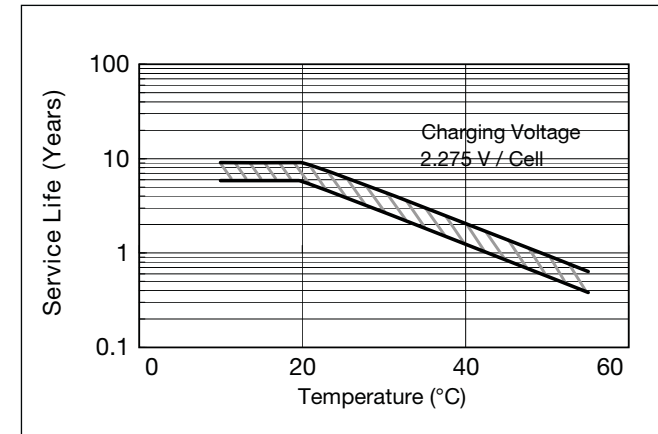

Cut off voltage

Discharge current	0.4A - 1.6A	1.6A - 4A	4A - 8A	8A - 16A	16A - 24A
Cut off voltage (V)	5.25	5.1	4.95	4.65	4.35

Residual capacity vs storage period

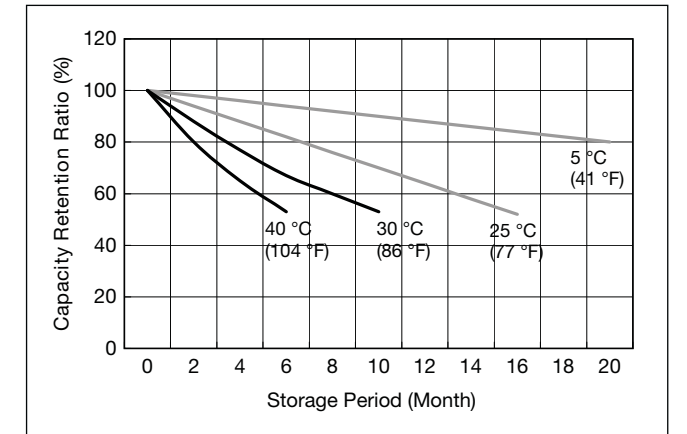

Constant-voltage and constant-current charge characteristics for Trickle use

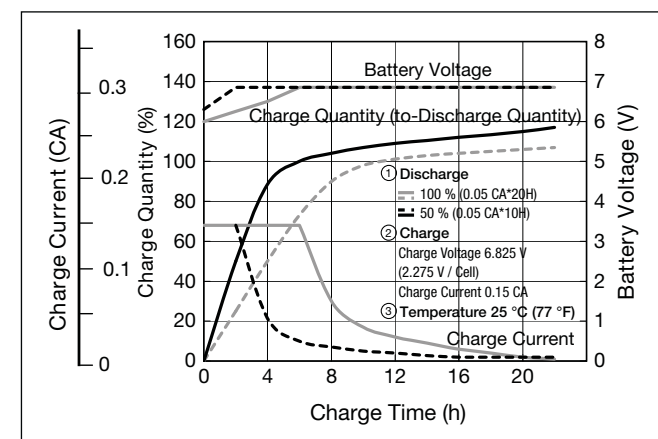

Discharge capacity by temperature and by discharge current

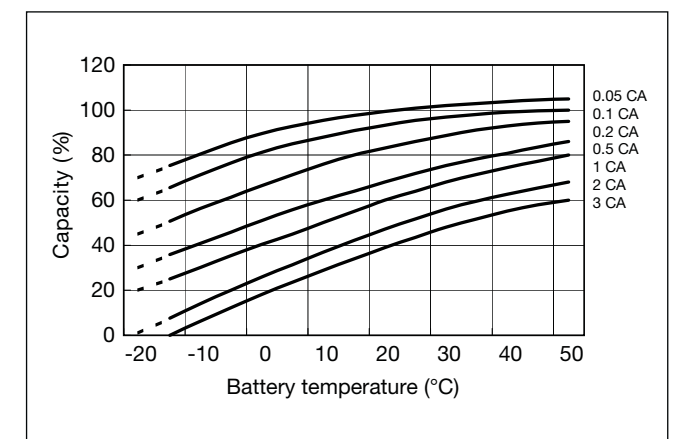

Discharge characteristics

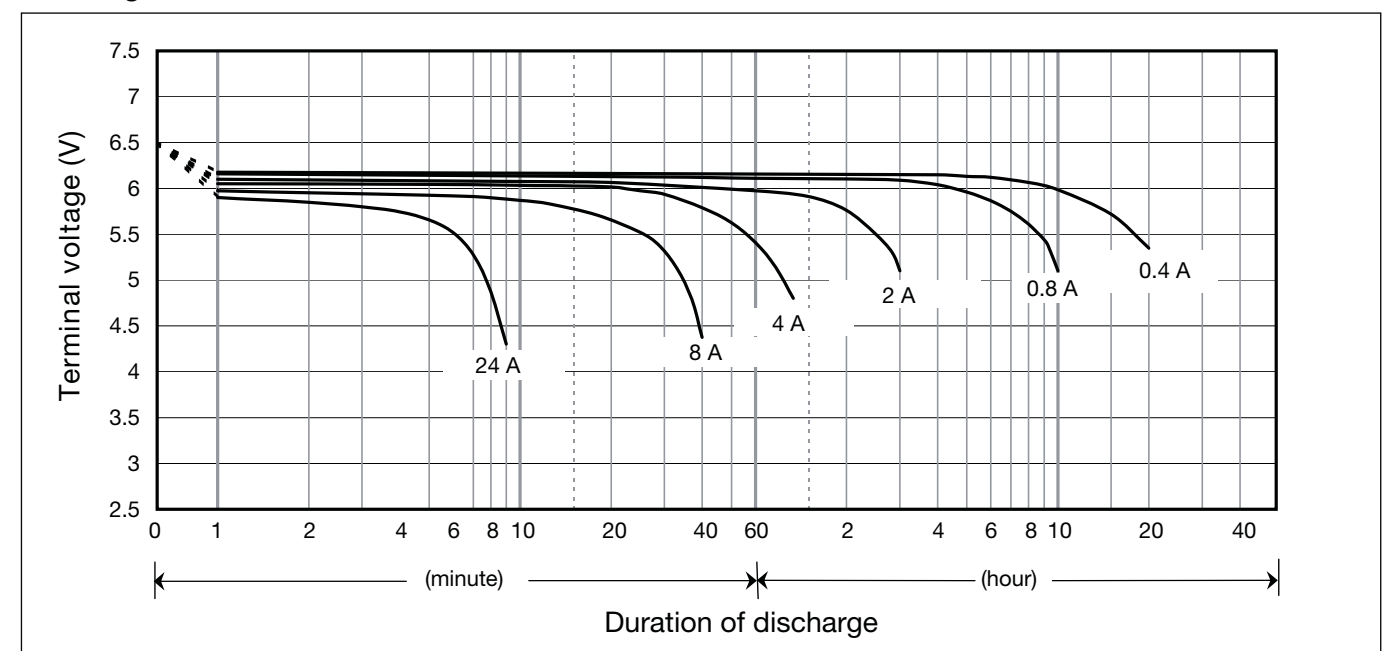

UP-RW1220P*1

For standby power supplies.
Expected trickle design life: 6 – 9 years at 20°C according to Eurobat.

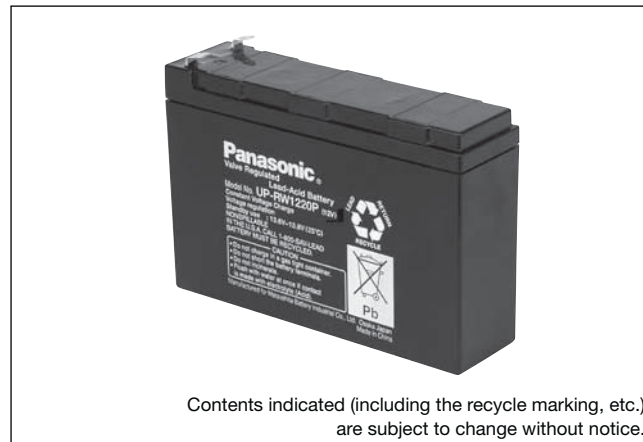

Dimensions (mm)

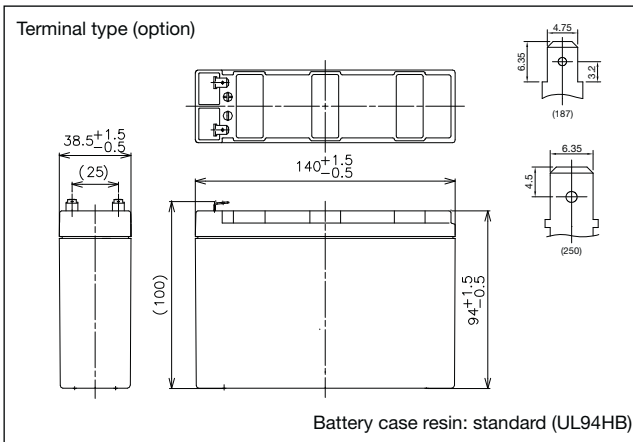

Specifications

Nominal voltage	12V	
Nominal capacity (10 minute rate)	120W	
Dimensions	Length	140mm
	Width	38.5mm
	Height	94mm
	Total Height	100mm
Approx. mass	1.35kg	
Terminal	Faston 187 or Faston 250 with hole	

Characteristics

Capacity (25°C)	20 hour rate	57W
	10 hour rate	91W
	5 hour rate	120W
	1 hour rate	180W
Internal resistance	Fully charged battery (25°C)	44mΩ
Temperature dependency of capacity (20 hour rate)	40°C	102%
	25°C	100%
	0°C	85%
	-15°C	65%
Self discharge (25°C)	After 3 months	91%
	After 6 months	82%
	After 12 months	64%

Duration of discharge vs Discharge current

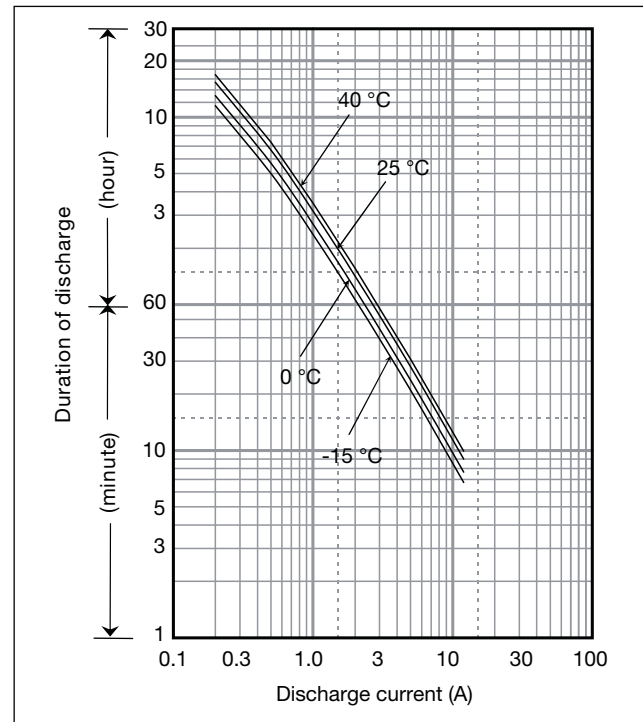

Watt Table

Cut-off V	(Wattage/Battery)																
	3min	5min	10min	15min	20min	30min	45min	1h	1.5h	2h	3h	4h	5h	6h	10h	20h	24h
9.6V	237	180	120	91.0	75.0	57.0	41.8	33.4	23.0	17.8	13.2	10.2	8.39	6.75	4.47	2.42	2.02
9.9V	227	173	116	89.1	74.0	58.4	39.3	31.6	21.3	16.7	12.5	9.56	7.88	6.36	4.21	2.29	1.91
10.2V	217	167	113	87.0	73.0	52.0	37.9	30.2	20.3	15.9	12.0	9.24	7.60	6.14	4.05	2.22	1.85
10.5V	197	152	108	84.5	69.5	49.5	35.4	28.3	18.7	14.8	11.6	8.86	7.26	5.83	3.88	2.12	1.77
10.8V	177	137	102	82.0	66.0	47.0	33.7	26.6	17.8	13.4	10.7	8.33	6.77	5.49	3.68	2.02	1.69

Ampere Table

Cut-off V	(Ampere/Battery)																
	3min	5min	10min	15min	20min	30min	45min	1h	1.5h	2h	3h	4h	5h	6h	10h	20h	24h
9.6V	21.3	16.1	10.7	7.91	6.47	4.87	3.56	2.84	1.95	1.50	1.11	0.85	0.70	0.56	0.373	0.202	0.169
9.9V	20.4	15.6	10.4	7.75	6.38	4.99	3.35	2.68	1.80	1.41	1.05	0.80	0.66	0.53	0.351	0.190	0.159
10.2V	19.5	15.0	10.1	7.57	6.29	4.44	3.23	2.56	1.72	1.34	1.01	0.77	0.63	0.51	0.338	0.185	0.154
10.5V	17.7	13.7	9.60	7.35	5.99	4.23	3.02	2.41	1.59	1.25	0.97	0.74	0.61	0.49	0.323	0.177	0.148
10.8V	15.9	12.3	9.11	7.13	5.69	4.02	2.87	2.26	1.51	1.13	0.90	0.70	0.57	0.46	0.306	0.169	0.140

*1 This battery is also available with a flame retardant battery case resin (UL94 V-0).

Charging Method

Trickle use Control voltage: 13.6 - 13.8V; Initial current: 0.6A or smaller

Influence of Temperature on Trickle life

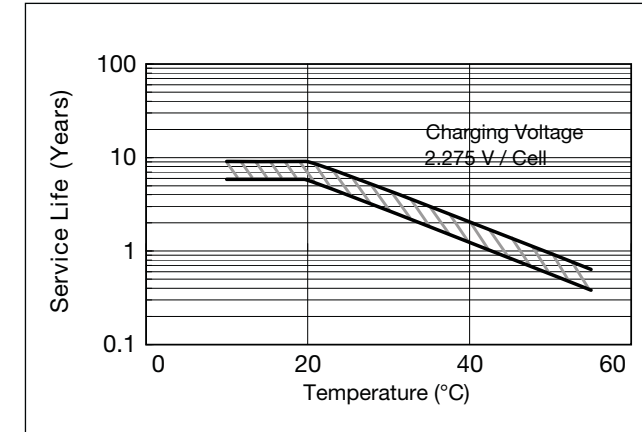

Cut off voltage

Discharge current	0.2A - 0.8A	0.8A - 2A	2A - 4A	4A - 8A	8A - 12A
Cut off voltage (V)	10.5	10.2	9.9	9.3	8.7

Residual capacity vs storage period

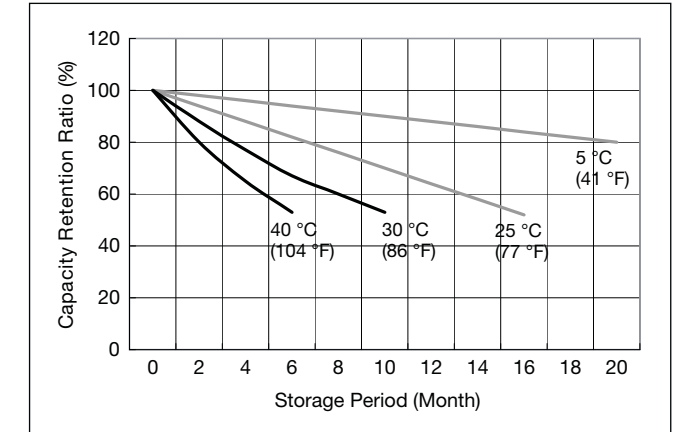

Constant-voltage and constant-current charge characteristics for Trickle use

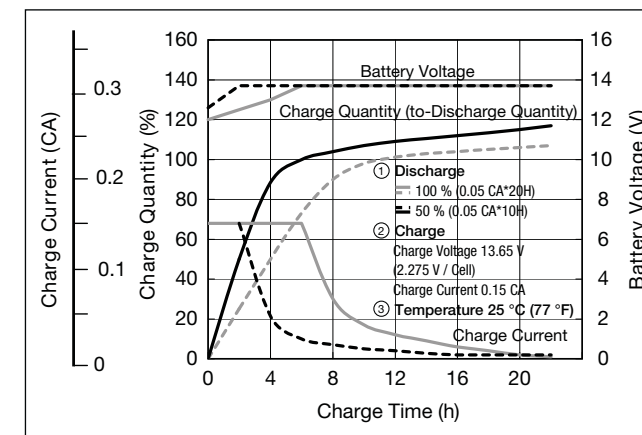

Discharge capacity by temperature and by discharge current

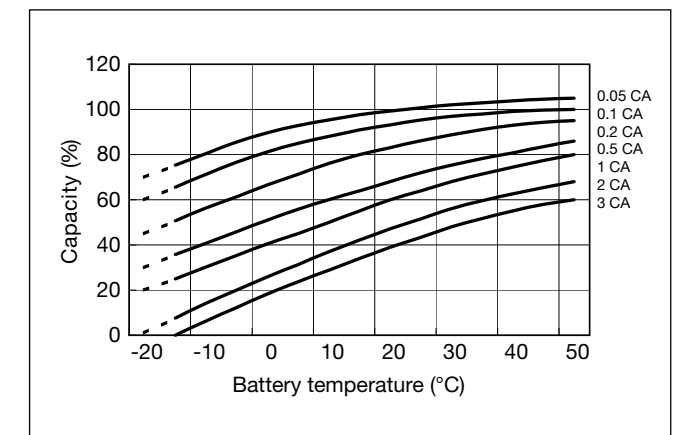

Discharge characteristics

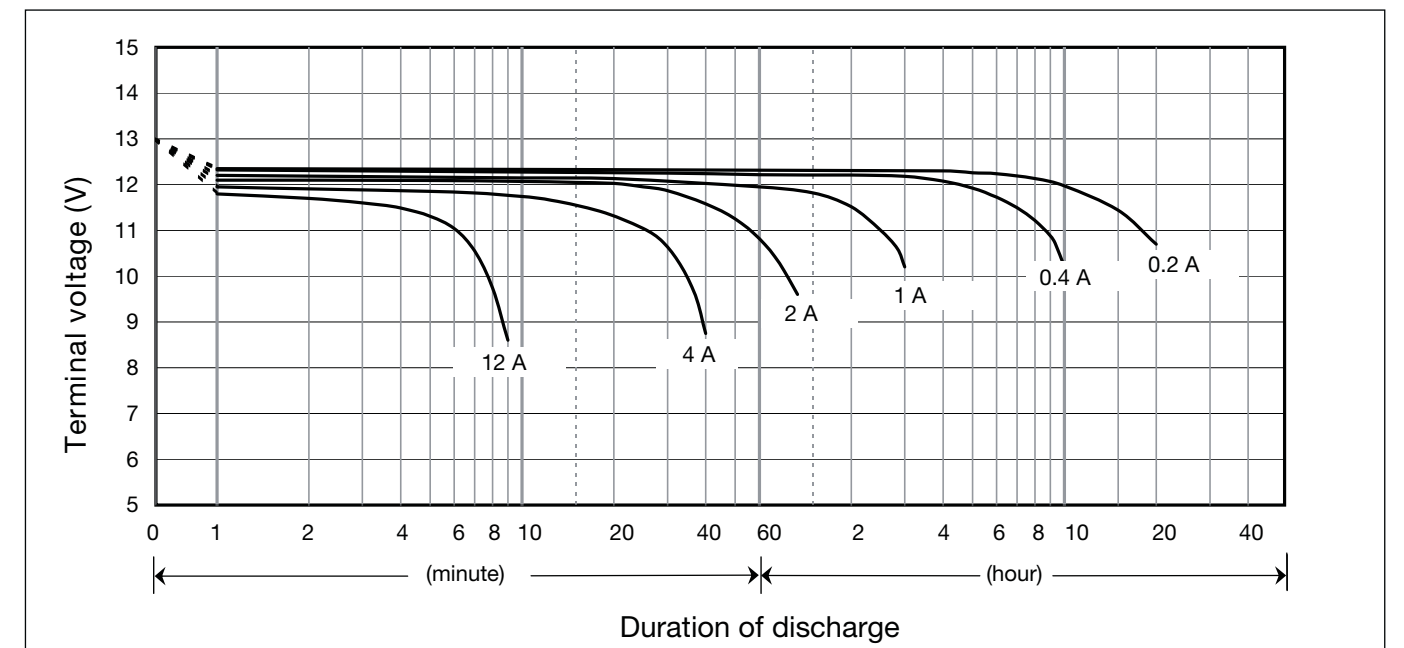

UP-RW1228P*1

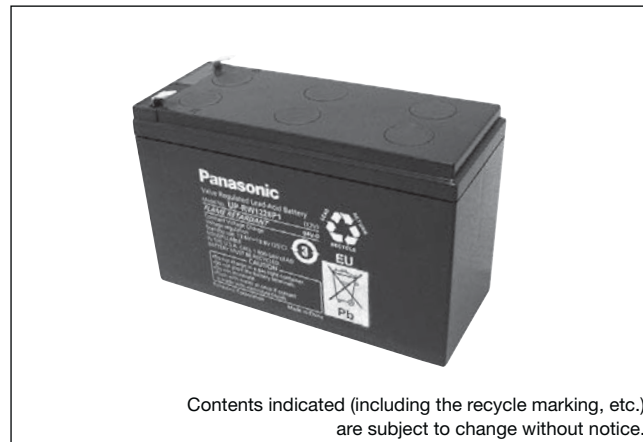

For standby power supplies.
Expected trickle design life: 6 – 9 years at 20°C according to Eurobat.

Dimensions (mm)

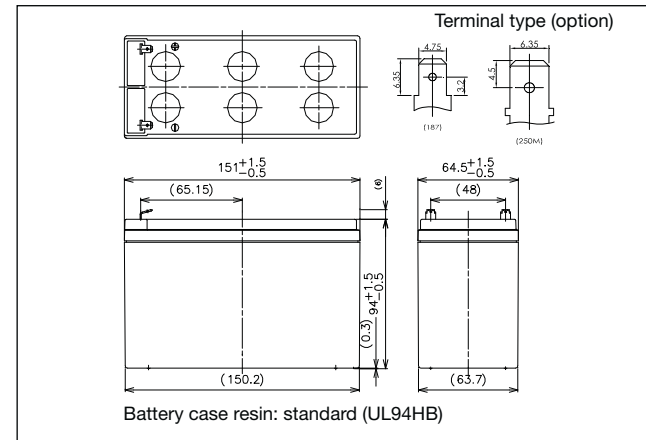

Specifications

Nominal voltage	12V	
Nominal capacity (10 minute rate)	200W	
Dimensions	Length	151mm
	Width	64.5mm
	Height	94mm
	Total Height	100mm
Approx. mass	1.85kg	
Terminal	Faston 187 & 250M	

Characteristics

Capacity (25°C)	30 minute rate	80W
	15 minute rate	151W
	10 minute rate	200W
	5 minute rate	210W
Internal resistance	Fully charged battery (25°C)	23mΩ
Temperature dependency of capacity (20 hour rate)	40°C	102%
	25°C	100%
	0°C	85%
	-15°C	65%
Self discharge (25°C)	After 3 months	91%
	After 6 months	82%
	After 12 months	64%

Duration of discharge vs Discharge current

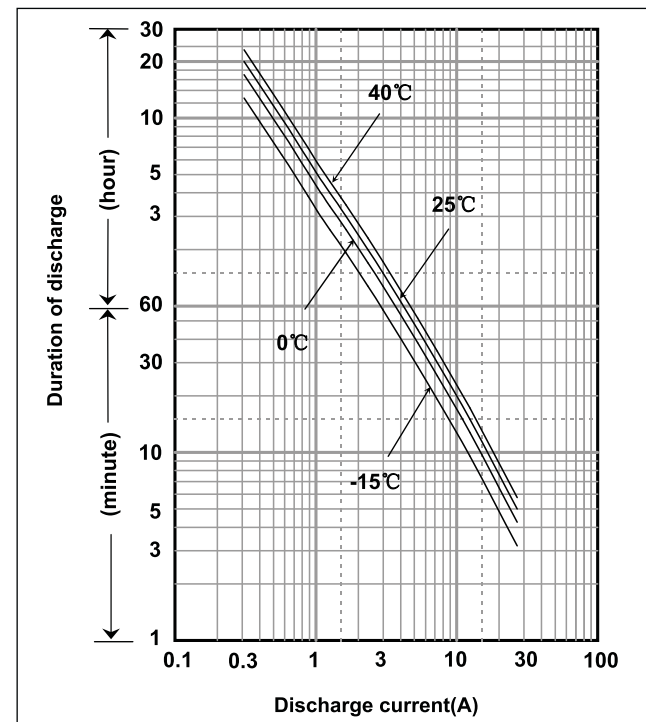

Watt Table

Cut-off V	(Wattage/Battery)																
	3min	5min	10min	15min	20min	30min	45min	1h	1.5h	2h	3h	4h	5h	6h	10h	20h	24h
9.6V	415	320	200	151	113	80.4	60.0	50.4	37.2	28.8	20.1	15.2	12.5	10.3	6.26	3.01	2.46
9.9V	391	274	170	144	109	78.7	59.6	49.2	36.4	28.6	20.0	15.1	12.4	10.1	6.23	3.00	2.46
10.2V	365	261	165	137	106	77.0	57.1	47.8	34.5	27.0	19.2	14.8	11.9	9.85	5.97	2.90	2.37
10.5V	331	237	158	131	101	74.1	55.6	46.8	33.2	26.2	18.8	14.5	11.8	9.75	5.94	2.89	2.36
10.8V	298	213	149	125	96.9	71.2	52.1	43.2	31.0	23.3	17.4	13.4	10.8	9.02	5.53	2.71	2.21

Ampere Table

Cut-off V	(Ampere/Battery)																
	3min	5min	10min	15min	20min	30min	45min	1h	1.5h	2h	3h	4h	5h	6h	10h	20h	24h
9.6V	35.6	26.9	16.6	13.2	10.7	8.01	5.86	4.67	3.20	2.47	1.83	1.40	1.15	0.926	0.613	0.332	0.277
9.9V	33.5	25.6	16.1	12.6	10.3	7.85	5.82	4.55	3.14	2.45	1.82	1.39	1.14	0.922	0.610	0.331	0.276
10.2V	31.4	24.4	15.7	11.9	10.0	7.68	5.58	4.43	2.97	2.32	1.74	1.34	1.10	0.885	0.584	0.320	0.266
10.5V	28.5	22.1	15.0	11.4	9.57	7.40	5.43	4.33	2.86	2.24	1.68	1.29	1.05	0.876	0.581	0.310	0.257
10.8V	25.6	19.9	14.2	10.9	9.17	7.11	5.08	4.00	2.67	2.00	1.58	1.23	1.00	0.810	0.542	0.298	0.248

*1 This battery is also available with a flame retardant battery case resin (UL94 V-0).

Charging Method

Trickle use	Control voltage: 13.6 - 13.8V; Initial current: 0.87A or smaller
-------------	--

Influence of Temperature on Trickle life

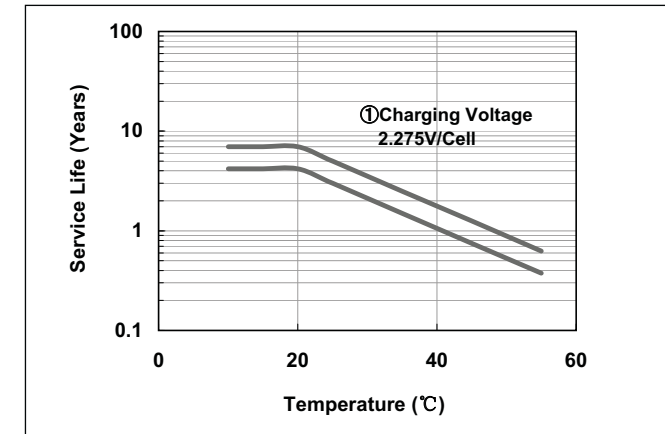

Cut off voltage

Discharge current	0.29A - 1.16A	1.16A - 2.9A	2.9A - 5.8A	5.8A - 11.6A	11.6A - 17.4A
Cut off voltage (V)	10.5	10.2	9.9	9.3	8.7

Residual capacity test result

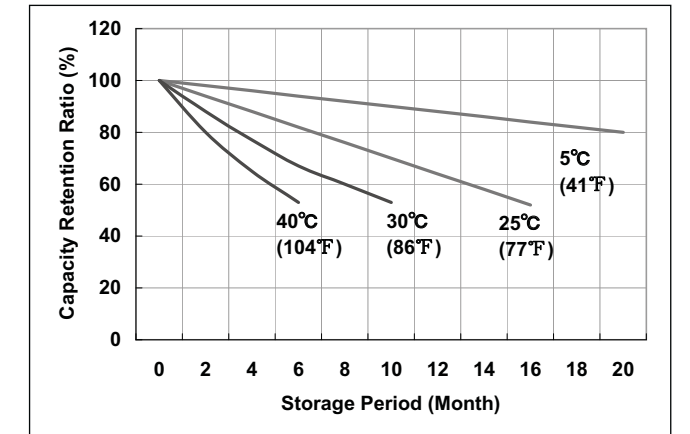

Constant-voltage and constant-current charge characteristics

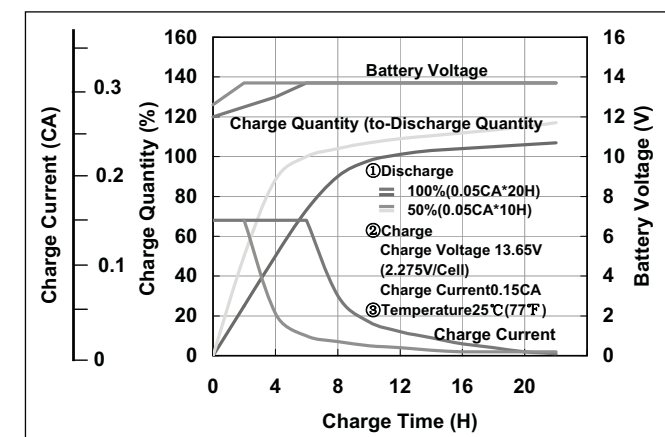

Discharge capacity by temperature and by discharge current

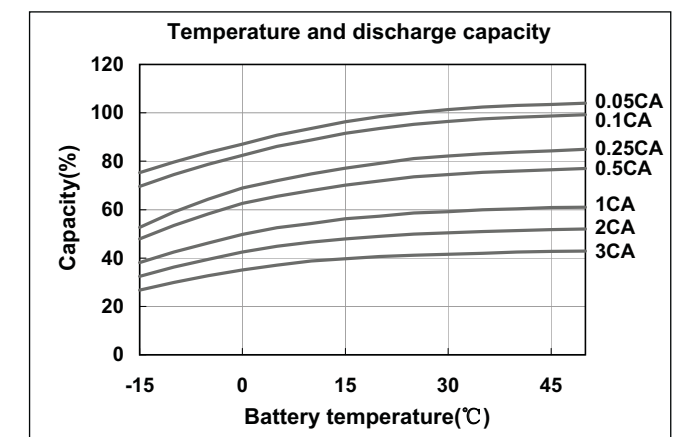

Discharge characteristics

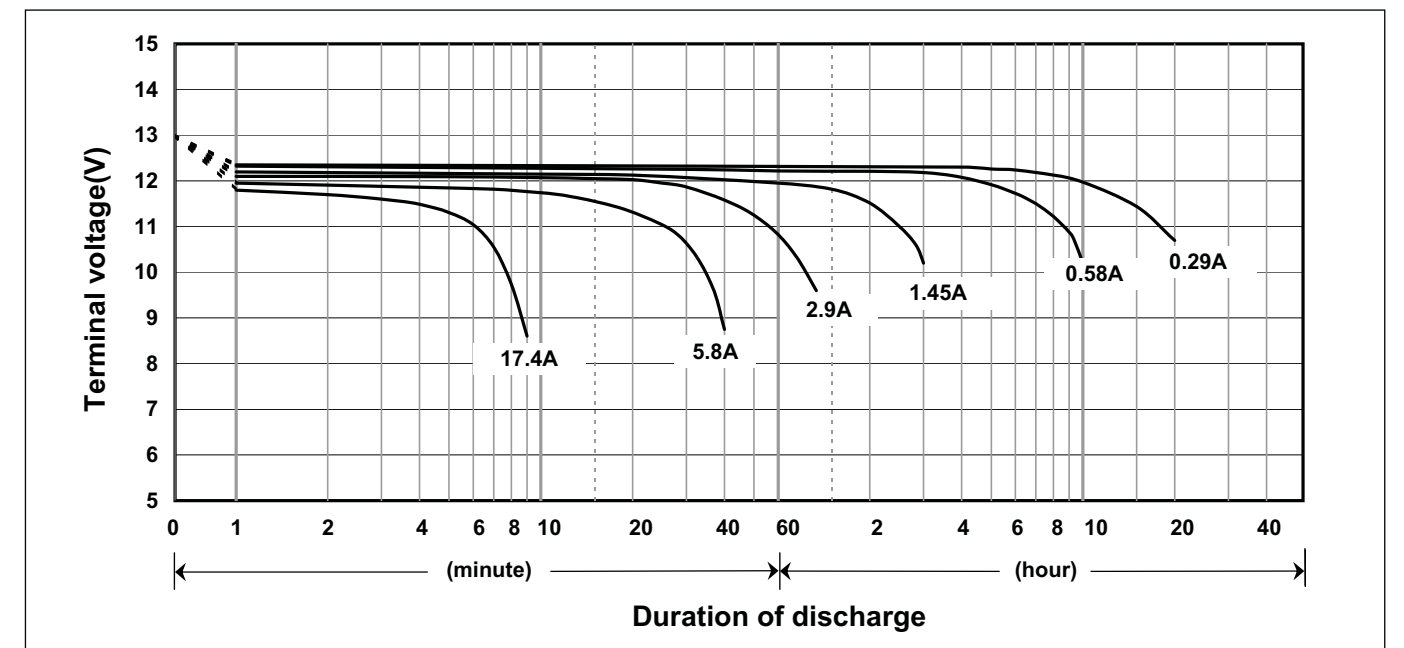

UP-RWA1232P1/P2*1

For standby power supplies.
Expected trickle design life: 6 – 9 years at 20°C according to Eurobat.



Dimensions (mm)

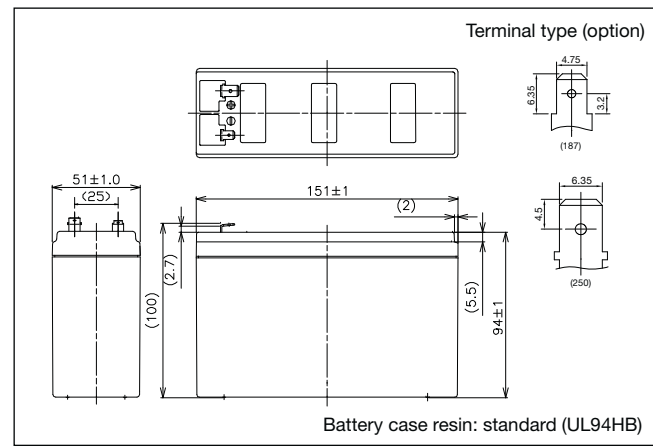

Specifications

Nominal voltage	12V	
Nominal capacity (10 minute rate)	192W	
Dimensions	Length	151mm
	Width	51mm
	Height	94mm
	Total Height	100mm
Approx. mass	2kg	
Terminal	Faston 250 with hole or Faston 187/250 mixed	

Duration of discharge vs Discharge current

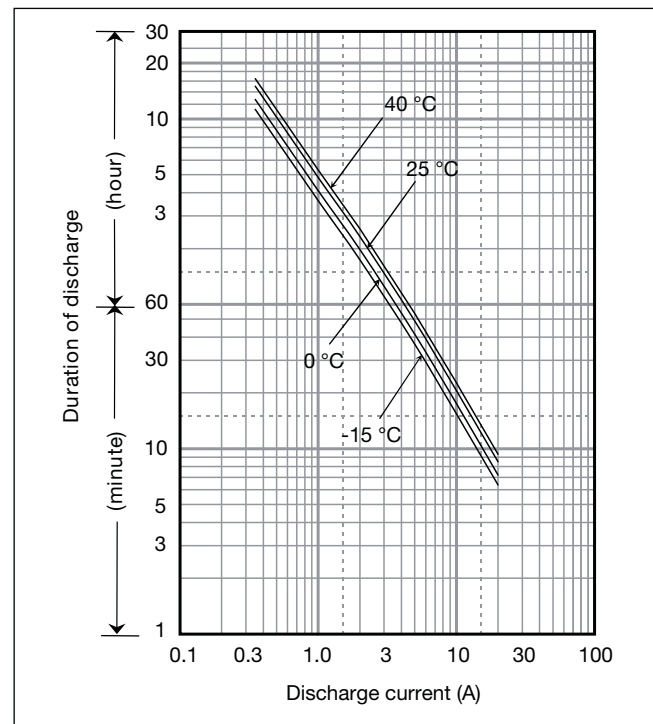

Characteristics

Capacity (25°C)	20 hour rate	97W
	10 hour rate	157W
	5 hour rate	192W
	1 hour rate	310W
Internal resistance	Fully charged battery (25°C)	33mΩ
Temperature dependency of capacity (20 hour rate)	40°C	102%
	25°C	100%
	0°C	85%
	-15°C	65%
Self discharge (25°C)	After 3 months	91%
	After 6 months	82%
	After 12 months	64%

Watt Table

Cut-off V	(Wattage/Battery)																
	3min	5min	10min	15min	20min	30min	45min	1h	1.5h	2h	3h	4h	5h	6h	10h	20h	24h
9.6V	410	310	192	157	128	97.0	71.1	56.9	39.1	30.3	22.5	17.3	14.3	11.5	7.61	4.12	3.44
9.9V	386	295	187	150	124	95.0	70.7	56.9	38.3	30.0	22.4	17.2	14.2	11.4	7.58	4.11	3.43
10.2V	361	281	182	142	120	93.0	67.7	53.9	36.3	28.4	21.5	16.5	13.6	11.0	7.25	3.97	3.31
10.5V	327	255	174	136	115	89.5	65.9	52.8	34.9	27.5	21.5	16.5	13.5	10.9	7.22	3.96	3.30
10.8V	294	230	164	130	110	86.0	61.7	48.8	32.6	24.5	19.5	15.2	12.4	10.0	6.73	3.70	3.08

Ampere Table

Cut-off V	(Ampere/Battery)																
	3min	5min	10min	15min	20min	30min	45min	1h	1.5h	2h	3h	4h	5h	6h	10h	20h	24h
9.6V	36.9	27.8	17.1	13.7	11.0	8.29	6.06	4.83	3.31	2.56	1.89	1.45	1.19	0.96	0.634	0.344	0.287
9.9V	34.7	26.5	16.7	13.0	10.7	8.12	6.02	4.83	3.25	2.54	1.88	1.44	1.18	0.95	0.631	0.343	0.286
10.2V	32.5	25.2	16.3	12.3	10.3	7.95	5.77	4.58	3.08	2.40	1.80	1.38	1.14	0.92	0.604	0.331	0.276
10.5V	29.5	22.9	15.5	11.8	9.9	7.65	5.61	4.48	2.96	2.32	1.81	1.38	1.13	0.91	0.602	0.330	0.275
10.8V	26.4	20.6	14.6	11.3	9.5	7.35	5.26	4.14	2.76	2.07	1.64	1.28	1.03	0.84	0.560	0.309	0.257

*1 This battery is also available with a flame retardant battery case resin (UL94 V-0).

Charging Method

Trickle use	Control voltage: 13.6 - 13.8V; Initial current: 1.05A or smaller
-------------	---

Influence of Temperature on Trickle life

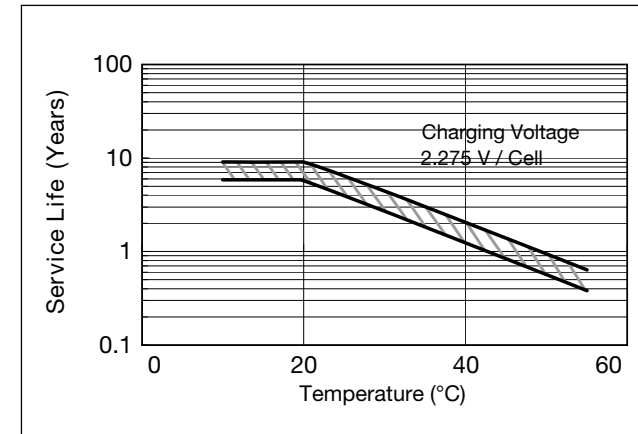

Cut off voltage

Discharge current	0.35A - 1.4A	1.4A - 3.5A	3.5A - 7A	7A - 14A	14A - 21A
Cut off voltage (V)	10.5	10.2	9.9	9.3	8.7

Residual capacity vs storage period

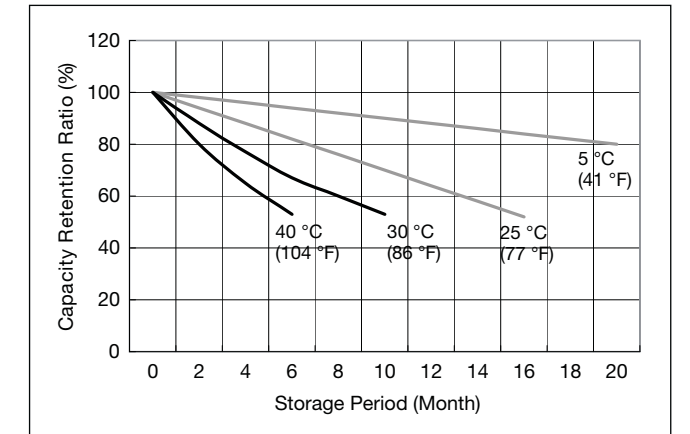

Constant-voltage and constant-current charge characteristics for Trickle use

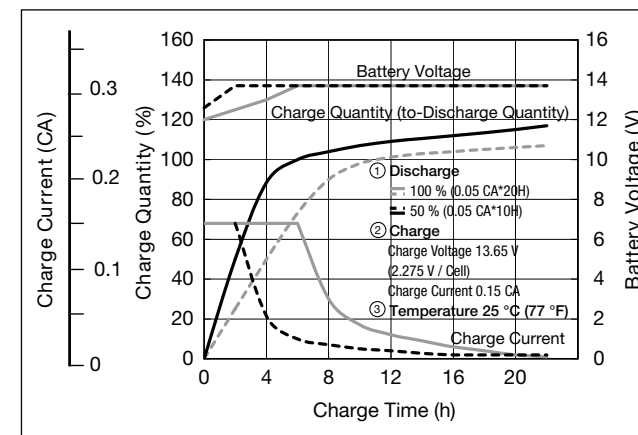

Discharge capacity by temperature and by discharge current

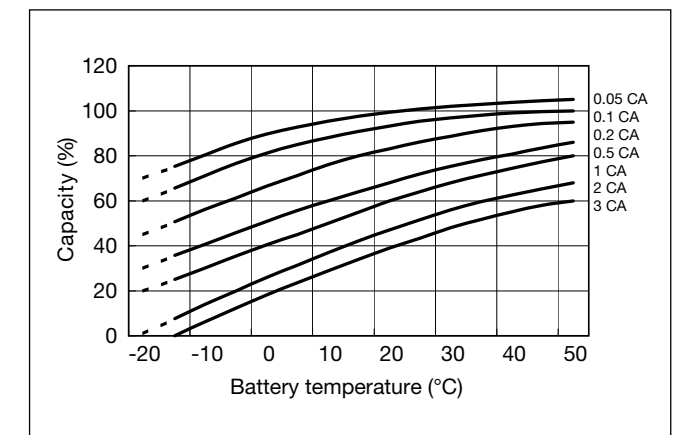

Discharge characteristics

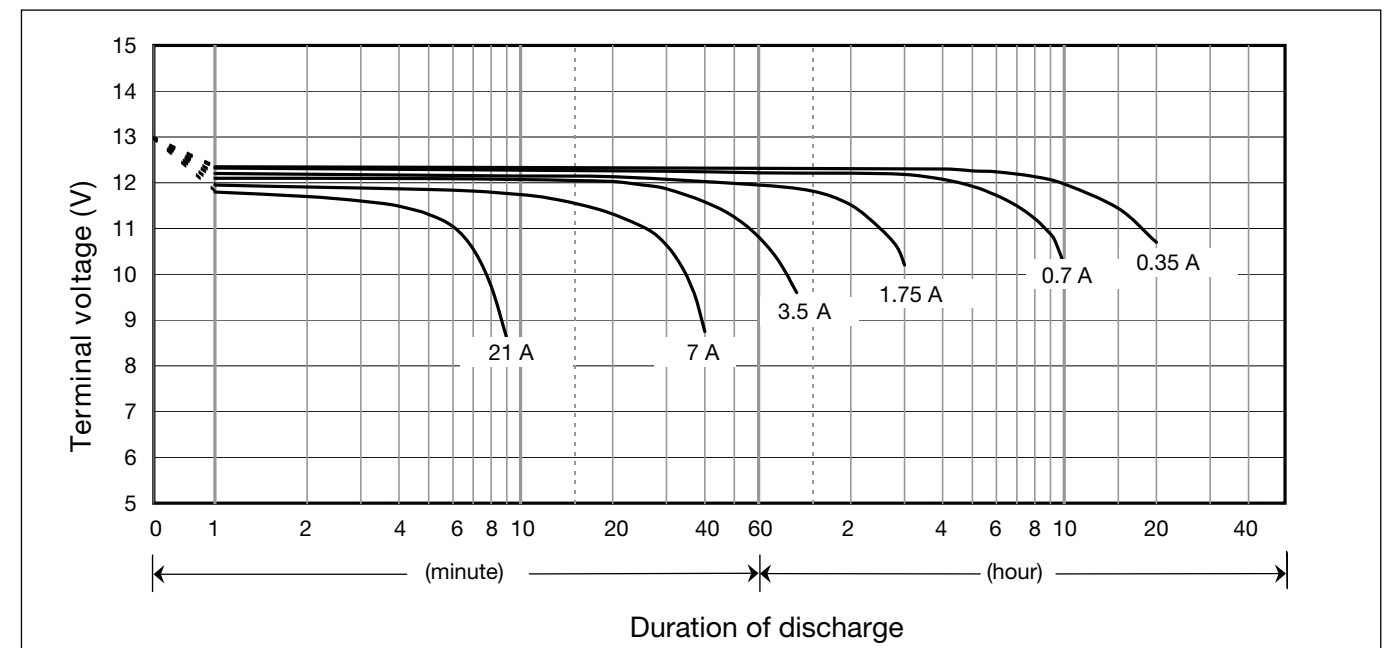

UP-RW1236P*1

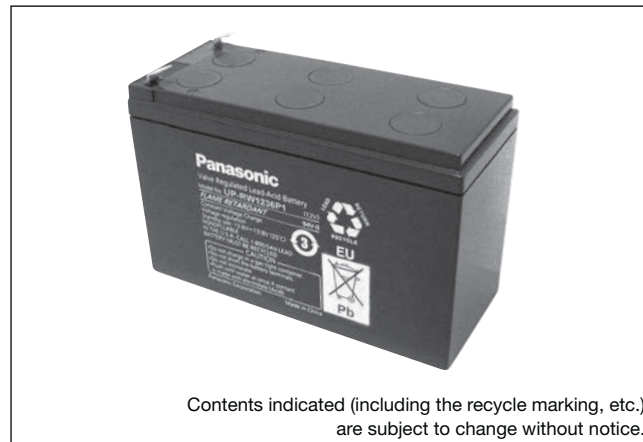

For standby power supplies.
Expected trickle design life: 6 – 9 years at 20°C according to Eurobat.

Dimensions (mm)

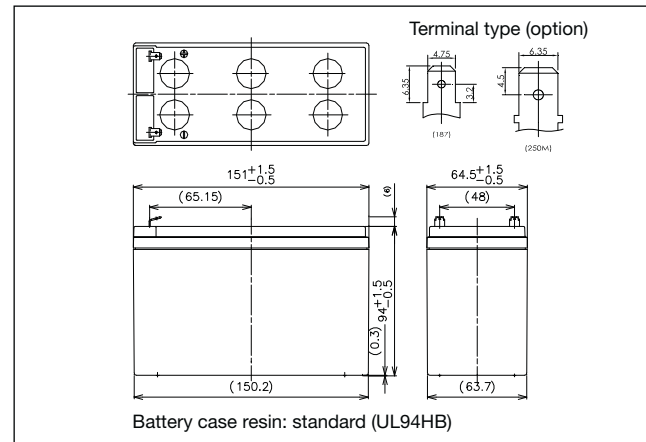

Specifications

Nominal voltage	12V	
Nominal capacity (10 minute rate)	192W	
Dimensions	Length	151mm
	Width	51mm
	Height	94mm
	Total Height	100mm
Approx. mass	2kg	
Terminal	Faston 250 with hole or Faston 187/250 mixed	

Duration of discharge vs Discharge current

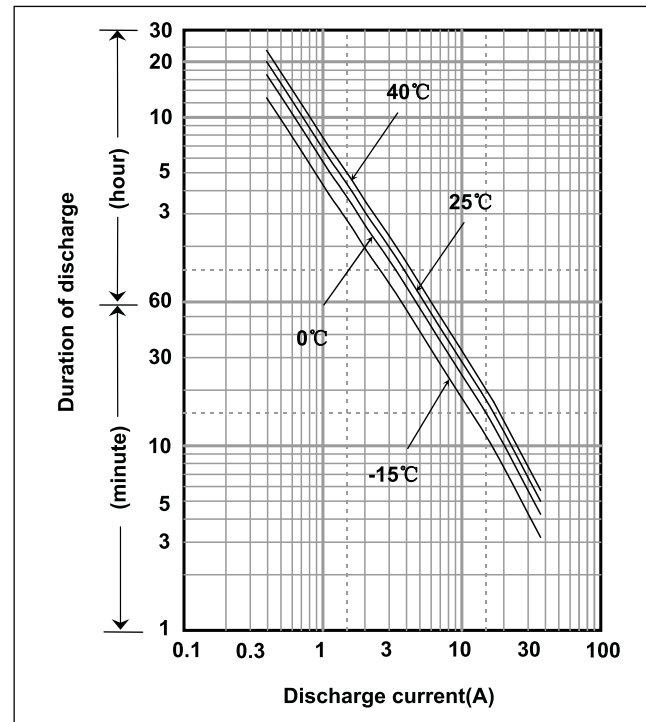

Characteristics

Capacity (25°C)	20 hour rate	97W
	10 hour rate	157W
	5 hour rate	192W
	1 hour rate	310W
Internal resistance	Fully charged battery (25°C)	33mΩ
Temperature dependency of capacity (20 hour rate)	40°C	102%
	25°C	100%
	0°C	85%
	-15°C	65%
Self discharge (25°C)	After 3 months	91%
	After 6 months	82%
	After 12 months	64%

Watt Table

Cut-off V	(Wattage/Battery)																	
	3min	5min	10min	15min	20min	30min	45min	1h	1.5h	2h	3h	4h	5h	6h	10h	20h	24h	
9.6V	461	348	224	169	140	102	73.3	58.3	44.1	34.5	24.3	18.6	15.1	12.7	7.60	4.02	3.33	
9.9V	434	298	190	161	135	99.5	72.8	56.9	43.3	34.2	24.2	18.4	15.0	12.4	7.56	4.01	3.32	
10.2V	406	283	185	153	131	97.4	69.8	55.3	41.0	32.3	23.1	18.1	14.4	12.1	7.24	3.87	3.20	
10.5V	368	258	177	146	125	93.7	67.9	54.1	39.4	31.3	22.6	17.7	14.3	12.0	7.21	3.86	3.19	
10.8V	331	232	167	140	120	90.1	63.6	50.0	36.8	27.9	21.0	16.4	13.1	11.1	6.72	3.61	2.98	

Ampere Table

Cut-off V	(Ampere/Battery)																	
	3min	5min	10min	15min	20min	30min	45min	1h	1.5h	2h	3h	4h	5h	6h	10h	20h	24h	
9.6V	38.1	28.7	17.7	14.1	11.4	8.57	6.26	4.99	3.42	2.64	1.96	1.50	1.23	0.990	0.655	0.355	0.296	
9.9V	35.9	27.4	17.3	13.4	11.0	8.39	6.22	4.85	3.35	2.62	1.95	1.49	1.22	0.986	0.652	0.354	0.295	
10.2V	33.5	26.0	16.8	12.8	10.7	8.21	5.96	4.73	3.18	2.48	1.86	1.43	1.17	0.946	0.624	0.342	0.285	
10.5V	30.4	23.7	16.0	12.2	10.2	7.91	5.80	4.63	3.05	2.40	1.82	1.37	1.10	0.936	0.622	0.330	0.284	
10.8V	27.3	21.3	15.1	11.7	9.80	7.60	5.43	4.28	2.85	2.14	1.69	1.32	1.07	0.866	0.579	0.319	0.265	

*1 This battery is also available with a flame retardant battery case resin (UL94 V-0).

Charging Method

Trickle use	Control voltage: 13.6 - 13.8V; Initial current: 0.93A or smaller
-------------	---

Cut off voltage

Discharge current	0.31A - 1.24A	1.24A - 3.1A	3.1A - 6.2A	6.2A - 12.4A	12.4A - 18.6A
Cut off voltage (V)	10.5	10.2	9.9	9.3	8.7

Influence of Temperature on Trickle life

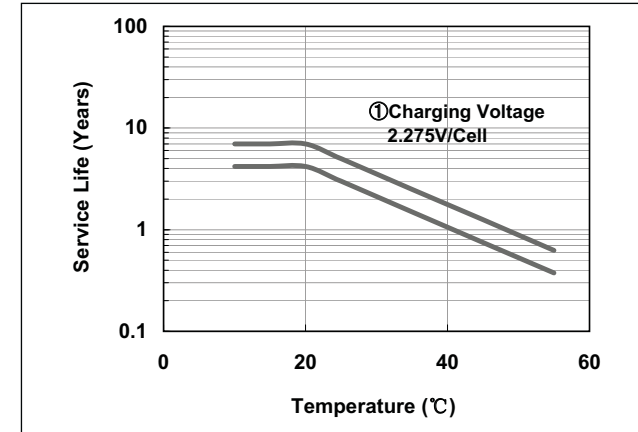

Residual capacity test result

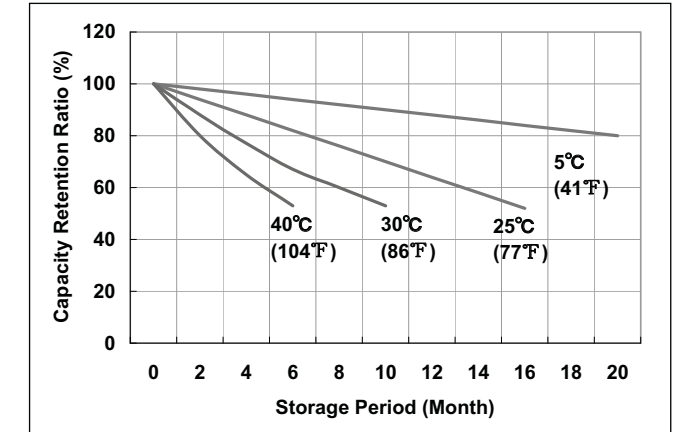

Constant-voltage and constant-current charge characteristics

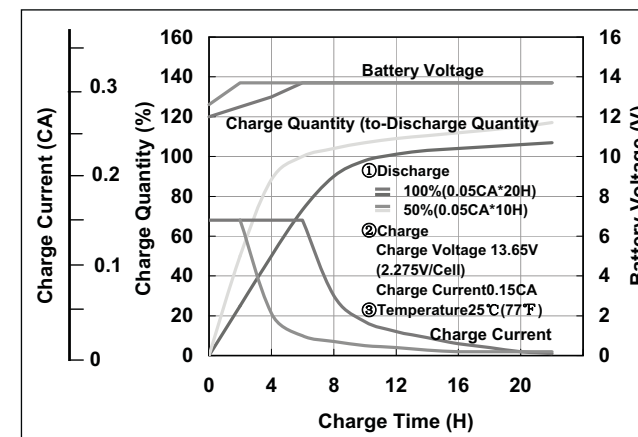

Discharge capacity by temperature and by discharge current

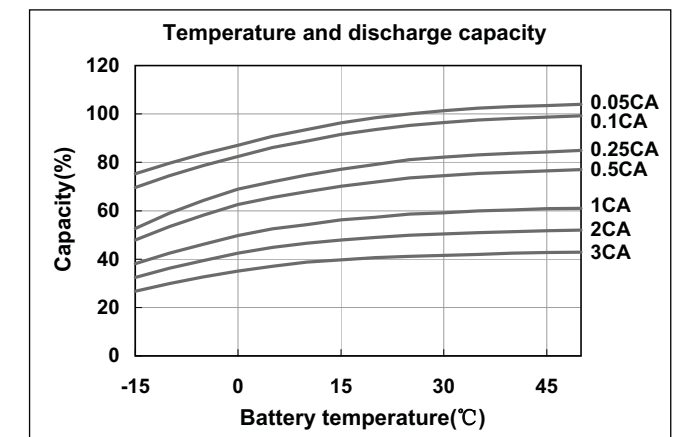

Discharge characteristics

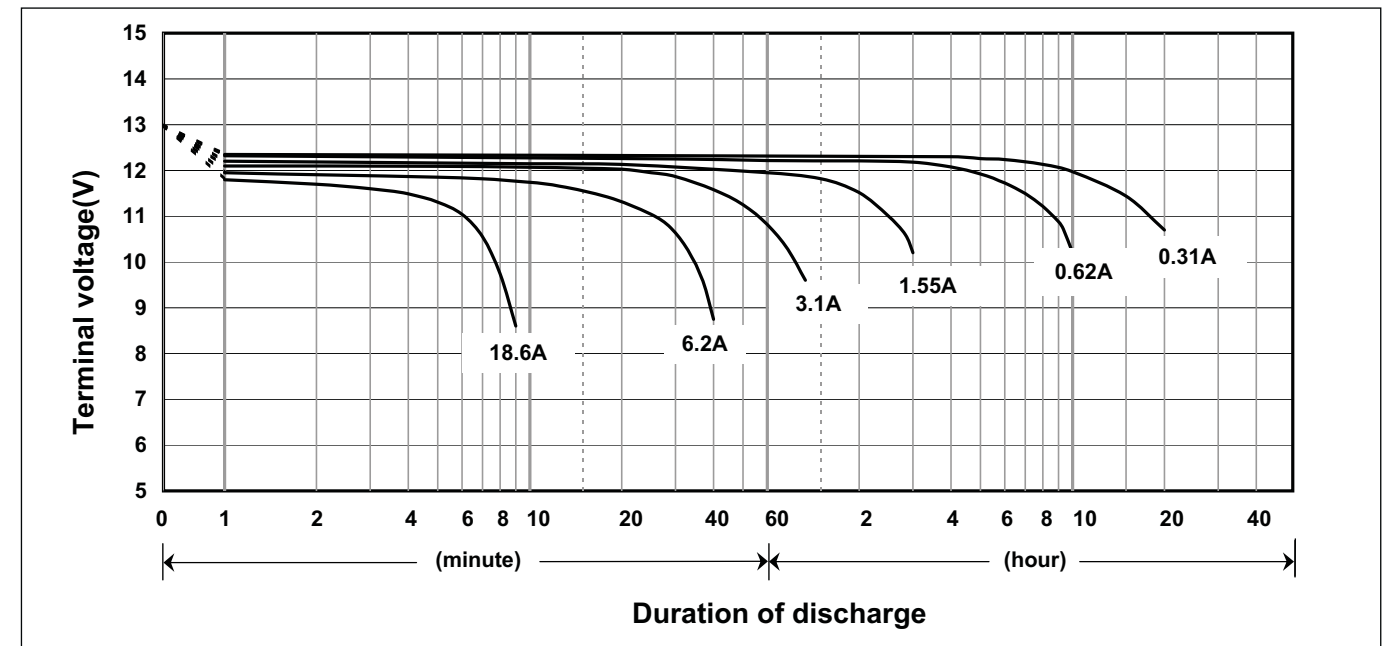

UP-RW1245P*1

For standby power supplies.
Expected trickle design life: 6 – 9 years at 20°C according to Eurobat.

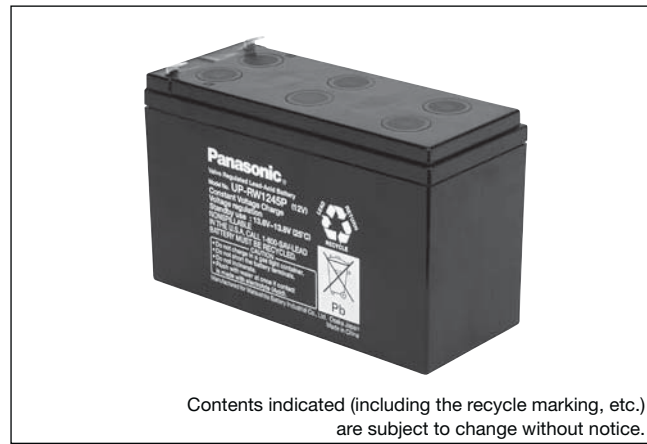

Dimensions (mm)

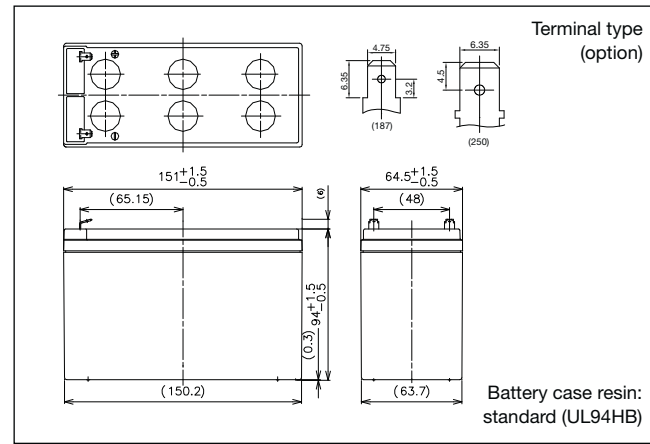

Specifications

Nominal voltage	12V	
Nominal capacity (10 minute rate)	270W	
Dimensions	Length	151mm
	Width	64.5mm
	Height	94mm
	Total Height	100mm
Approx. mass	2.6kg	
Terminal	Faston 187 or Faston 250 with hole	

Duration of discharge vs Discharge current

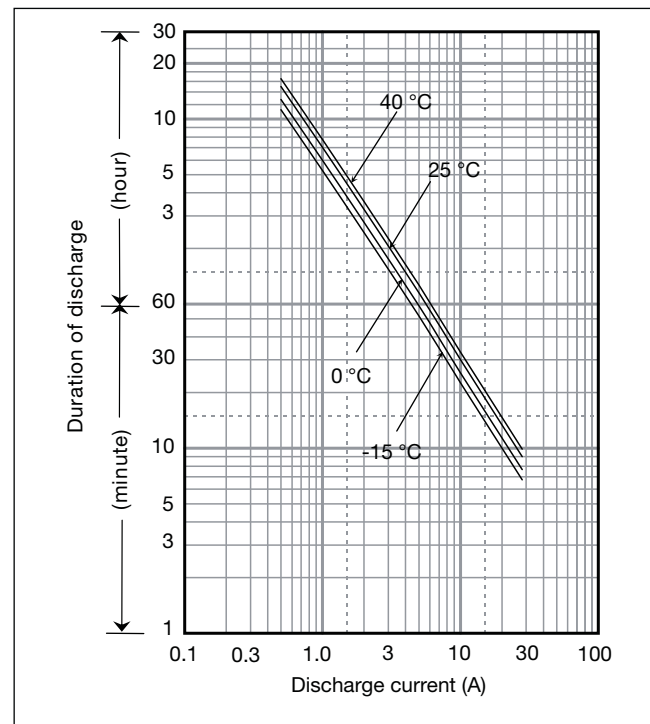

Characteristics

Capacity (25°C)	20 hour rate	112W
	10 hour rate	195W
	5 hour rate	268W
	1 hour rate	410W
Internal resistance	Fully charged battery (25°C)	20mΩ
Temperature dependency of capacity (20 hour rate)	40°C	102%
	25°C	100%
	0°C	85%
	-15°C	65%
Self discharge (25°C)	After 3 months	91%
	After 6 months	82%
	After 12 months	64%

Watt Table

Cut-off V	(Wattage/Battery)																
	3min	5min	10min	15min	20min	30min	45min	1h	1.5h	2h	3h	4h	5h	6h	10h	20h	24h
9.6V	530	410	268	195	159	112	82.1	65.7	45.2	34.9	26.0	20.0	16.5	13.3	8.79	4.76	3.97
9.9V	509	400	263	194	158	112	81.6	65.7	44.3	34.7	25.9	19.8	16.4	13.2	8.75	4.75	3.96
10.2V	490	390	258	193	156	111	80.8	64.4	43.4	33.9	25.6	19.7	16.2	13.1	8.65	4.73	3.95
10.5V	463	360	246	187	151	110	78.7	63.0	41.7	32.8	25.7	19.7	16.1	13.0	8.62	4.72	3.93
10.8V	434	330	234	180	146	109	78.3	61.8	41.3	31.1	24.7	19.3	15.7	12.7	8.52	4.69	3.91

Ampere Table

Cut-off V	(Ampere/Battery)																
	3min	5min	10min	15min	20min	30min	45min	1h	1.5h	2h	3h	4h	5h	6h	10h	20h	24h
9.6V	47.7	36.8	23.9	17.0	13.7	9.6	6.99	5.57	3.82	2.95	2.19	1.67	1.38	1.11	0.732	0.397	0.331
9.9V	45.8	35.9	23.5	16.9	13.6	9.6	6.95	5.57	3.75	2.93	2.17	1.66	1.37	1.10	0.729	0.396	0.330
10.2V	44.1	35.0	23.0	16.8	13.5	9.5	6.88	5.46	3.67	2.86	2.15	1.65	1.36	1.09	0.721	0.394	0.329
10.5V	41.6	32.3	22.0	16.3	13.0	9.4	6.70	5.35	3.53	2.77	2.16	1.65	1.35	1.08	0.718	0.393	0.328
10.8V	39.0	29.6	20.9	15.7	12.6	9.3	6.67	5.25	3.50	2.62	2.08	1.62	1.31	1.06	0.710	0.391	0.326

*1 This battery is also available with a flame retardant battery case resin (UL94 V-0).

Charging Method

Trickle use	Control voltage: 13.6 - 13.8V; Initial current: 1.2A or smaller
-------------	---

Influence of Temperature on Trickle life

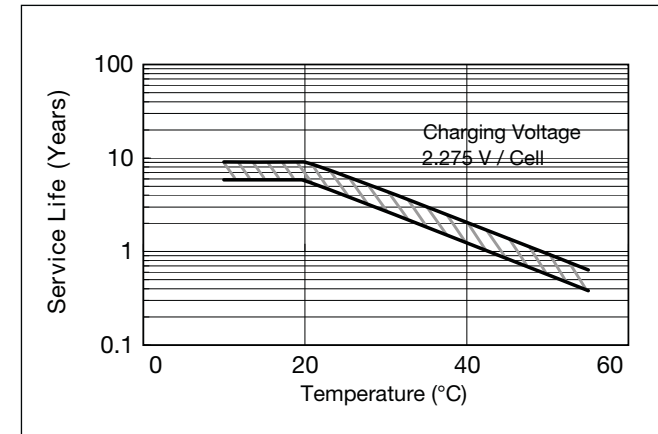

Cut off voltage

Discharge current	0.4A - 1.6A	1.6A - 4A	4A - 8A	8A - 16A	16A - 24A
Cut off voltage (V)	10.5	10.2	9.9	9.3	8.7

Residual capacity vs storage period

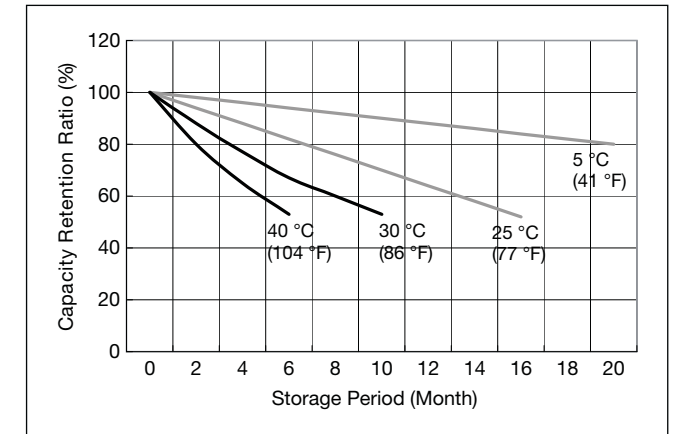

Constant-voltage and constant-current charge characteristics for Trickle use

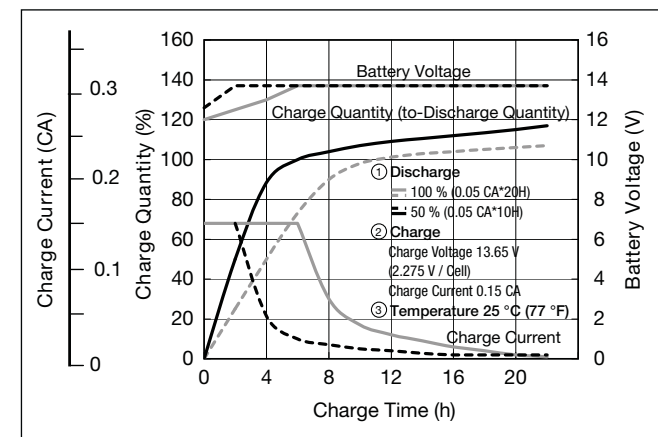

Discharge capacity by temperature and by discharge current

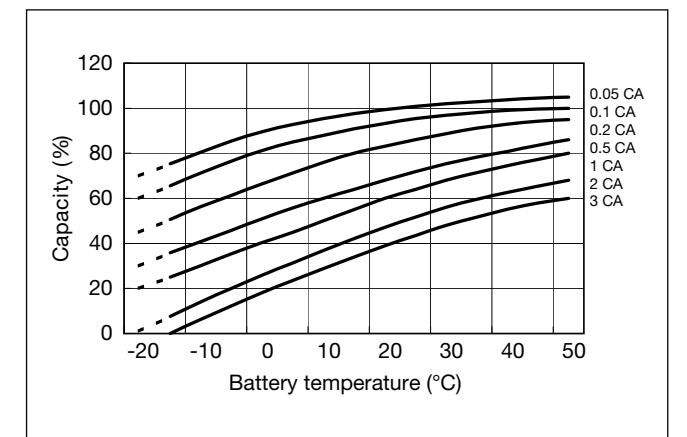

Discharge characteristics

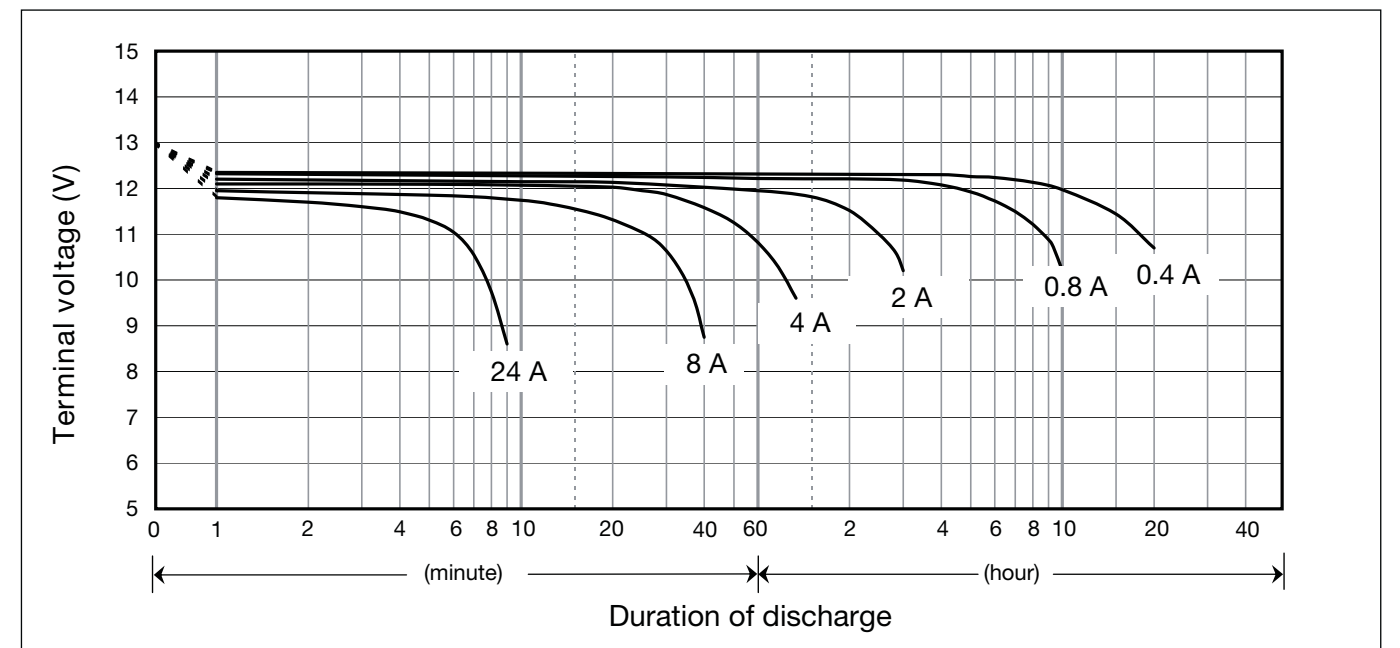

UP-PW1245P



For standby power supplies.
Expected trickle design life: 10 – 12 years at 20°C according to Eurobat.

Dimensions (mm)

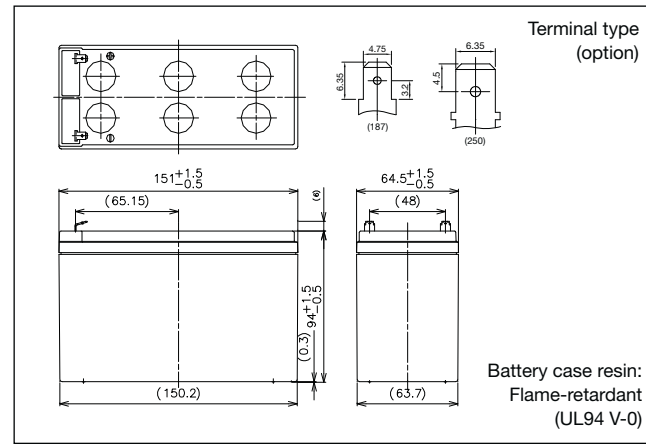

Specifications

Nominal voltage	12V	
Nominal capacity (10 minute rate)	270W	
Dimensions	Length	151mm
	Width	64.5mm
	Height	94mm
	Total Height	100mm
Approx. mass	2.6kg	
Terminal	Faston 187 or Faston 250 with hole	

Characteristics

Capacity (25°C)	20 hour rate	112W
	10 hour rate	195W
	5 hour rate	268W
	1 hour rate	410W
Internal resistance	Fully charged battery (25°C)	20mΩ
Temperature dependency of capacity (20 hour rate)	40°C	102%
	25°C	100%
	0°C	85%
	-15°C	65%
Self discharge (25°C)	After 3 months	91%
	After 6 months	82%
	After 12 months	64%

Duration of discharge vs Discharge current

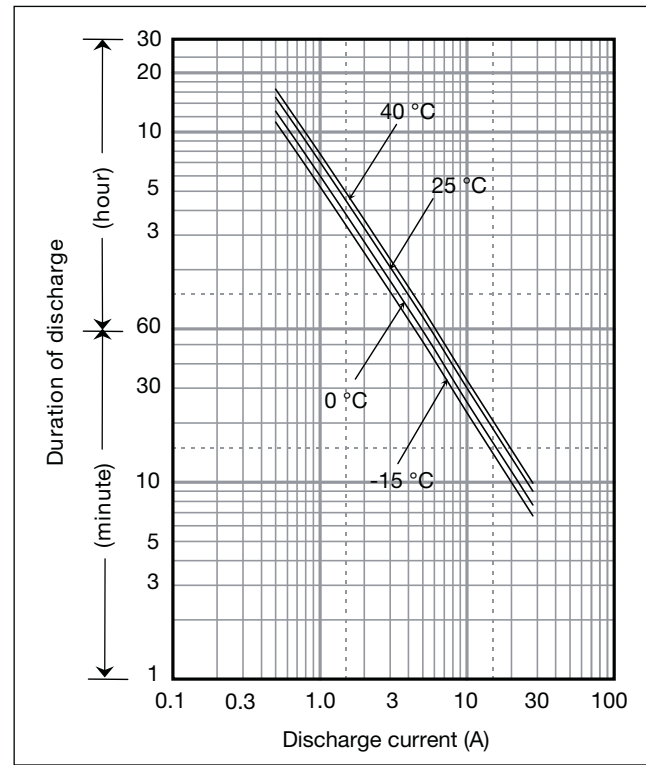

Watt Table

Cut-off V	(Wattage/Battery)																	
	3min	5min	10min	15min	20min	30min	45min	1h	1.5h	2h	3h	4h	5h	6h	10h	20h	24h	
9.6V	530	410	268	195	159	112	82.1	65.7	45.2	34.9	26.0	20.0	16.5	13.3	8.79	4.76	3.97	
9.9V	509	400	263	194	158	112	81.6	65.7	44.3	34.7	25.9	19.8	16.4	13.2	8.75	4.75	3.96	
10.2V	490	390	258	193	156	111	80.8	64.4	43.4	33.9	25.6	19.7	16.2	13.1	8.65	4.73	3.95	
10.5V	463	360	246	187	151	110	78.7	63.0	41.7	32.8	25.7	19.7	16.1	13.0	8.62	4.72	3.93	
10.8V	434	330	234	180	146	109	78.3	61.8	41.3	31.1	24.7	19.3	15.7	12.7	8.52	4.69	3.91	

Ampere Table

Cut-off V	(Ampere/Battery)																	
	3min	5min	10min	15min	20min	30min	45min	1h	1.5h	2h	3h	4h	5h	6h	10h	20h	24h	
9.6V	47.7	36.8	23.9	17.0	13.7	9.57	6.99	5.57	3.82	2.95	2.19	1.67	1.38	1.11	0.732	0.397	0.331	
9.9V	45.8	35.9	23.5	16.9	13.6	9.55	6.95	5.57	3.75	2.93	2.17	1.66	1.37	1.10	0.729	0.396	0.330	
10.2V	44.1	35.0	23.0	16.8	13.5	9.49	6.88	5.46	3.67	2.86	2.15	1.65	1.36	1.09	0.721	0.394	0.329	
10.5V	41.6	32.3	22.0	16.3	13.0	9.40	6.70	5.35	3.53	2.77	2.16	1.65	1.35	1.08	0.718	0.393	0.328	
10.8V	39.0	29.6	20.9	15.7	12.6	9.32	6.67	5.25	3.50	2.62	2.08	1.62	1.31	1.06	0.710	0.391	0.326	

Charging Method

Trickle use	Control voltage: 13.6 - 13.8V; Initial current: 1.2A or smaller
-------------	---

Influence of Temperature on Trickle life

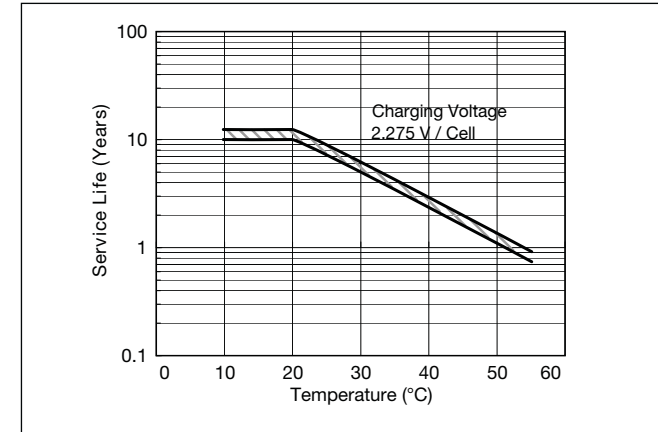

Cut off voltage

Discharge current	0.4A - 1.6A	1.6A - 4A	4A - 8A	8A - 16A	16A - 24A
Cut off voltage (V)	10.5	10.2	9.9	9.3	8.7

Residual capacity vs storage period

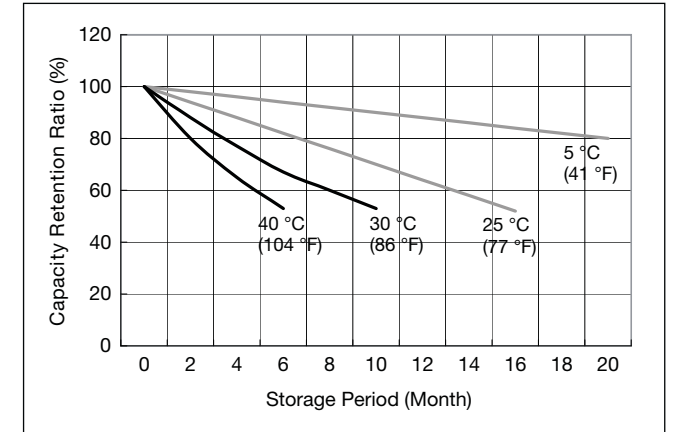

Constant-voltage and constant-current charge characteristics for Trickle use

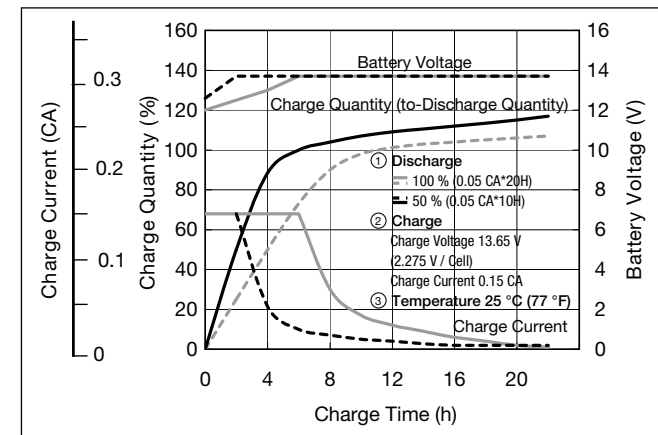

Discharge capacity by temperature and by discharge current

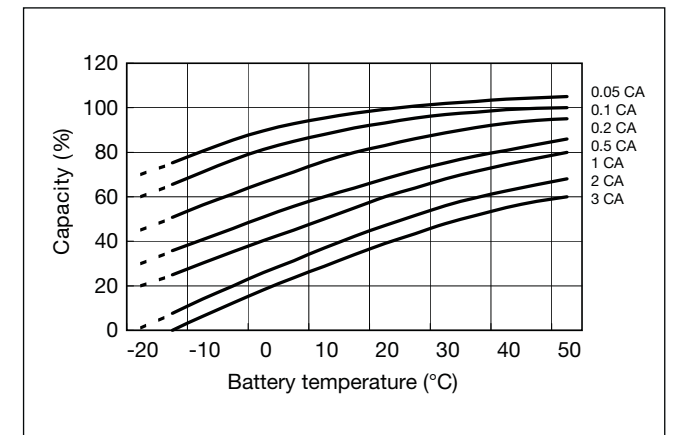

Discharge characteristics

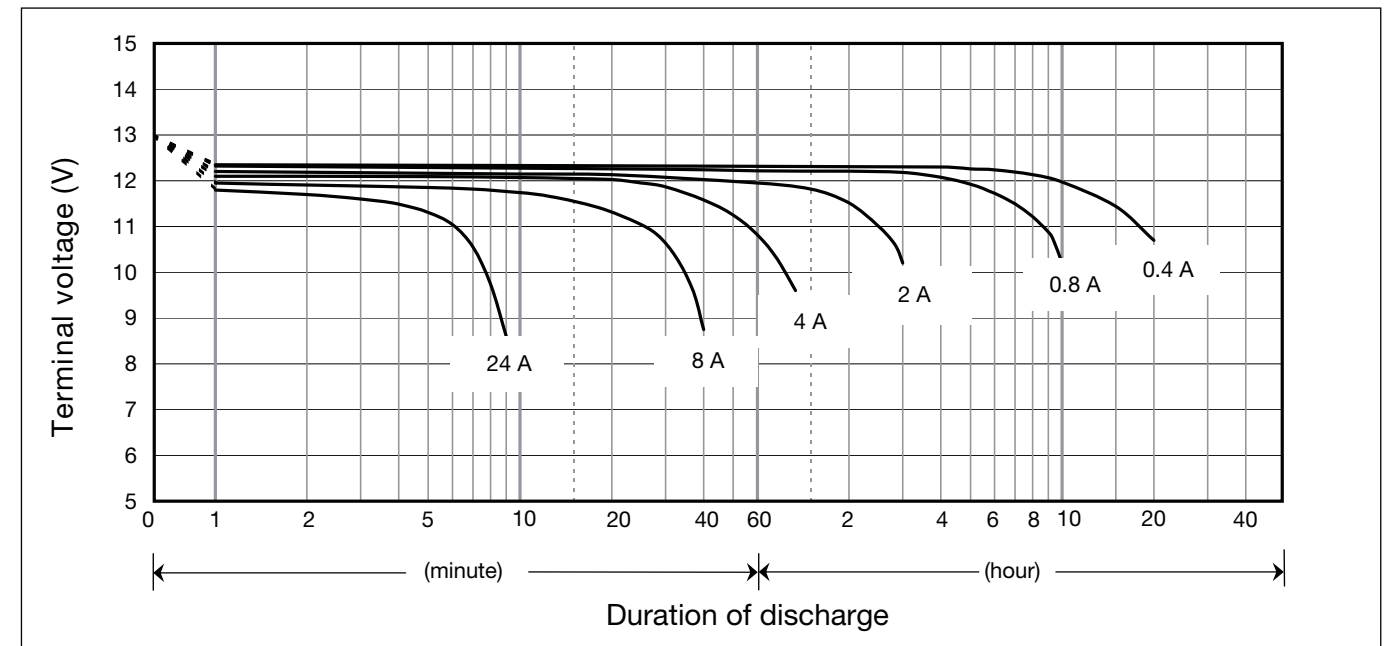

LC-QA06210TP



For standby power supplies.
Expected trickle design life: 15 years at 20°C according to Eurobat.

Dimensions (mm)

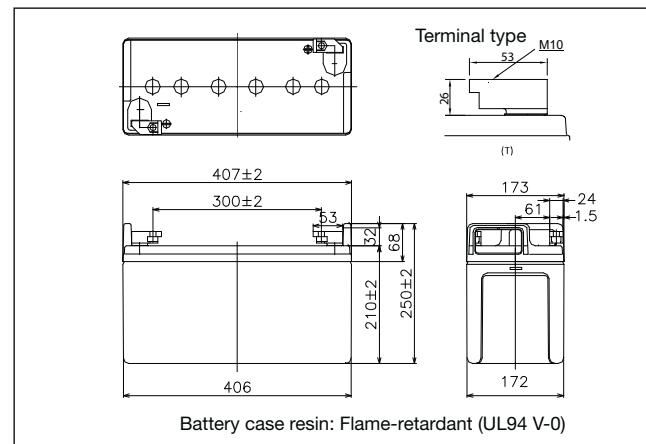

Specifications

Nominal voltage	6V	
Nominal capacity (20 hour rate)	210Ah	
Dimensions	Length	407mm
	Width	173mm
	Height	210mm
	Total Height	250mm
Approx. mass	36.5kg	
Terminal	M10 Bolt and Nut type	

Duration of discharge vs Discharge current

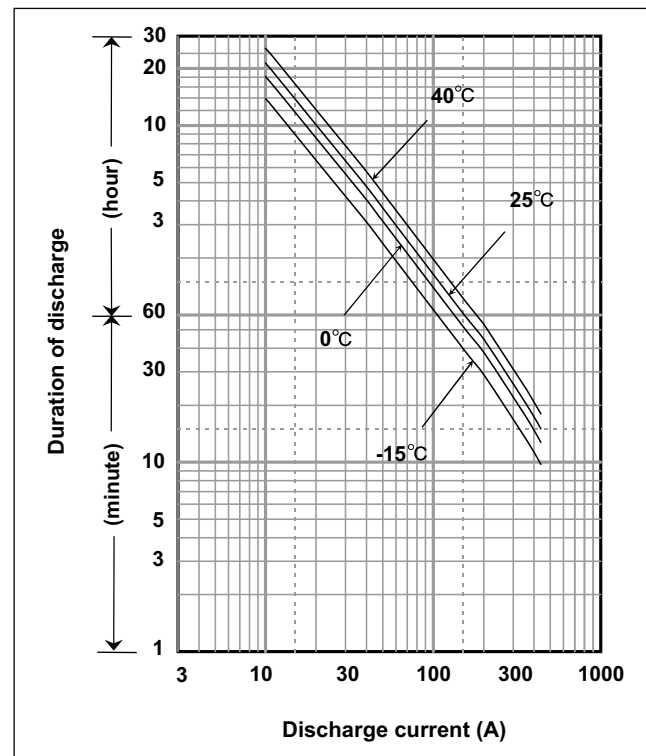

Characteristics

Capacity (25°C)	20 hour rate 10 hour rate 5 hour rate 1 hour rate	210Ah 200Ah 190Ah 150Ah
Internal resistance	Fully charged battery (25°C)	1.5mΩ
Temperature dependency of capacity (20 hour rate)	40°C 25°C 0°C -15°C	102% 100% 85% 65%
Self discharge (25°C)	After 3 months After 6 months After 12 months	91% 82% 64%

Watt Table

Cut-off V	(Wattage/Battery)													
	15min	20min	30min	45min	1h	1.5h	2h	3h	4h	5h	6h	10h	20h	24h
4.8V	2220	1816	1349	986	769	561	467	343	274	222	191	121	61.8	52.3
4.95V	2167	1773	1317	964	749	546	454	337	268	215	185	117	61.8	52.3
5.1V	2089	1709	1274	954	729	531	448	331	262	209	180	115	61.1	51.7
5.25V	2063	1696	1264	939	708	517	439	325	260	209	180	114	61.1	51.7
5.4V	1966	1687	1223	905	698	509	428	319	254	203	177	113	59.8	50.6

Ampere Table

Cut-off V	(Ampere/Battery)													
	15min	20min	30min	45min	1h	1.5h	2h	3h	4h	5h	6h	10h	20h	24h
4.8V	440	364	274	200	153	107	88.1	61.5	47.6	39.5	32.3	20.5	10.6	9.12
4.95V	438	362	272	195	153	105	87.5	60.4	47.1	38.8	32.3	20.5	10.6	9.12
5.1V	436	358	268	193	152	104	86.4	60.0	46.7	38.2	32.1	20.3	10.6	9.12
5.25V	412	341	263	191	151	103	85.4	60.0	46.7	38.2	32.1	20.3	10.6	9.12
5.4V	398	333	259	165	131	92.3	81.1	57.3	45.6	37.8	31.0	20.1	10.4	9.12

Charging Method

Trickle Use	Control voltage: 6.80 - 6.90V; Initial current: 31.5A or smaller
-------------	---

Cut off voltage

Discharge current	10.5A - 42A	42A - 105A	105A - 210A	210A - 420A
Cut off voltage (V)	5.25	5.1	4.95	4.65

Influence of Temperature on Trickle life

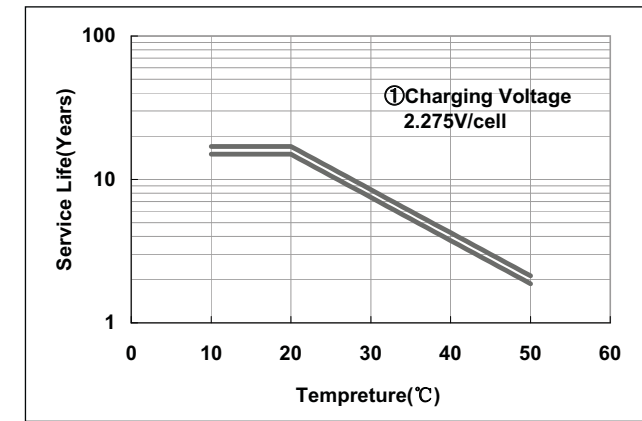

Residual capacity test result

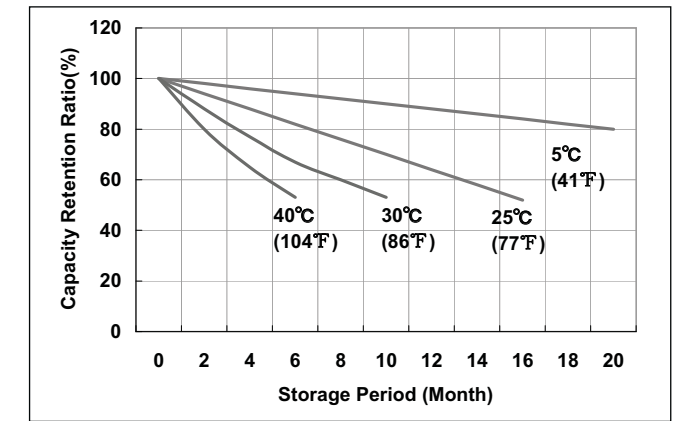

Constant-voltage and constant-current charge characteristics

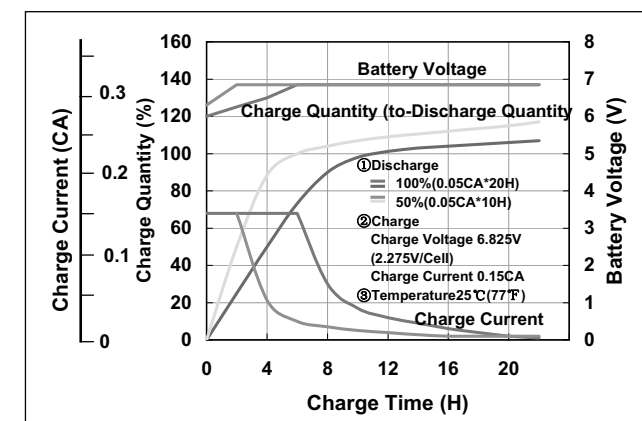

Discharge capacity by temperature and by discharge current

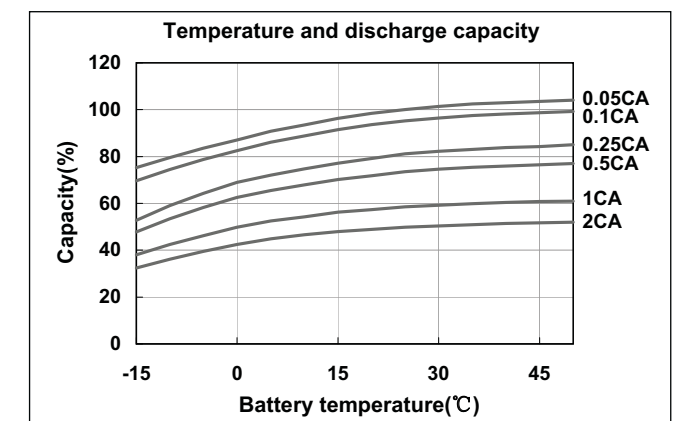

Discharge characteristics

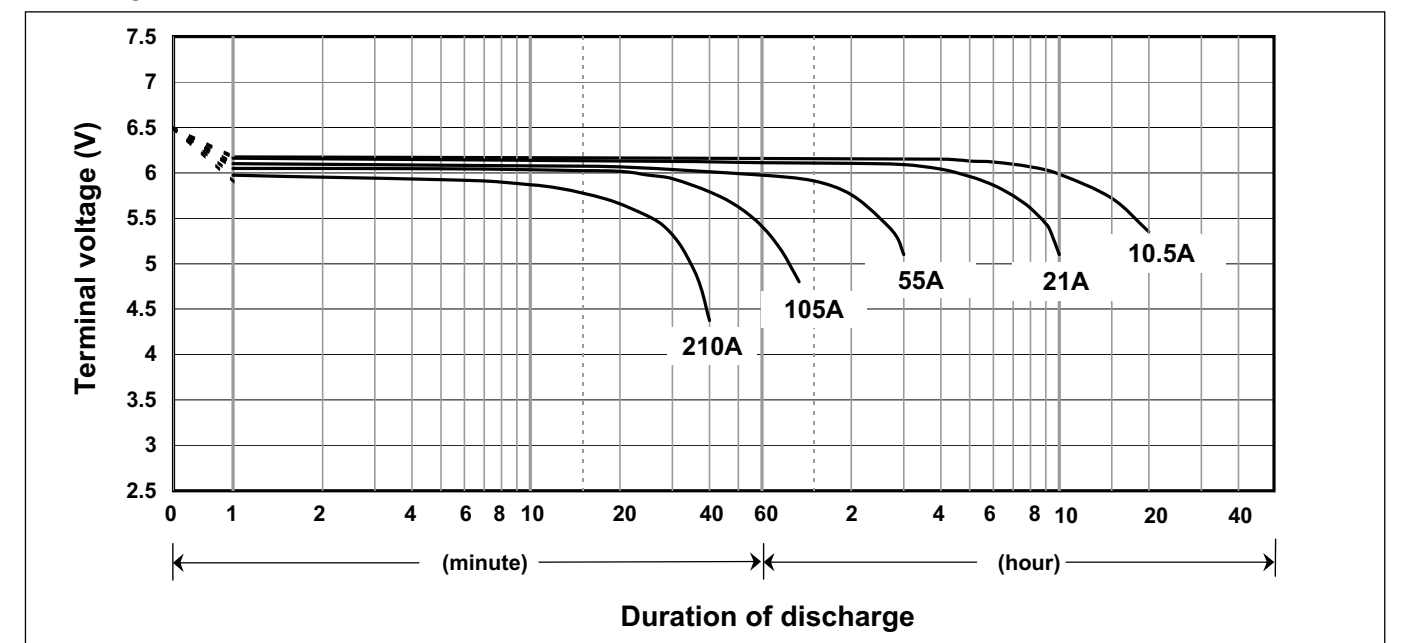

LC-QA1224AP

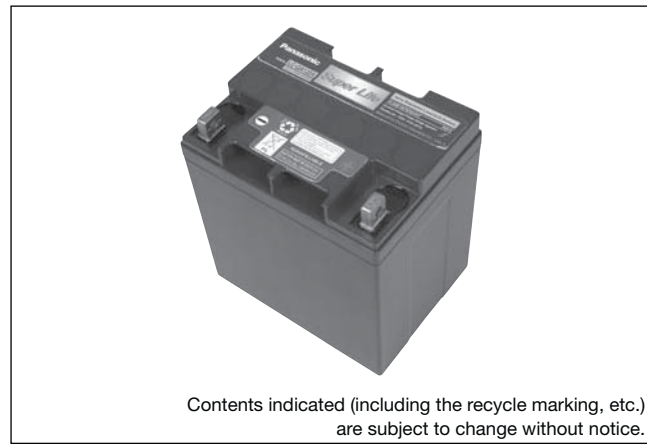

For standby power supplies.
Expected trickle design life: 15 years at 20°C according to Eurobat.

Dimensions (mm)

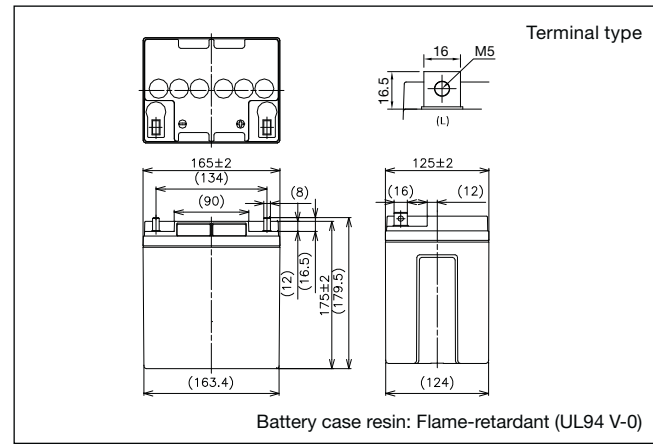

Specifications

Nominal voltage	12V	
Nominal capacity (20 hour rate)	24Ah	
Dimensions	Length	165mm
	Width	125mm
	Height	175mm
	Total Height	175mm
Approx. mass	10kg	
Terminal	M5 Bolt and Nut type	

Characteristics

Capacity (25°C)	20 hour rate 10 hour rate 5 hour rate 1 hour rate	24Ah 22Ah 19Ah 14Ah
Internal resistance	Fully charged battery (25°C)	8mΩ
Temperature dependency of capacity (20 hour rate)	40°C	102%
	25°C	100%
	0°C	85%
	-15°C	65%
Self discharge (25°C)	After 3 months	91%
	After 6 months	82%
	After 12 months	64%

Duration of discharge vs Discharge current

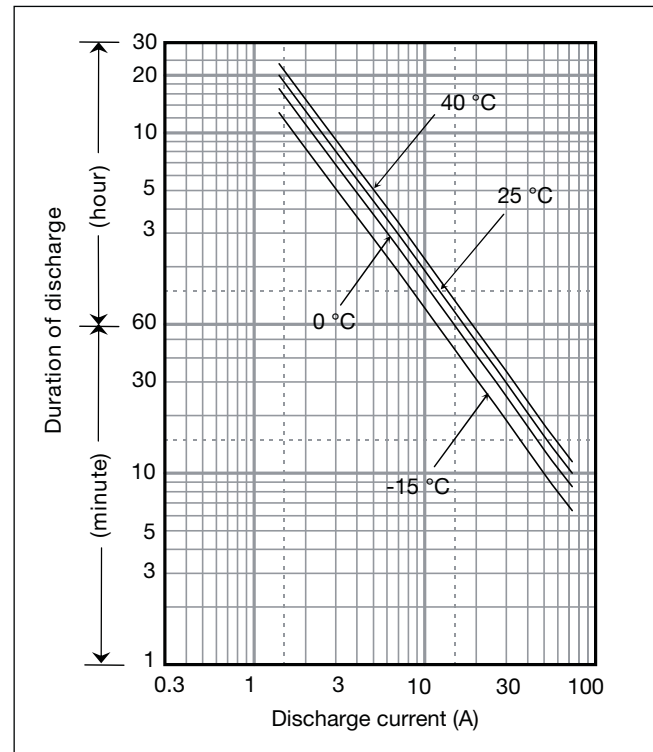

Watt Table

Cut-off V	(Wattage/Battery)														
	10min	15min	20min	30min	45min	1h	1.5h	2h	3h	4h	5h	6h	10h	20h	24h
9.6V	773	605	521	401	280	215	167	113	79.9	65.8	51.8	46.8	27.0	13.5	11.5
9.9V	760	600	512	396	274	210	163	113	79.7	65.3	50.9	46.0	26.8	13.5	11.5
10.2V	746	591	503	390	268	205	159	111	79.3	64.7	50.1	45.3	26.4	13.4	11.5
10.5V	724	575	479	372	261	200	155	107	78.2	64.0	49.7	44.8	26.1	13.3	11.5
10.8V	701	558	456	344	256	196	152	104	77.1	63.2	49.5	44.3	25.9	13.3	11.5

Ampere Table

Cut-off V	(Ampere/Battery)														
	10min	15min	20min	30min	45min	1h	1.5h	2h	3h	4h	5h	6h	10h	20h	24h
9.6V	72.6	51.2	42.8	30.5	22.4	17.4	11.3	9.90	6.98	5.51	4.50	3.83	2.48	1.35	1.13
9.9V	70.3	50.1	42.3	30.3	21.8	17.0	11.1	9.79	6.86	5.40	4.39	3.71	2.48	1.35	1.13
10.2V	67.7	49.2	41.3	30.0	21.4	16.7	11.1	9.68	6.75	5.40	4.28	3.71	2.48	1.35	1.13
10.5V	64.9	47.3	39.5	29.3	20.3	15.8	11.0	9.56	6.64	5.29	4.28	3.71	2.48	1.35	1.13
10.8V	63.8	46.4	38.8	28.2	18.0	13.8	10.3	9.00	6.41	5.18	4.28	3.60	2.48	1.35	1.13

Charging Method

Trickle Use	Control voltage 13.6 - 13.8V; Initial current 3.6A or smaller
-------------	---

Cut off voltage

Discharge current	1.2A - 4.8A	4.8A - 12A	12A - 24A	24A - 48A	48A - 72A
Cut off voltage (V)	10.5	10.2	9.9	9.3	8.7

Influence of Temperature on Trickle life

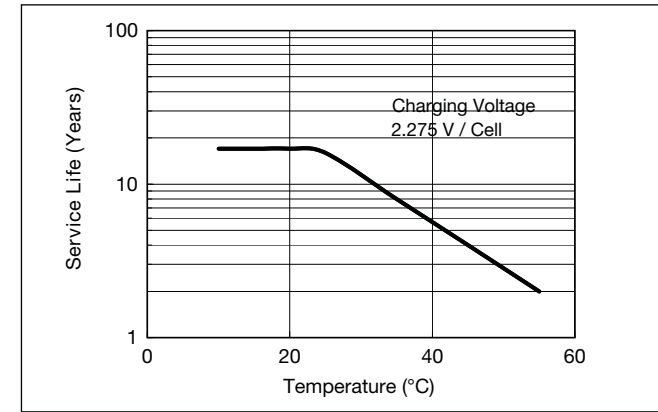

Residual capacity vs storage period

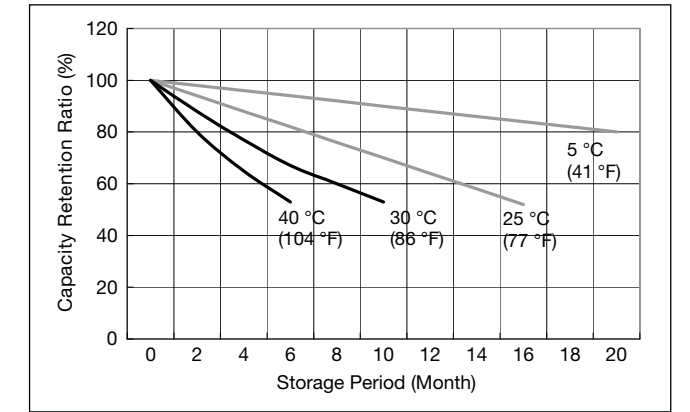

Constant-voltage and constant-current charge characteristics for Trickle use

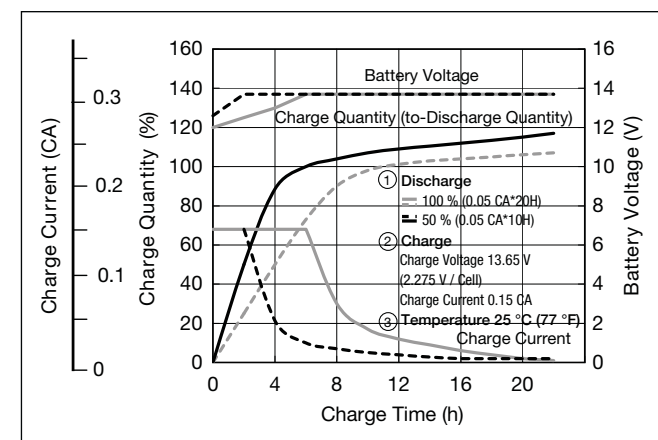

Discharge capacity by temperature and by discharge current

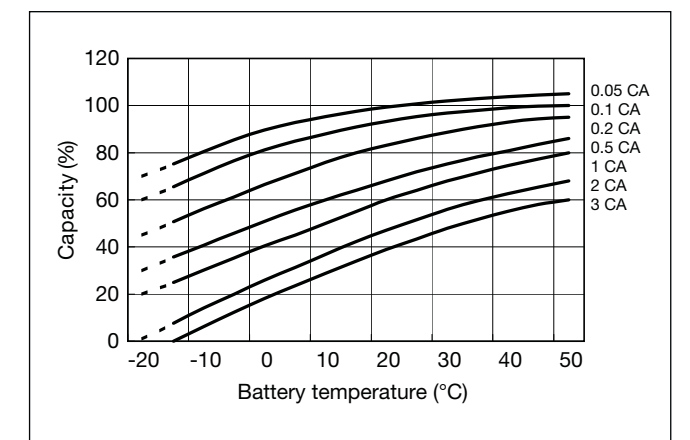

Discharge characteristics

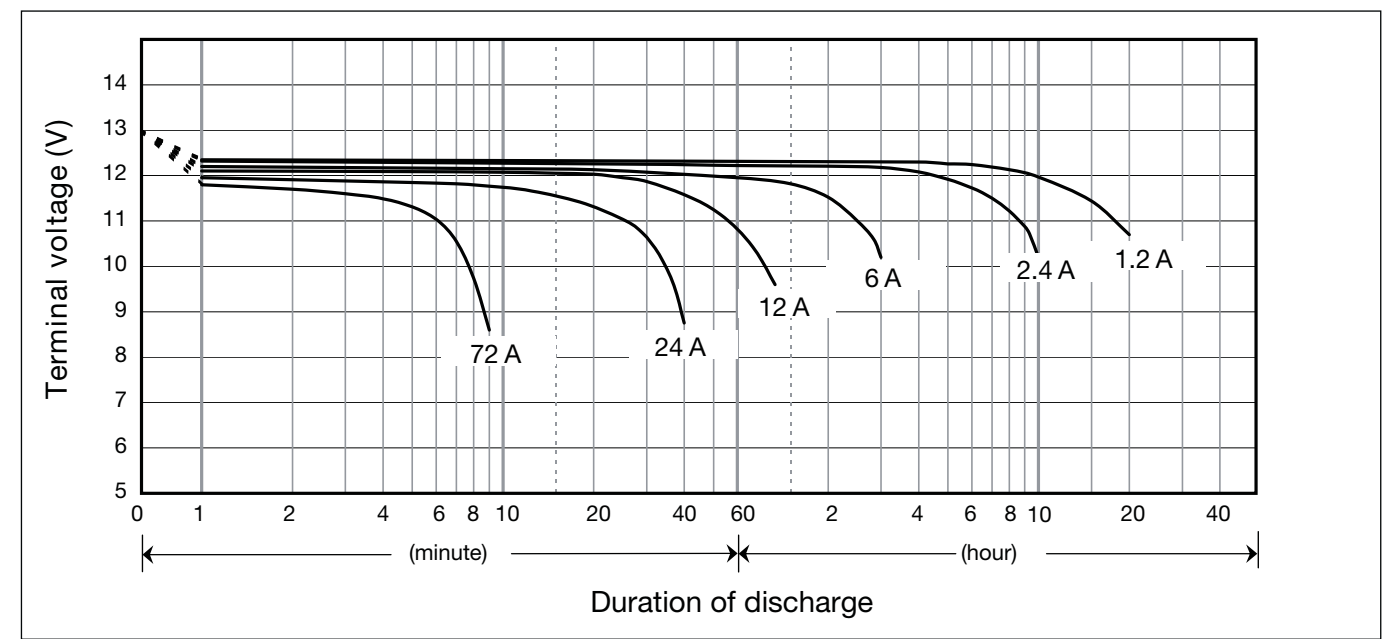

LC-QA1242P/AP

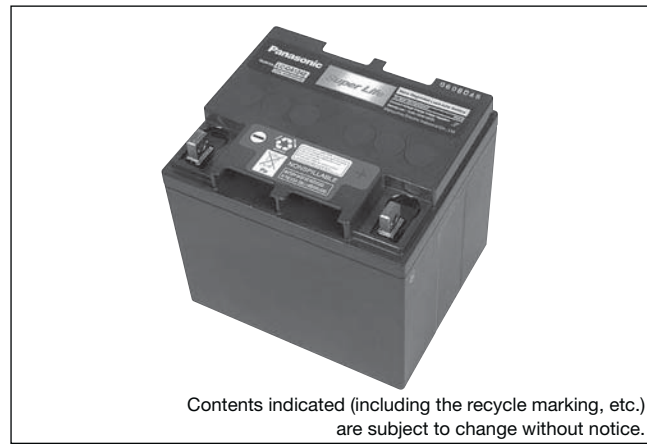

For standby power supplies.
Expected trickle design life: 15 years at 20°C according to Eurobat.

Dimensions (mm)

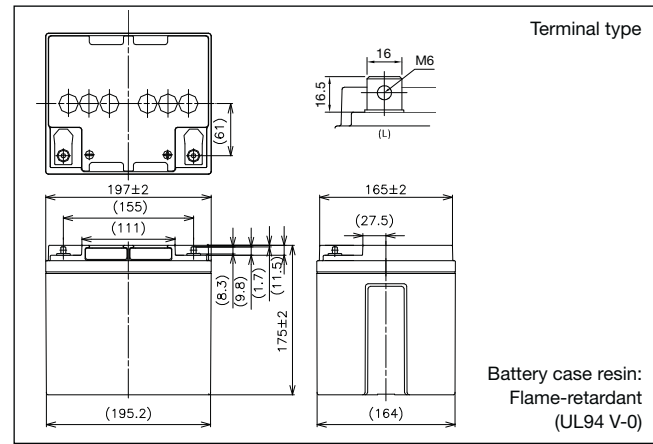

Specifications

Nominal voltage	12V	
Nominal capacity (20 hour rate)	42Ah	
Dimensions	Length	197mm
	Width	165mm
	Height	175mm
	Total Height	180mm
Approx. mass	16kg	
Terminal	M6 Bolt and Nut type	

Duration of discharge vs Discharge current

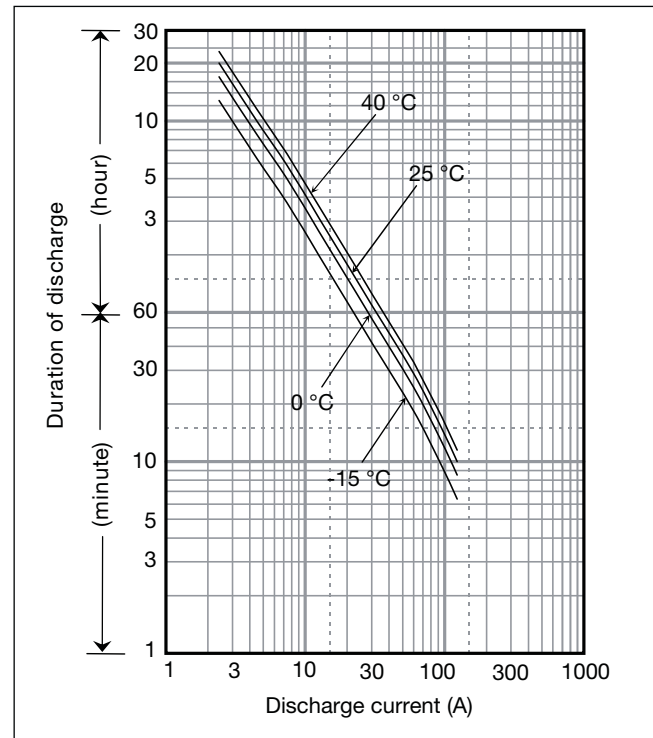

Characteristics

Capacity (25°C)	20 hour rate	42Ah
	10 hour rate	40Ah
	5 hour rate	37Ah
	1 hour rate	26Ah
Internal resistance	Fully charged battery (25°C)	8mΩ
Temperature dependency of capacity (20 hour rate)	40°C	102%
	25°C	100%
	0°C	85%
	-15°C	65%
Self discharge (25°C)	After 3 months	91%
	After 6 months	82%
	After 12 months	64%

Watt Table

Cut-off V	(Wattage/Battery)														
	10min	15min	20min	30min	45min	1h	1.5h	2h	3h	4h	5h	6h	10h	20h	24h
9.6V	1202	1015	862	655	486	393	284	230	156	128	100	90.1	49.2	25.1	20.7
9.9V	1146	951	829	630	476	387	279	224	152	124	98.4	88.5	48.4	25.1	20.7
10.2V	1087	887	775	606	465	382	276	214	148	123	97.1	87.2	48.0	25.1	20.7
10.5V	1072	866	743	575	453	363	262	210	145	119	92.9	83.3	44.9	24.0	20.7
10.8V	1077	844	720	546	444	355	256	203	142	116	89.8	80.6	43.8	22.4	20.7

Ampere Table

Cut-off V	(Ampere/Battery)														
	10min	15min	20min	30min	45min	1h	1.5h	2h	3h	4h	5h	6h	10h	20h	24h
9.6V	123	94.5	81.0	60.1	39.3	29.8	23.0	17.8	12.5	10.4	8.44	7.43	4.50	2.36	1.97
9.9V	121	94.5	79.9	58.4	39.0	29.6	22.3	17.7	12.3	10.2	8.33	7.43	4.50	2.36	1.97
10.2V	119	92.3	78.8	57.3	38.9	29.4	20.7	17.4	12.0	10.1	8.33	7.31	4.50	2.36	1.97
10.5V	116	90.0	77.6	56.3	38.8	29.3	20.1	17.4	11.9	10.1	8.33	7.31	4.50	2.36	1.97
10.8V	107	86.6	75.4	55.1	37.4	28.1	19.1	16.4	11.5	9.9	8.21	7.09	4.50	2.36	1.95

Charging Method

Trickle Use	Control voltage 13.6 - 13.8V; Initial current 6.3A or smaller
-------------	---

Cut off voltage

Discharge current	2.1A - 8.4A	8.4A - 21A	21A - 42A	42A - 84A	84A - 126A
Cut off voltage (V)	10.5	10.2	9.9	9.3	8.7

Influence of Temperature on Trickle life

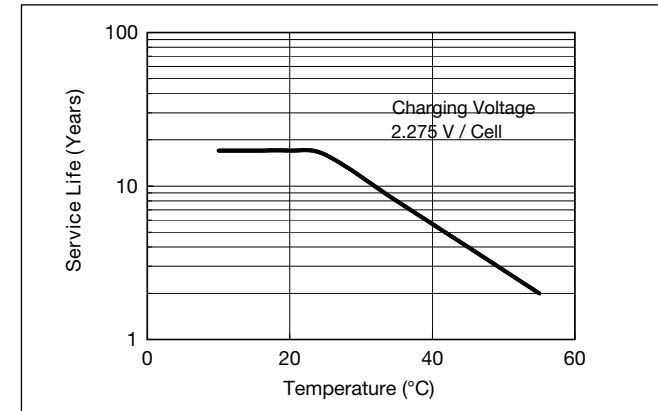

Residual capacity vs storage period

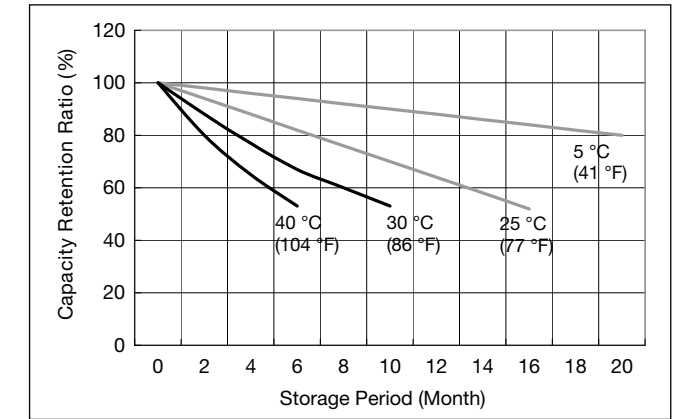

Constant-voltage and constant-current charge characteristics for Trickle use

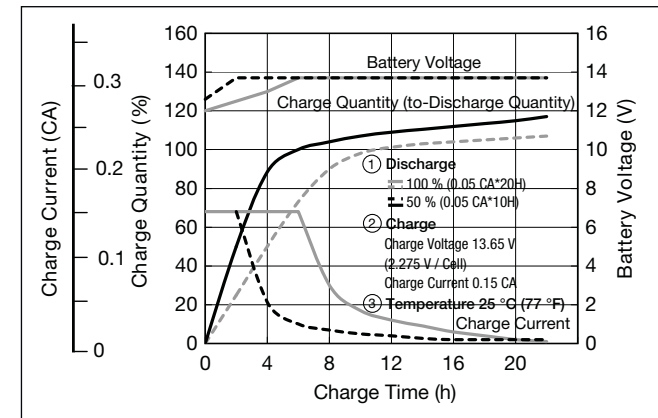

Discharge capacity by temperature and by discharge current

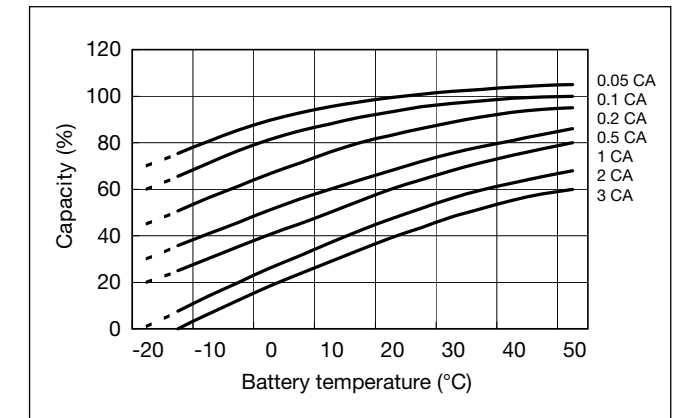

Discharge characteristics

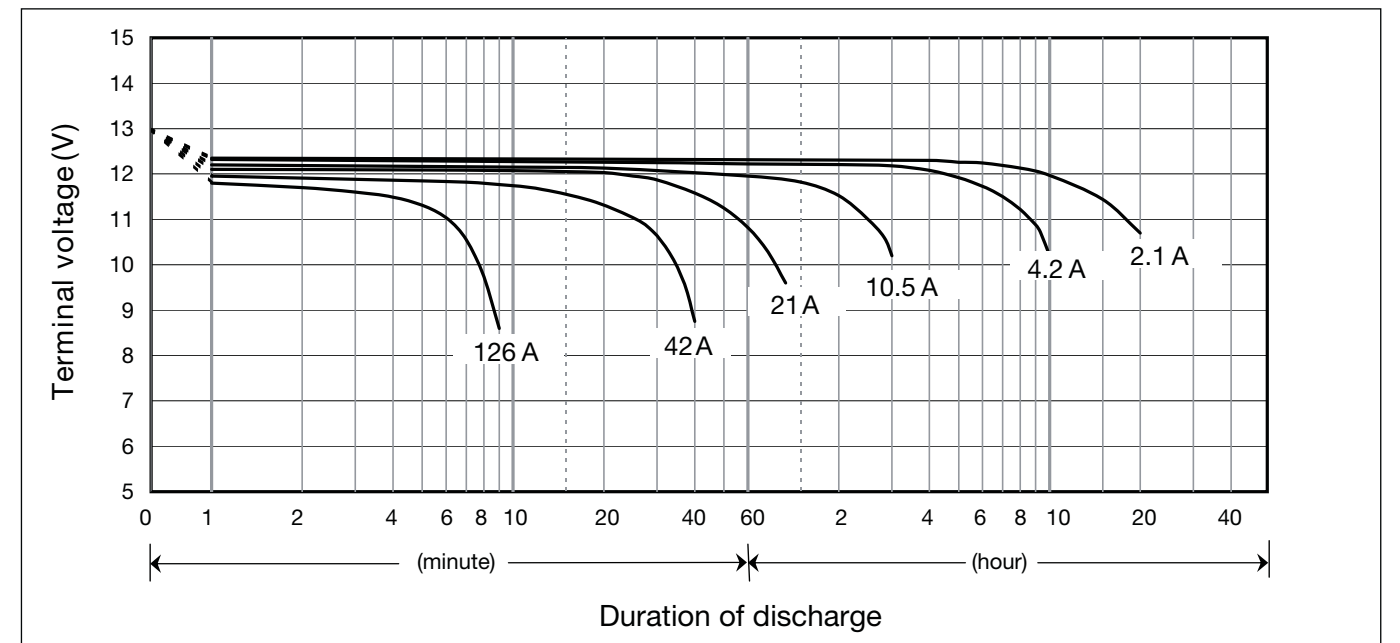

LC-QA1270P

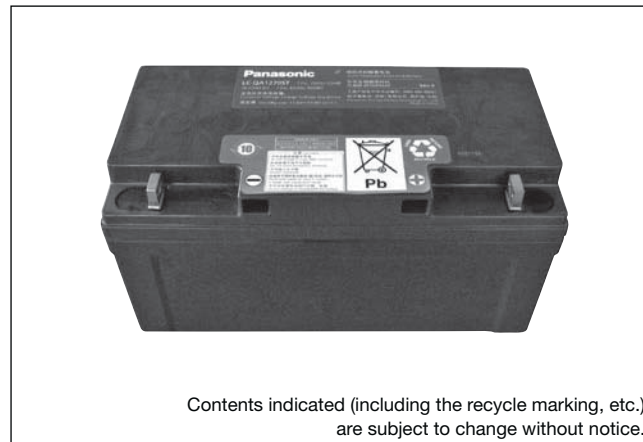

Contents indicated (including the recycle marking, etc.) are subject to change without notice.

For standby power supplies.
Expected trickle design life: 15 years at 20°C according to Eurobat.

Dimensions (mm)

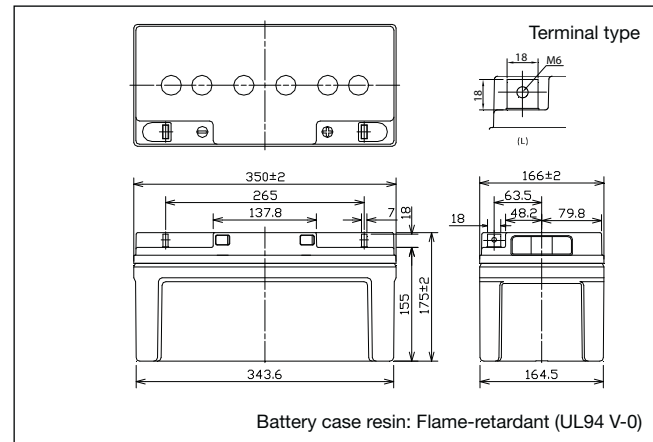

Specifications

Nominal voltage	12V	
Nominal capacity (20 hour rate)	70Ah	
Dimensions	Length	350mm
	Width	166mm
	Height	175mm
	Total Height	175mm
Approx. mass	23.5kg	
Terminal	M6 Bolt and Nut type	

Duration of discharge vs Discharge current

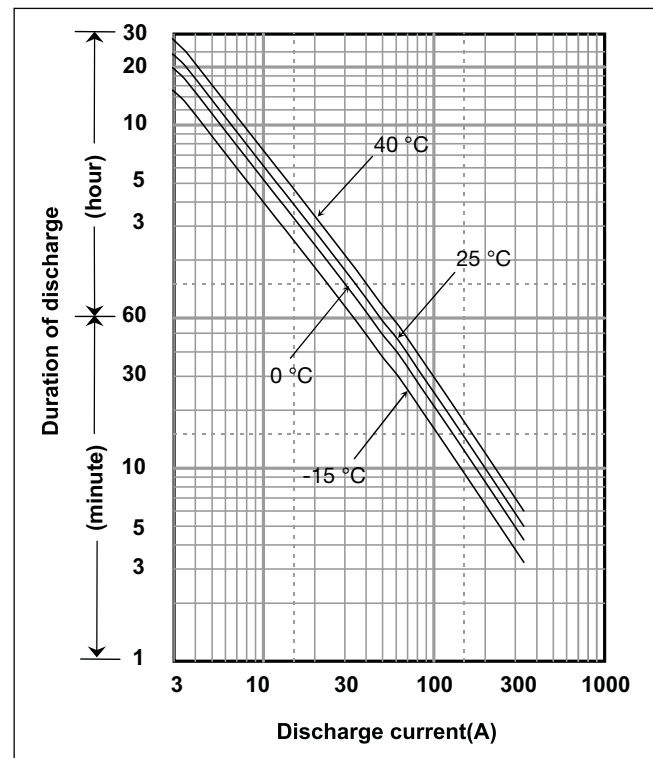

Characteristics

Capacity (25°C)	20 hour rate 10 hour rate 5 hour rate 1 hour rate	70Ah 65Ah 60Ah 45Ah
Internal resistance	Fully charged battery (25°C)	5mΩ
Temperature dependency of capacity (20 hour rate)	40°C 25°C 0°C -15°C	102% 100% 85% 65%
Self discharge (25°C)	After 3 months After 6 months After 12 months	91% 82% 64%

Watt Table

Cut-off V	(Wattage/Battery)														
	10min	15min	20min	30min	45min	1h	1.5h	2h	3h	4h	5h	6h	10h	20h	24h
9.6V	1977	1504	1234	916	676	549	386	333	240	181	148	130	75.5	41.7	34.7
9.9V	1947	1491	1227	909	660	520	367	323	234	177	146	127	74.0	41.5	34.7
10.2V	1867	1463	1197	899	655	519	365	311	224	168	138	122	73.1	41.2	34.3
10.5V	1814	1436	1173	884	641	509	358	306	221	166	135	119	73.0	39.8	33.8
10.8V	1704	1357	1153	865	626	499	351	299	219	165	135	119	73.0	39.4	33.6

Ampere Table

Cut-off V	(Ampere/Battery)														
	10min	15min	20min	30min	45min	1h	1.5h	2h	3h	4h	5h	6h	10h	20h	24h
9.6V	200	146	118	85.9	62.8	48.4	34.8	27.1	19.4	15.0	12.5	10.4	6.50	3.53	2.94
9.9V	199	144	118	85.0	61.2	47.7	33.9	27.0	19.1	14.8	12.1	10.4	6.50	3.53	2.94
10.2V	197	146	116	83.8	60.9	47.3	33.7	26.8	18.9	14.8	12.1	10.3	6.50	3.53	2.94
10.5V	187	136	110	82.7	59.5	45.6	33.3	26.7	18.9	14.7	12.1	10.3	6.50	3.53	2.94
10.8V	177	132	108	81.4	51.1	41.0	29.4	24.9	17.8	14.4	12.0	10.1	6.50	3.47	2.94

Charging Method

Trickle Use	Control voltage: 13.6 - 13.8V; Initial current: 10.5A or smaller
-------------	---

Cut off voltage

Discharge current	3.5A - 14A	14A - 35A	35A - 70A	70A - 140A	140A - 210A
Cut off voltage (V)	10.5	10.2	9.9	9.3	8.7

Influence of Temperature on Trickle life

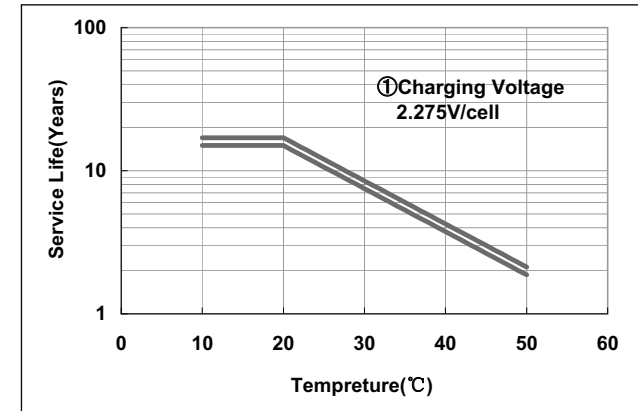

Residual capacity test result

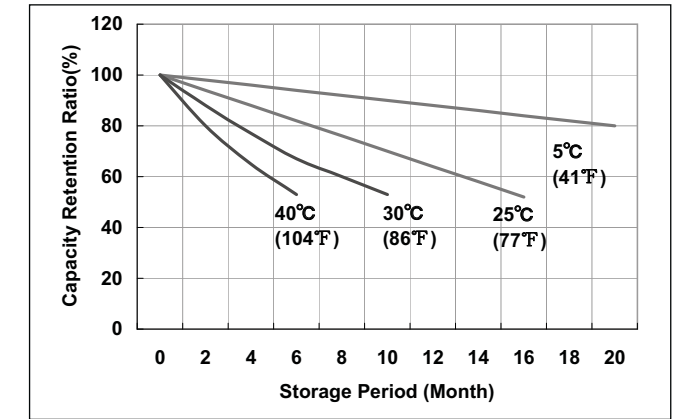

Constant-voltage and constant-current charge characteristics

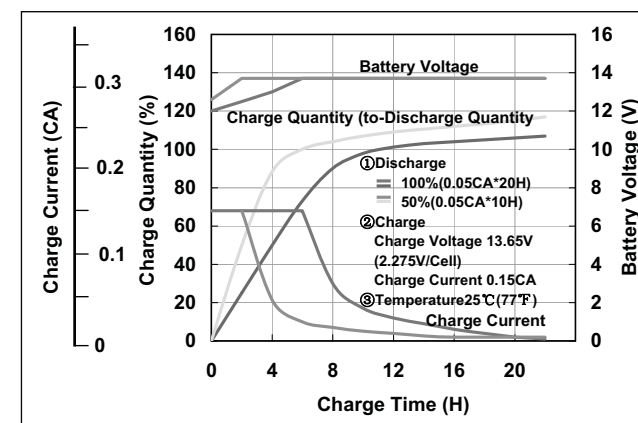

Discharge capacity by temperature and by discharge current

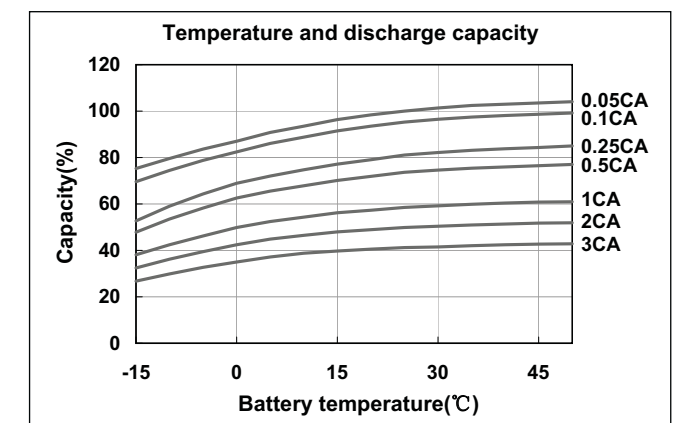

Discharge characteristics

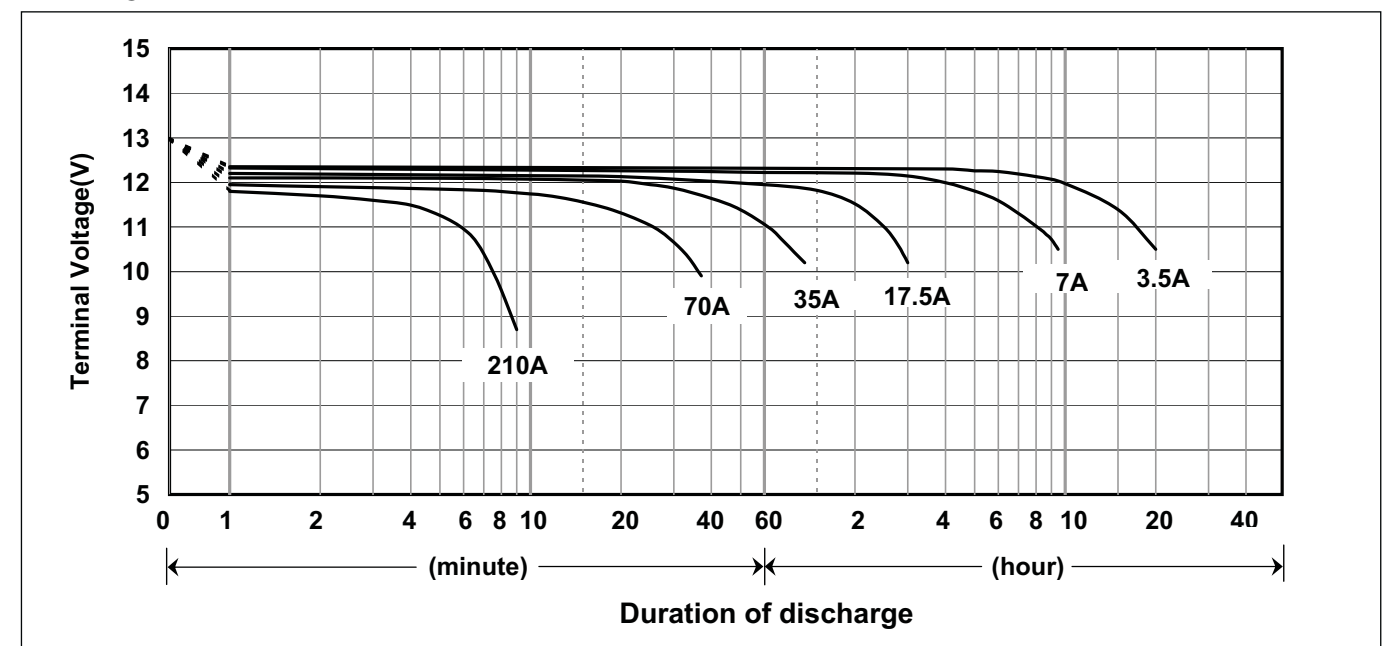

LC-QA12110TP



For standby power supplies.
Expected trickle design life: 15 years at 20°C according to Eurobat.

Dimensions (mm)

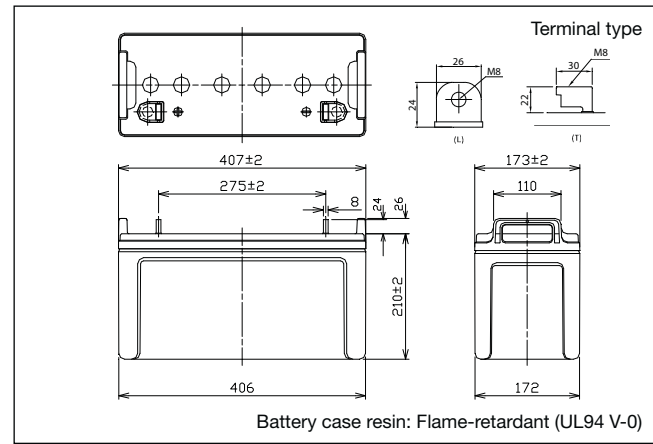

Specifications

Nominal voltage	12V	
Nominal capacity (20 hour rate)	110Ah	
Dimensions	Length	407mm
	Width	173mm
	Height	210mm
	Total Height	236mm
Approx. mass	36kg	
Terminal	M8 Bolt and Nut type	

Characteristics

Capacity (25°C)	20 hour rate 10 hour rate 5 hour rate 1 hour rate	110Ah 100Ah 95Ah 75Ah
Internal resistance	Fully charged battery (25°C)	4mΩ
Temperature dependency of capacity (20 hour rate)	40°C 25°C 0°C -15°C	102% 100% 85% 65%
Self discharge (25°C)	After 3 months After 6 months After 12 months	91% 82% 64%

Duration of discharge vs Discharge current

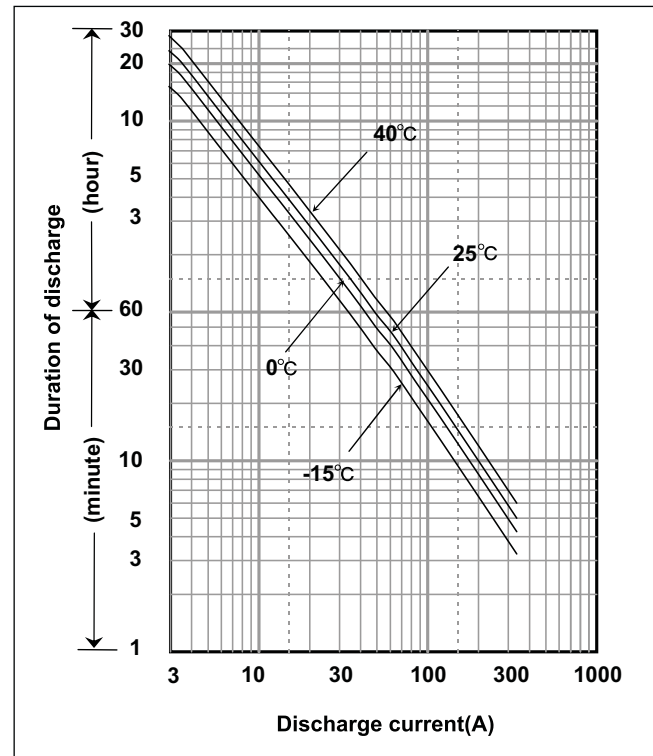

Watt Table

Cut-off V	(Wattage/Battery)														
	10min	15min	20min	30min	45min	1h	1.5h	2h	3h	4h	5h	6h	10h	20h	24h
9.6V	2987	2270	1872	1391	1017	793	578	482	353	279	232	197	124	63.7	54.4
9.9V	2920	2215	1827	1358	995	772	563	469	346	273	225	192	120	63.7	54.4
10.2V	2855	2136	1761	1314	984	751	548	463	340	267	218	186	118	63.0	53.7
10.5V	2764	2110	1748	1303	968	730	532	453	334	264	218	186	117	63.0	53.7
10.8V	2522	2010	1739	1261	933	720	525	442	328	258	212	183	116	61.6	52.6

Ampere Table

Cut-off V	(Ampere/Battery)														
	10min	15min	20min	30min	45min	1h	1.5h	2h	3h	4h	5h	6h	10h	20h	24h
9.6V	272	212	175	133	96.7	76.7	53.6	43.2	30.2	23.3	19.7	16.1	10.2	5.50	4.51
9.9V	269	211	174	132	94.0	76.4	52.6	42.8	29.6	23.1	19.4	16.1	10.2	5.50	4.51
10.2V	268	210	172	130	93.5	75.9	52.1	42.3	29.4	22.9	19.1	16.0	10.1	5.50	4.51
10.5V	245	198	164	128	92.5	75.4	51.5	41.8	29.4	22.9	19.1	16.0	10.1	5.50	4.51
10.8V	232	192	160	126	79.9	65.4	46.4	39.7	28.1	22.3	18.9	15.5	9.99	5.39	4.51

Charging Method

Trickle Use	Control voltage: 13.6 - 13.8V; Initial current: 16.5A or smaller
-------------	---

Influence of Temperature on Trickle life

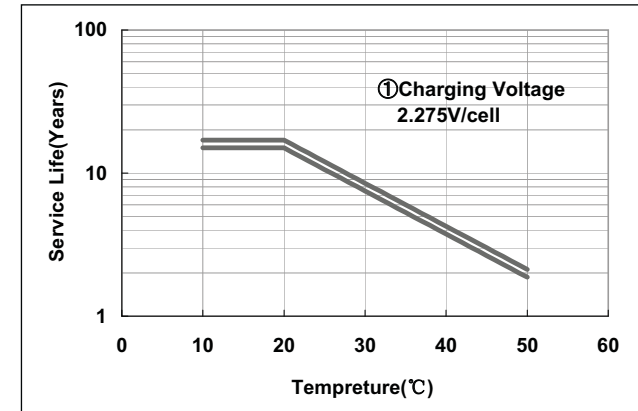

Cut off voltage

Discharge current	5.5A - 22A	22A - 55A	55A - 110A	110A - 220A	220A - 330A
Cut off voltage (V)	10.5	10.2	9.9	9.3	8.7

Residual capacity test result

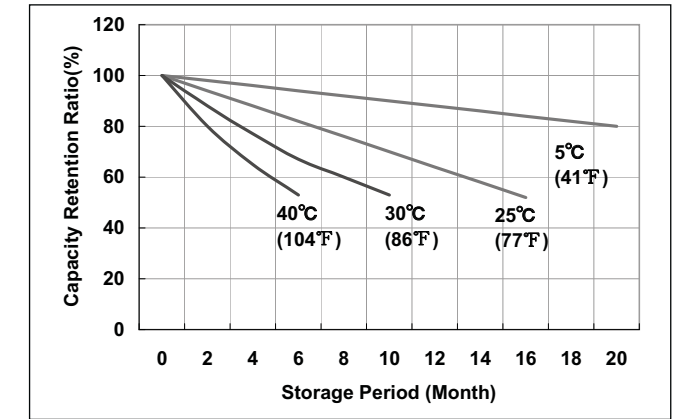

Constant-voltage and constant-current charge characteristics

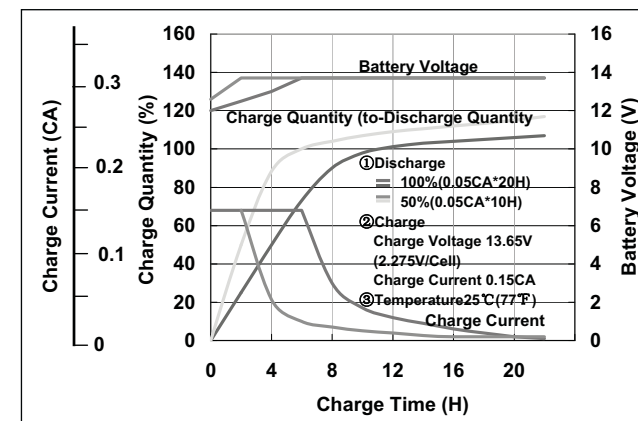

Discharge capacity by temperature and by discharge current

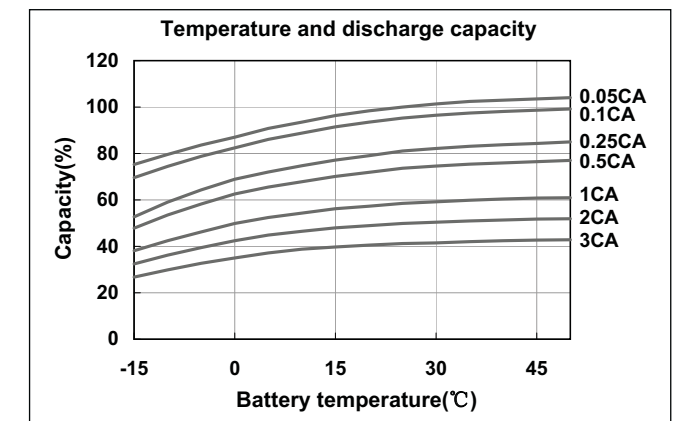

Discharge characteristics

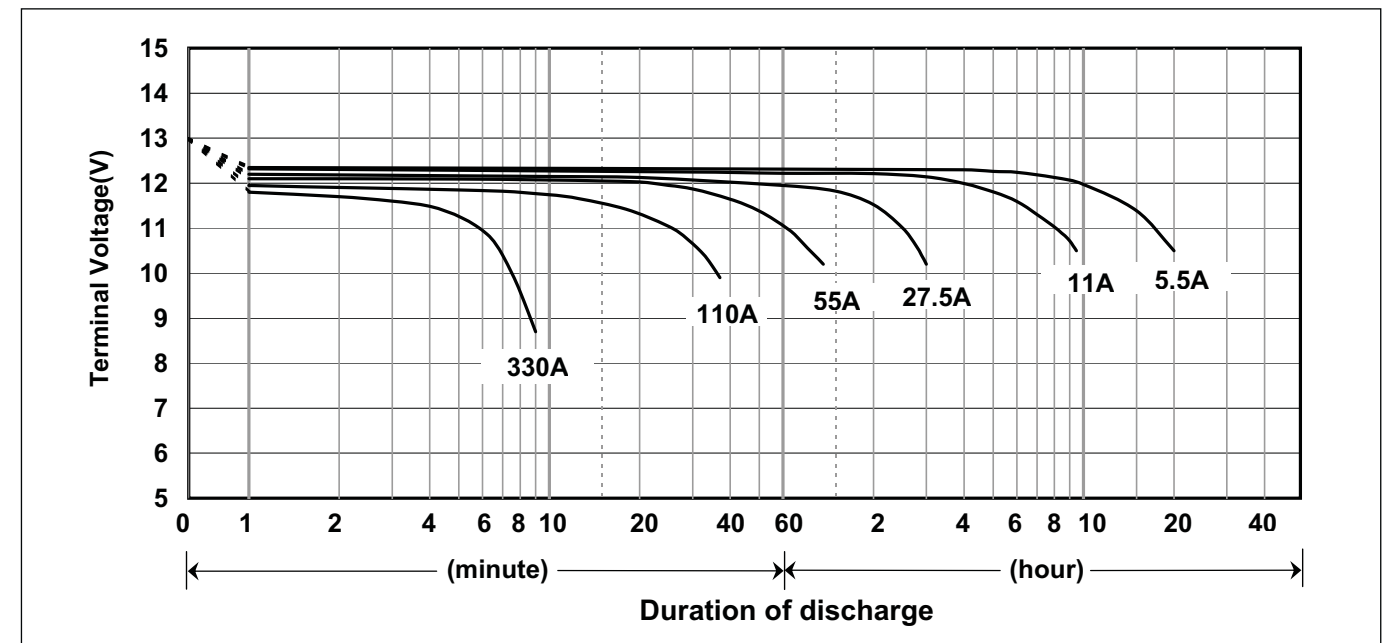

14 | Glossary of Main Battery Terms

ABS RESIN

A plastic material largely used for the case and cover of batteries.

ACTIVE MATERIAL

The substance which electrochemically reacts in the electrode of batteries. Lead-acid batteries adopt lead dioxide for the positive electrode and spongy lead for the negative electrode.

AMBIENT TEMPERATURE

Average temperature in the vicinity of the battery.

AVAILABLE CAPACITY

The capacity actually available from a cell/battery. The available capacity is the capacity of a battery when it discharges at a specified hour rate, and expressed in hour rate andAh.

BOLT FASTENING TERMINAL

A type of battery terminals, to which lead wires are connected with bolts.

BUILT-IN THERMOSTAT

The built-in thermostat is a resettable switch built in a battery for temporarily cut off the battery circuit when the temperature of the battery exceeds a preset value or when the battery charges/discharges at a higher rate than predetermined.

CAPACITY

The electric capability of a battery. It usually means ampere-hour capacity expressed inAh or C (coulomb).

CELL

The minimum battery unit which composes a storage battery. Nominal voltage of the cell of the lead-acid battery is 2V.

CHARGE

The operation of supplying a battery with a DC current from an external power source to have the electrode active materials conduct chemical reactions then to store electric energy as chemical energy in the battery.

CHARGEACCEPTANCE TEST

Test of batteries to check whether or not they are adequately recharged after discharge.

CHARGING EFFICIENCY

General term for ampere-hour efficiency and watthour efficiency. In many cases, however, it means the ampere-hour efficiency.

CONSTANT CURRENT CHARGE

A method of charging: to charge a battery with a constant current.

CONSTANT VOLTAGE CHARGE

A method of charging: to charge a battery by applying a constant voltage to the terminals.

C-RATE

A charge or discharge current rate expressed inA or mA. It is numerically the same as the hour rate capacity of a battery expressed inAh of the rated capacity.

CUT-OFF VOLTAGE OF DISCHARGE

The terminal voltage of a battery at which discharging should be discontinued. This voltage depends on discharge current, type of electrodes and construction of battery.

CYCLE LIFE

The number of charge/discharge/rest cycles a cell/battery can provide. Cycle life is usually expressed by the number of cycles available before duration of discharge decreases to a half of the initial value.

DEPTH OF DISCHARGE

A value to express the state of discharge of a battery. The depth of discharge is generally expressed by the ratio of discharge amount to rated capacity of the battery.

DISCHARGE

To draw off the electric energy stored in a cell/battery.

DISCHARGE RATE

The term to express the magnitude of discharge current. When assuming discharge current and time to discharge cut-off voltage t hours, this discharge is called t hour rate (tHR) discharge, and the current is called t-hour rate discharge current. When time t is minutes instead of hours, tMR is used.

DUTY CYCLE TEST

Test of batteries in ordinary use including charge, discharge and rest.

ELECTROLYTE

The medium which serves to conduct ions in the electrochemical reactions in batteries. The leadacid battery adopts diluted sulfuric acid as the electrolyte.

ENERGY DENSITY

Energy available per unitApprox. mass or unit volume of a cell/ battery. Energy density is expressed in Wh/kg or Wh/l.

FLOAT CHARGE

The system in which a constant voltage is continuously applied to a battery connected to a rectifier in parallel with a load to maintain the battery in charged state: on occurrence of power failure or load variation, the battery supplies power to the load without any short break.

GAS RECOMBINATIONABILITY

Capability of a battery to recombine (or absorb) internally generated oxygen gas at the negative plate. The greater this capability is, the larger the available charge current.

HIGH RATE DISCHARGE

A very rapid discharge of a battery. (In many cases it means discharging at approx. 1 CA or higher rate.)

INTERNAL PRESSURE

The pressure within a sealed battery. Internal pressure of a battery is increased by oxygen gas which is generated from the positive plate at the end of charging.

INTERNAL RESISTANCE

The resistance within a battery: it is the total of individual resistances of the electrolyte and the positive and negative plates. Internal resistance is simply measured with the current four-terminal method (1,000 Hz) and expressed in the composite value of resistance component and capacitor component.

INTERNAL SHORT-CIRCUIT

Touching of the positive and negative plates within a cell.

LIFE

The time period until a cell/battery loses its expected characteristics.

LOW MAINTENANCE

Low maintenance means that no watering nor equalizing charge is required in operating batteries.

LOW-VOLTAGE CUT-OFF

A circuitry designed to discontinue discharge of a battery at a predetermined voltage level.

MALE TAB

The metallic pieces which are attached to a SLA battery as the terminals.

MEMORY EFFECT

A phenomenon where a temporary drop of discharge voltage is observed during deep discharge of an alkaline rechargeable battery which has been subjected to shallow charge/discharge. Cycles or trickle charging over long time.

14 | Glossary of Main Battery Terms

NEGATIVE PLATE

The battery electrode into which a current from the external circuit flows during discharging. The negative plate has lower electric potential than the positive plate to the electrolyte. The negative plate is incorporated with connection parts such as the electrode pole.

RATED CAPACITY

A nominal value of capacity of a cell/battery, which is a measure of electric capability. Rated capacity is rather approximate compared with rated capacity.

NOMINAL VOLTAGE

A nominal value to indicate the voltage of a cell battery. Generally, nominal voltage value of a battery is somewhat lower than its electromotive force. Nominal voltage of the lead-acid battery is 2.0V per unit cell.

OPEN CIRCUIT VOLTAGE

Measured voltage of a cell/battery which is electrically disconnected from the external circuit.

OVERCHARGE

Continued charging of a fully charged cell/battery. With batteries which require watering, overcharge causes electrolysis of water, resulting in rapid decrease of electrolyte. Generally, overcharge adversely influences battery life.

OVERDISCHARGE

Discharge of a battery to a voltage below a predetermined cut-off voltage.

PARALLEL CHARGE

Simultaneous charging of two or more batteries connected in parallel. In cyclic use of batteries, specifically, the parallel charge tends to cause an imbalance in charge state among the batteries, which may shorten their service life.

POLYPROPYLENE RESIN

A plastic material which is often used for the case and cover of batteries.

POSITIVE PLATE

The battery electrode from which a current flows to the external circuit during discharging. The positive plate has higher electric potential than the negative plate to the electrolyte. The positive plate is incorporated with connection parts such as the electrode pole.

QUICK CHARGE (RAPID CHARGE)

Charging in a short time with a large current.

RATED CAPACITY

The stated capacity of a battery; namely, the ampere-hour amount which can be drawn from the battery in fully charged state at a specified temperature, at a specified discharge rate, and to a specified cut-off voltage. The symbol CN may be used to express the rated capacity of N-hour rate.

RECHARGEABLE BATTERY

The rechargeable battery is a system comprising two different electrodes and an ion-conductive medium, which is capable of converting chemical energy to electric energy, and vice versa. It is also called a secondary battery.

REFRESH CHARGE (AUXILIARY CHARGE)

Charging of a battery mainly to compensate for its self discharge.

RESIDUAL CAPACITY

Residual capacity of a battery after partial discharge or after storage for long time.

RETAINER TYPE

A method to control flowing electrolyte in a battery with the retainer mat, etc...

REVERSE CHARGE

Charging of a battery with its polarity reversed. Namely, the battery discharges.

SELF DISCHARGE

Reduction in capacity of a battery while no current is drawn by the external circuit. Self discharge depends on temperature: amount of discharge approximately doubles by each (10°C) rise of ambient temperature.

VALVE REGULATED LEAD-ACID BATTERY (VRLA-BATTERY)

Valve regulated lead-acid battery.

SEPARATOR

A porous or microporous liquid-absorbent material which is installed between the battery electrodes for preventing short-circuit, securing the separation of the electrodes and retaining electrolyte. The separator should be resistant to oxidation and chemicals; it should excel in electric insulation and liquid-retention; and it should not disturb diffusion of the electrolyte and ionic conduction.

STANDBY USE

General term of constant stand-by battery systems. Batteries are kept charged by trickle/float method at all times in preparation for unforeseen power disruptions.

TEMPERATURE COMPENSATION

Compensation of charge voltage for temperature variation of a cell/battery or in its vicinity. Qualitatively, charge voltage should be corrected to higher side for low temperatures and to lower side for high temperatures.

TERMINAL VOLTAGEAT DISCHARGE

The voltage of a battery during discharging.

THERMAL RUNAWAY

Such phenomena as an excessively high set-up voltage in constant-voltage charging of a battery and a very high battery temperature cause charge current to increase, which then raises the temperature further: this vicious cycle is called thermal runaway, which may, in the worst case, result in breakage of the battery due to heat.

TRICKLE CHARGE

To charge a battery in the state of disconnection from the load to compensate for its self discharge.

TRICKLE LIFE

The service life of a battery in the trickle use. Usually, the trickle life is the time expressed in years before the dischargeable time of the battery decreases to a half of the initial value.

UL

Abbreviation of Underwriters Laboratories Inc. in USA. The UL establishes various safety standards, and performs official recognition of materials, parts and products.

UPS (Uninterruptible Power Supply)

Equipment or system which is automatically connected to the load to supply power if the main power fails.

VENT (ONE WAY VALVE)

A valve on each battery which automatically releases gas from the battery when internal pressure of the battery exceeds a predetermined value: it prevents breakage of the battery due to excessive internal pressure caused by the gas generated by charging or other reasons. The valve also serves to prevent outside air from entering batteries.

CONTACT

United Kingdom/Ireland

Panasonic Industrial Europe GmbH
Willoughby Road
Bracknell Berkshire
RG12 8FP
England
Phone: +44 1344 - 853260
Fax: +44 1344 - 853313

Italy

Panasonic Italia S.p.A.
Viale dell'Innovazione 3
20125 Milano
Italy
Phone: +39 02 - 6788 - 506
Fax: +39 02 - 6788 - 207

Spain/Portugal

Panasonic Industrial Europe GmbH
Sucursal en España
Parque Empresarial @ Sant Cugat,
Via Augusta 15-25
Edificio B2 Planta 4 Oficina 17
08174 Sant Cugat del Vales
Barcelona
Spain
Phone: +34 93 - 504 30 10
Fax: +34 93 - 675 58 92

France

Panasonic France S.A.S
1-3 Avenue François Mitterrand
93218 Saint-Denis La Plaine, Cedex
France
Phone: +33 1 - 55 93 67 18
Fax: +33 1 - 55 93 67 90

Germany

(all other European countries)

Panasonic Industrial Europe GmbH
Winsbergring 15
22525 Hamburg
Germany
Phone: +49 40 - 85386 - 373
Fax: +49 40 - 85386 - 238

E-mail and Website for all countries

battery-solutions@eu.panasonic.com
<http://industrial.panasonic.com/eu>

Notice to Readers

It is the responsibility of each user to ensure that every battery application is adequately designed safe and compatible with all conditions encountered during use, and in conformance with existing standards and requirements. This literature contains information concerning cells and batteries manufactured by Panasonic Corporation. This information is generally descriptive only and is not intended to make or imply any representation, guarantee or warranty with respect to any cells and batteries. Cell and battery designs are subject to modification without notice.

This catalog has been produced using unchlorinated paper.

For more details please contact:

Panasonic

Panasonic is a registered trademark
of Panasonic Corporation.
Printed in Germany.
© Panasonic Corporation